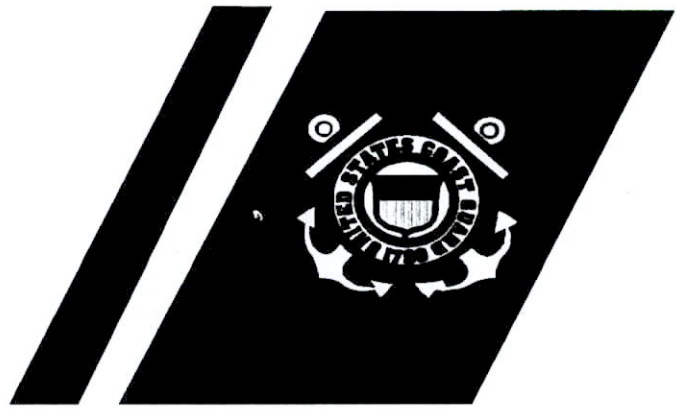


U.S. Department
of Transportation

United States
Coast Guard



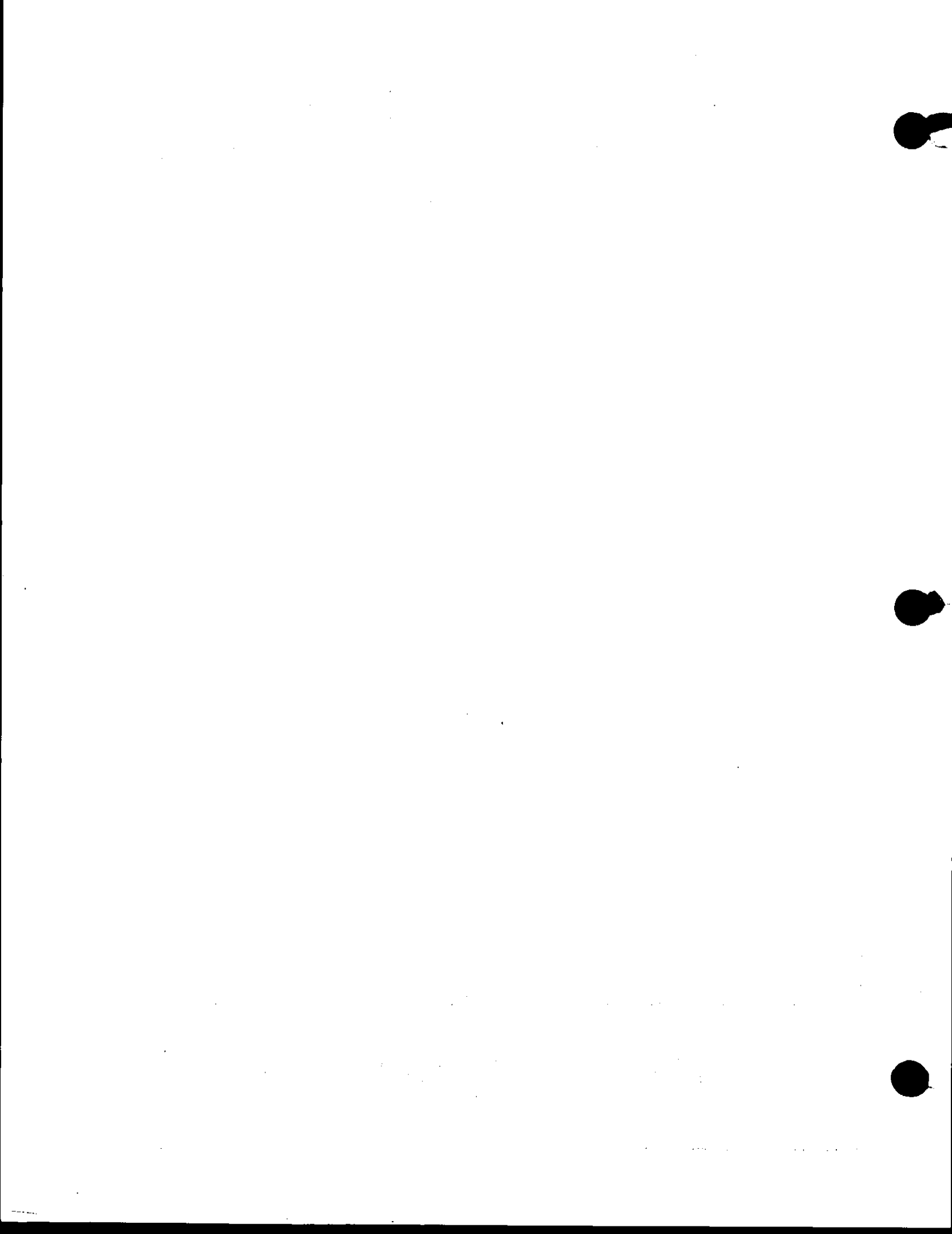
TECHNICAL MANUAL

FOR

AN/FPN-60(V) AND AN/FPN-60A(V) SERIES

TRANSMITTER CONTROL SETS

EFFECTIVE SEPTEMBER 1984



RECORD OF CHANGES

CHANGE NO.	DATED	TITLE OR BRIEF DESCRIPTION	ENTERED DATE BY
FC # 1 FC # 2 FC # 3 FC # 4 FC # 5 FC # 7 FC # 8 FC # 9	22 AUG 1977 7 OCT 1977 13 APR 1979 30 APR 1979 29 JAN 1981 05 Apr 95 NONE 13 AUG 1993 12 MAR 1996	ELEVATE P.C. TO EQ. LEVEL ADDS E.P.A. MODIFIES E.P.A. INCREASE RESOLUTION ROS Medications NEW NOMENCLATURE PLATES RE-ISSUE OF DOCUMENTATA ADDS TEST POINTS	26 June 95 B. Gokhlong 18 DEC 96 R. MATTINGLY 18 DEC 96 R. MATTINGLY 19 DEC 96 R. MATTINGLY

NEEDS
 FPN-60
 F/C 6 BULLETIN
 F/C 10 BULLETIN
 F/C 11 BULLETIN
 FPN-60A
 F/C 2 & 3



U.S. Department
of Transportation

United States
Coast Guard



Commanding Officer
United States Coast Guard
Loran Support Unit

12001 Pacific Avenue
Wildwood, NJ 08260-3232
Staff Symbol: SMEF
Phone: (609) 523-7275
FAX: (609) 523-7264

OCT 10 1997

ERRATA SHEET NO. 1

TO

F. C. NO. 9 TYPE 1 TO AN/FPN-60(V)/AN/FPN-60A(V) TRANSMITTER CONTROL SET

PURPOSE:

This errata sheet provides pen and ink corrections to Field Change Bulletin No. 9 to the AN/FPN-60(V)/AN/FPN-60A(V) Transmitter Control Set and the Step-by-step Installation Instructions provided as Enclosure (1) to the field change.

PROCEDURE:

1. Locate the Field Change Bulletin No. 9 to the AN/FPN-60(V)/AN/FPN-60A(V) Transmitter Control Set and make the following pen and correction to the heading on page 1:

Change:

“F. C. NO. 9 TYPE 1 TO AN/FPN-60(V)/AN/FPN-60A(V) TRANSMITTER CONTROL SET”

To read:

“F. C. NO. 9 TYPE 1 TO AN/FPN-60(V) TRANSMITTER CONTROL SET

F.C. NO. 1 TYPE 1 TO AN/FPN-60A(V) TRANSMITTER CONTROL SET”

DISTRIBUTION – SDL No. 135

	a	b	c	d	e	f	g	h	i	j	k	l	m	n	o	p	q	r	s	t	u	v	w	x	y	z
A																										
B	*		*		2				*									12	5			1				
C																						*				
D																										
E									1																	
F																										
G																										
H																										

NON-STANDARD DISTRIBUTION:

Ba: COMDT(G-OPN-3, G-SCE, G-SCE-2) (1)

Bc: MLCLANT(tst), MLCPAC(ts-2) (2)

Bi: ELC (Ordnance Road) (2); ELC (Hawkins Point Road, mark for Code: ESL) (2); ELC (Hawkins Point Road, mark for Code: 016, CGPMS Manager) (2)

Cv: LORSTAs (Attu, Dana, Fallon, George, Middletown, Kodiak, Port Clarence, Searchlight, Shoal Cove, St. Paul, and Tok) (2)

Dt: ESU (Alameda, Cleveland, Kodiak, Miami, New Orleans, Portsmouth, Seattle, St. Louis) (1)

2. Locate Enclosure (1) to Field Change Bulletin No. 9 to the AN/FPN-60(V)/AN/FPN-60A(V) Transmitter Control Set, and make the following pen and correction to page 5, step 2.2:

Between steps (c) and (e), add:

- d. Connect jumper wire between TP2 (orange) to TP6 (black) of the operate timer Error Sense (M) board. Dual-rated stations must connect jumper on both operate timers to prevent Cycle Compensation activity.

ROUTINE INSTRUCTIONS:

Upon completion, attach this errata sheet in front of Field Change Bulletin No. 9 to the AN/FPN-60(V)/AN/FPN-60A(V). Copies of this errata sheet may be obtained from Coast Guard Engineering Logistic Center, Baltimore, MD. Order directly, using MILSTRIP procedures; no cost is involved. National Stock Number CG 7610-01-GE8-1760 applies.



C. A. SCHUE, III

Non-Standard Distribution (Continued from Page 1)

Coordinator Of Chain Operations
USCG Loran Station Kodiak
P.O. Box 190032
Kodiak, AK 99619-0032 (2 copies)

Coordinator Of Chain Operations
Canadian Coast Guard
Box 693
St. Anthony, Newfoundland
Canada A0K 4S0 (2 copies)

Coordinator Of Chain Operations
USCG NAVCEN
7323 Telegraph Rd
Alexandria, VA 22310-3998 (2 copies)

Coast Guard Telcom
Electronics Directorate
The Canada Building
344 Slater St.
Ottawa, Ontario K1A0N7
ATTN: AMTJ-E (2 copies)

Coordinator Of Chain Operations
USCG NAVCEN Detachment
C/O USCG TRACEN Petaluma
599 Tomales Road, Building 130
Petaluma, CA 94952-5000 (2 copies)

Canadian Coast Guard
Coordinator of Chain Operations (FMYDD)
PO Box 4670 STN
Williams Lake, British Columbia
Canada V2G 2V7 (2 copies)

Station Manager
Williams Lake Loran C Station
PO Box 4568
Williams Lake, British Columbia
Canada V2G 2V8 (2 copies)

Lormonsta
Canadian Coast Guard
Box 693
St. Anthony, Newfoundland
Canada A0K 4S0 (2 copies)

Non-Standard Distribution (Continued from Page 2)

Telecom Maintenance Manager
Canadian Coast Guard
Fox Harbour Loran C Station
St. Lewis, Labrador, NF
Canada AOK 4W0 (2 copies)

Telecom Station Manager
Ship Electronic Workshop
Canadian Coast Guard Base
PO Box 1270
Charlottetown, PEICIA
Canada AOG 3A0 (2 copies)

Telecom Maintenance Manager
Loran Transmitting Station
Canadian Coast Guard, Box 1180
Port McNeil, British Columbia
Canada VON 2R0 (2 copies)

Commanding Officer
USCG NAVCEN Detachment
C/O USCG TRACEN Petaluma
599 Tomales Road, Building 130
Petaluma, CA 94952-5000 (2 copies)



P 291725Z AUG 97

13:40:02 Aug 29, 97

C4 L9 DE NC

C4/002320 L9/COGARD LSU WILDWOO:000061

C4 T COGARD ESU DET ATLANTIC CITY NJ

C4 T COGARD ESU DET CAPE MAY NJ

P 291725Z AUG 97 ZUI ASN-GCM241000077

FM COGARD LSU WILDWOOD NJ

TO AIG FOUR NINE ONE FOUR

BT

UNCLAS //N16565//

SUBJ: LSU SMEF ADVISORY, SER: 97-03

1. INSTALLATION INSTRUCTIONS FOR FIELD CHANGE 9 TO THE AN/FPN-60(V) TRANSMITTER CONTROL SET ARE MISSING THE STEP TO GROUND THE CYCLE COMPENSATION LOOP BEFORE REMOVING POWER TO THE C-9888/FPN-60(V) TRANSMITTER COUPLER CONTROL (TCC). WITHOUT THIS STEP AN OUT OF TOLERANCE CONDITION MAY OCCUR.
2. THE OPERATE AN/FPN-54A OR AN/FPN-65 TIMER MUST BE PLACED IN LOCAL CONTROL AND A JUMPER WIRE INSTALLED BETWEEN TP2 (ORANGE) AND TP6 (BLACK) OF THE OPERATE TIMER ERROR SENSE (M) BOARD BEFORE REMOVING POWER TO THE TCC, STEP 2.3 OF THE INSTALLATION INSTRUCTIONS. DUAL-RATED STATIONS MUST CONNECT A JUMPER ON BOTH RATES OPERATE TIMERS TO PREVENT CYCLE COMPENSATION ACTIVITY.
3. THE JUMPER WIRE INSTALLED IN THE AN/FPN-54A OR AN/FPN-65 TIMER(S) NEEDS TO BE REMOVED AND THE TIMER(S) PLACED IN REMOTE CONTROL AFTER THE TCC IS FUNCTIONING PROPERLY.
4. ATTACH THIS SMEF ADVISORY TO THE FRONT OF FIELD CHANGE 9 TO THE AN/FPN-60(V).
5. LSU POINT OF CONTACT IS ET1 TANGUAY AT (609)523-7275.

BT

NNNN



~~CONFIDENTIAL~~



ELECTRONIC FIELD CHANGE BULLETIN

12 MAR 1986

F. C. NO. 9 TYPE 1 TO AN/FPN-60(V)/~~AN/FPN-60A(V)~~ TRANSMITTER CONTROL SET

F.C. NO. 1 TYPE 1 TO AN/FPN-60A(V) TRANSMITTER CONTROL SET
PURPOSE:

The purpose of this field change is to provide easy access rear panel test points for measuring the DC power supplies in the C-9888/FPN-60(V) Transmitter Coupler Control, SG-1099/FPN-60(V) Pulse Generator, and the TS-3550/FPN Electrical Pulse Analyzer.

DESCRIPTION:

This field change consists of installing five test points in the rear panel of the C-9888/FPN-60(V) Transmitter Coupler Control and the TS-3550/FPN Electrical Pulse Analyzer for measuring PS1 and PS2. Four test points are installed in the SG-1099/FPN-60(V) Pulse Generator for measuring PS1.

EQUIPMENT AFFECTED:

All AN/FPN-60(V) and AN/FPN-60A(V) Loran-C Local Status Monitor Sets are affected by this field change.

IDENTIFICATION OF ACCOMPLISHMENT:

Accomplishment of this field change can be identified by the presence of voltage test points mounted in the rear panel of the C-9888/FPN-60(V) Transmitter Coupler Control, SG-1099/FPN-60(V) Pulse Generator, and the TS-3550/FPN Electrical Pulse Analyzer.

DISTRIBUTION - SDL No. 133

	a	b	c	d	e	f	g	h	i	j	k	l	m	n	o	p	q	r	s	t	u	v	w	x	y	z
A																										
B	*		*		2				*									10	5			1				
C																						*				
D																				*						
E								*																		
F																										
G																										
H																										

NON-STANDARD DISTRIBUTION:

Ba: COMDT(G-NRN, G-TES, G-TES-2, G-TES-3, G-TES-3/CGPMS, G-TES-4) (1)

Bc: MLCLANT(tst) and MLCPCAC(tes) (2)

Bi: SUPCEN Baltimore (2)

Cv: LORSTAs(Attu, Dana, Fallon, George, Middletown, Kodiak, Port Clarence, Searchlight, Shoal Cove, St. Paul, and Tok) (2)

MATERIALS REQUIRED:

1. Single-rated stations will require Field Change No. 9 Bulletin Parts Kit A, Activity Control Number (ACN) CG 5825-01-GL7-5697. A list of parts contained in the parts kit is provided as enclosure (2) to this bulletin.
2. Dual-rated stations will require Field Change No. 9 Bulletin Parts Kit B, Activity Control Number (ACN) CG 5825-01-GL7-5698. A list of parts contained in the parts kit is provided as enclosure (3) to this bulletin.

TOOLS REQUIRED:

50 ohm dummy load, rack mounted
Crimping tool
Drill Portable, Electric
Drill, twist: 1/4 inch
File, Hand
Hammer
Heat gun
Multimeter, digital
Nut driver, 1/4"
Oscilloscope and 2 calibrated X10 scope probes
Solder station
Solder
Safety goggles
Stripper, wire
Pliers, straight nose
Punch, center
Screwdriver: short flat tip
Screwdriver: short phillips tip
Screwdriver: medium flat tip
Wire cutter
Wire labels
Wrench, adjustable, 4 inch
Reamer, hand
Vacuum cleaner

PROCEDURES:

1. **SINGLE-RATED STATIONS ONLY:** Using MILSTRIP procedures order Field Change No. 9 Bulletin Parts Kit A, ACN CG 5825-01-GL7-5697 applies. There is no cost involved.
2. **DUAL-RATED STATIONS ONLY:** Using MILSTRIP procedures order Field Change No. 9 Bulletin Parts Kit B, ACN CG 5825-01-GL7-5698 applies. There is no cost involved.
3. Follow the Step-by-step installation instructions provided as enclosure (1) to install this field change in the AN/FPN-60(V) or the AN/FPN-60A(V) Series Transmitter Control Set.

4. Follow the instructions provided as enclosure (5) to correct the technical manual for AN/FPN-60(V) Series Transmitter Control Set.

5. Follow the instructions provided as enclosure (4) upon completion of this field change.

ROUTINE INSTRUCTIONS:

1. Record completion of this field change by making an entry on the Field Change Accomplished Plate, NSN OI 0264-LP-085-0000 (available from the Naval Publications and Forms Center, Philadelphia, PA).

2. Maintenance support facilities shall maintain a library copy of this and all other applicable field change bulletins. Additional and replacement copies can be obtained from Coast Guard Supply Center, Baltimore, MD (Code 341). Order directly, using MILSTRIP procedures; no cost is involved. NSN CG 7610-01-GE8-1758 applies.

3. Upon completion, a copy of this field change bulletin shall be inserted in the front of all applicable technical manuals. Cognizant commands shall ensure that the field change has been accomplished and that applicable reports have been made.

F. A. ADAMS

- Encl: (1) Step-by-step Installation Instructions for AN/FPN-60(V)/AN/FPN-60A(V) Transmitter Control Set
(2) Parts List for Field Change No. 9 Bulletin Parts Kit A
(3) Parts List for Field Change No. 9 Bulletin Parts Kit B
(4) EECEN Field Change Installation Questionnaire
(5) Technical Manual Corrections to the AN/FPN-60(V) Series Transmitter Control Set Technical Manual

Non-Standard Distribution (Continued from page 1)

Dt: ESUs(Alameda, Seattle, and Kodiak) (1)

Eh: EMDs(Boston, Portsmouth, Miami, Cleveland, New Orleans, and St. Louis) (1)

Chain Coordinator
c/o USCG Support Center
P.O. Box 32
Kodiak, AK 99619-5000
(2 Copies)

Chain Coordinator
USCG Loran C Station
P.O. Box 387
Malone, FL 32445-0387
(2 Copies)

Chain Coordinator
USCG Loran C Station
Box 28
Romulus, NY 14541-0028 (2 Copies)

Chain Coordinator
Canadian Coast Guard
Box 693
St. Anthony, Newfoundland
Canada AOK 4S0 (2 Copies)

Coast Guard Telcom
Electronics Directorate
The Canada Building
344 Slater St.
Ottawa, Ontario K1A 0N7
Attn: AMTJ-E (2 Copies)

Supervisor
USCG Navigation Center Detachment
Training Center Petaluma, Bldg 130
Petaluma, CA 94952-5000 (2 Copies)

Chain Coordinator (FMYDD)
Canadian Coast Guard
P.O. Box 4670 STN Main
Williams Lake, British Columbia
Canada V2G 2V7 (2 Copies)

Chain Coordinator
USCG Loran C Station
Middletown, CA 95461-9999
(2 Copies)

Station Manager
Williams Lake Loran C Station
PO Box 4568
Williams Lake, British Columbia
Canada V2G 2V8 (2 Copies)

**STEP-BY-STEP INSTALLATION INSTRUCTIONS FOR
AN/FPN-60(V)/AN/FPN-60A(V) TRANSMITTER CONTROL SET**

NOTES:

- a. The installation instructions are divided into three sections. Each section will pertain to an individual piece of equipment within the AN/FPN-60(V)/AN/FPN-60A(V) Transmitter Control Set. Section one will cover TS-3550/FPN Electrical Pulse Analyzer. Section two will cover C-9888/FPN-60(V) Transmitter Coupler Control. Section three will cover SG-1099/FPN-60(V) Pulse Generator.
- b. Using the field change bulletin and enclosures (2) or (3), verify all installation parts and tools required are available.
- c. Each section of this field change installation instruction will require approximately 2 hours to install.
- d. Observe all safety precautions outlined in COMDTINST M10550.25 Chapter 2.
- e. Read all instructions before attempting to install this field change.

Section 1: Installation Instructions for the TS-3550/FPN Electrical Pulse Analyzer (EPA).

- 1.1 Using wire markers, label the cables attached to rear panel of the EPA.
- 1.2 Prepare associated equipment for maintenance:
 - a. Advise the Control Monitor Station that you will be performing maintenance on the EPA and you will be placing the Timers in local control and the Local Site Operating System (LSOS) will be in Station Maintenance.
 - b. Place LSOS in Station Maintenance mode.
 - c. Place Timers in Local Control.
 - d. Connect jumper wire between TP2 (orange) to TP6 (black) of the operate timer Error Sense (M) board. Dual-rated stations must connect jumper on both rates to prevent Cycle Compensation activity.
 - e. Place Transmitter in Local Control.
- 1.3 Secure power to the EPA.
- 1.4 Disconnect all cables from the EPA and connect the cable removed from J7 into the rack mounted EPA Junction Box (dummy load). Dress all other cable out of the way.

ENCLOSURE (1)

1.5 Remove the four rack mounting screws and remove the EPA from the Transmitter Control Set.

1.6 Placing the EPA on a test/work bench and remove the top cover by loosening the captive hardware fasteners.

1.7 Remove the four screws that mount Power Supply 1 (PS1) to the chassis. Remove all printed circuit boards (PCBs) from the chassis and dress the internal wiring so that the back of the chassis can be safely worked on.

1.8 Clean the area the Test point label, parts kit item #12, will be applied to and attach the label as per Figure 1.

NOTE:

Safety goggles should be worn while performing steps 1.9-1.11

1.9 Using a center punch and hammer, mark a hole on the large plus signs (+) of the test point label.

1.10 Using an electric drill with an 1/4 inch twist drill, drill holes through the chassis on the punches made in step 1.9, taking care not to damage parts inside the chassis.

1.11 Remove the burrs from the holes using a small metal file and remove any metal shaving from the inside chassis using a vacuum cleaner.

1.12 Use Table 1 of Figure 1 for correct Tip jack color location. Mount the Tip jacks to the rear panel of the EPA using its associated star washer and bolt.

1.13 Strip, fasten, and solder the Red wire, parts kit item #1, to the Red tip jack, parts kit item #6.

1.14 Cut and place a 1/2-inch section of electrical insulating sleeving, parts kit item #11, over the soldered connection, ensure solder connection is completely covered. Use a heat gun to reduce the diameter of the heat shrink.

1.15 Repeat steps 1.13 and 1.14 for all four colored tip jacks; using the chart below:

TEST POINT#	TIP JACK COLOR	WIRE COLOR
TP2	Brown	Brown
TP3	Blue	Blue
TP5	Green	Green
TP4	Orange	Orange

1.16 Using Table 1 of Figure 1 for correct connections, route the Red, Brown, Blue, and Green wires attached to the Tip jacks to the appropriate terminal board points.

ELECTRICAL PULSE ANALYZER

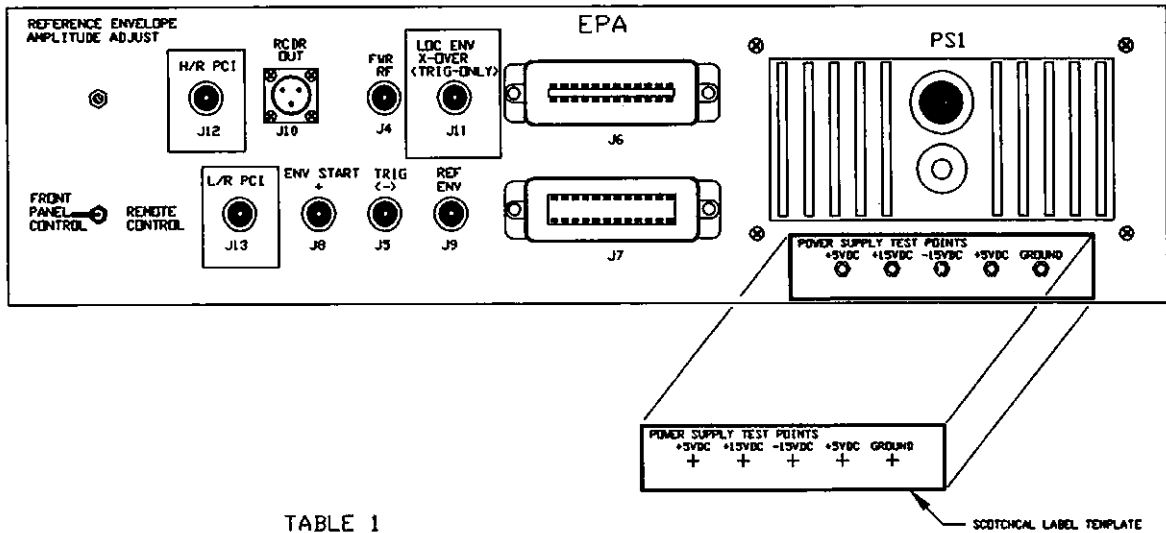


TABLE 1

EPA POWER SUPPLY CONNECTION POINT(S) FOR TEST JACKS			
POWER SUPPLY AND VOLTAGES	TB-1	TEST JACK DESTINATION	
PS1	+5VDC	PIN 2	TP1 RED
	+15VDC	PIN 6	TP2 BROWN
	-15VDC	PIN 4	TP3 BLUE
	GROUND	PIN-1	TP5 GREEN
PS2	+5VDC		SEE NOTE #1

NOTE 1

THE PS2 +5VDC WIRE IS CONNECTED DIRECTLY TO THE TP4 DRANGE TEST POINT

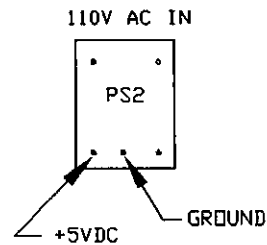


TABLE 2

	NOMINAL VOLTAGE	UPPER LIMIT	LOWER LIMIT	AC RMS RIPPLE
PS1	+5.0V	+5.25V	+4.75V	1.4mV
	+15.0V	+15.5V	+14.5V	2.8mV
	-15.0V	-15.5V	-14.5V	2.8mV
PS2	+5.0V	+5.50V	+4.50V	15mV

Figure 1

ENCLOSURE (1)

- 1.17 Cut all wires to an appropriate length to reach their respective points on the terminal board.
- 1.18 Crimp and solder a terminal lug, parts kit item #14, to the Red wire.
- 1.19 Repeat step 1.18 for the Blue, Brown and Green wire.
- 1.20 Using Table 1 of Figure 1 for correct connections, connect the Red, Brown, Blue, and Green wires terminal lug to the appropriate terminal board points.
- 1.21 Using Table 1 of Figure 1 for correct connection, route the Orange wire to power supply 2.
- 1.22 Cut the wire to an appropriate length to reach the +5VDC post of PS2.
- 1.23 Desolder the existing wire attached to the +5VDC post of PS2.
- 1.24 Twist the wire removed in step 1.23 together with the Orange wire and place a 1/2-inch piece of electrical insulating sleeving, parts kit item #11, over wires.
- 1.25 Solder the two wires to the +5VDC post of PS2. Use a heat gun to reduce the diameter of the heat shrink over the soldered connection.
- 1.26 Using the tiedown straps, parts kit item #13, dress all wiring as necessary.
- 1.27 Perform a continuity test by using a multimeter to measure between the tip jacks and wire connection points.
- 1.28 Reinstall PS1 and the PCBs removed in steps 1.7.
- 1.29 Apply AC power to EPA on the work bench. Using a multimeter verify the correct voltages correspond to each test point as indicated in Table 2 of Figure 1. Refer to the AN/FPN-60(V) Series Transmitter Control Set Technical Manual for power supply adjustments.
- 1.30 Remove AC power from the EPA, Replace the top cover tightening the captive hardware fasteners, install the EPA into the AN/FPN-60(V) Transmitter Control Set. Reinstall the rack mounting screws.
- 1.31 Reconnect all cables disconnected in step 1.4.
- 1.32 Reconnect AC power. Using both a digital multimeter and Oscilloscope check the power supply voltages and ripple, Refer to Table 2 of Figure 1 for proper voltage levels.
- 1.33 Verify the ECD and Peak Volts readings are normal. Verify all switches and connections are in their proper position.

1.34 Return equipment to normal configuration:

- a. Inside the Operate Timer remove the jumper wire from the Error Sense (M) board.
- b. Place Timers in Remote Control.
- c. Place Transmitter in Remote control.
- d. Place LSOS in Normal operating mode.
- e. Advise the Control Monitor Station that you have completed maintenance on the EPA and the Timers are in Remote control and the Local Site Operating System (LSOS) is in normal operating mode.

Section 2: Installation Instructions for the C-9888/FPN-60(V)
Transmitter Coupler Control (TCC)

2.1 Using wire markers, label the cables attached to rear panel of the TCC.

2.2 Prepare associated equipment for maintenance:

- a. Advise the Control Monitor Station that you will be performing maintenance on the TCC and you will be placing the timers in local control and the Local Site Operating System (LSOS) will be in Station Maintenance.
- b. Place LSOS in Station Maintenance mode.
- c. Place timers in local control.
- e. Place transmitter in local control.

d. Connect jumper between TP2 (orange) to TP6 (black) of the operate timer Error Sense (M) board. Dual-rated stations must connect jumper on both operate timers to prevent Cycle Comp activity.

2.3 Secure power to the TCC.

2.4 Disconnect all cables from TCC and connect the cable removed from J2 into the rack mounted TCC junction box (dummy load). Dress all other cable out of the way.

2.5 Remove the four rack mounting screws and remove the TCC from the Transmitter Control Set.

2.6 Placing the TCC on a test/work bench and remove the top cover by loosening the captive hardware fasteners.

2.7 Remove the four screws that mount power supply 1 (PS1) to the chassis. Remove the edge connector XPS1 from the power supply. Remove the power supply and dress the internal wiring so that the back of the chassis can be safely worked on.

2.8 Remove all printed circuit boards from the chassis.

2.9 Clean the area the test point label, parts kit item #26, will be applied to and attach the label as per Figure 2.

NOTE:

Safety goggles should be worn while performing steps 2.10-2.12

CONTROL, COUPLER-TRANSMITTER

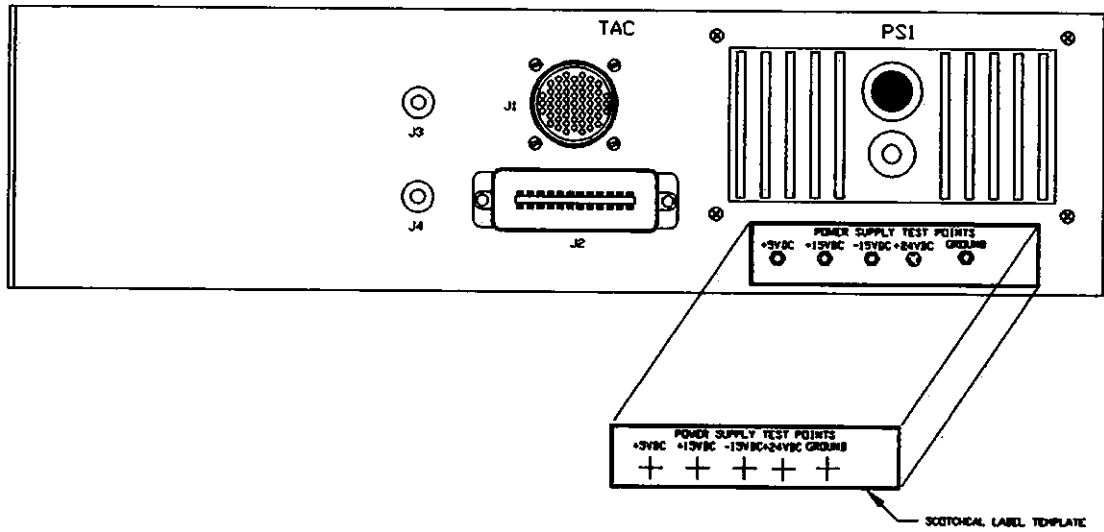


TABLE 1

TCC POWER SUPPLY WIRE HOOK-UP CONNECTION POINT(S) FOR TEST JACKS				
POWER SUPPLY AND VOLTAGES	CONNECTOR (XPS1)	TEST JACK DESTINATION		
PS1	+5VDC	PIN 12	TP1	RED
	+15VDC	PIN 2	TP2	BROWN
	-15VDC	PIN 3	TP3	BLUE
	GROUND	PIN 1	TP5	GREEN
PS2	+24VDC	SEE NOTE 1	TP4	ORANGE

NOTE 1

The PS2 +24VDC wire is connected directly to the orange test point.

TABLE 2

	NOMINAL VOLTAGE	UPPER LIMIT	LOWER LIMIT	AC RMS RIPPLE
PS1	+5.0V	+5.25V	+4.75V	1.4mV
	+15.0V	+15.0V	+14.5V	2.8mV
	-15.0V	-15.5V	-14.5V	2.8mV
PS2	+24.0V	+24.5V	+23.5V	4.2mV

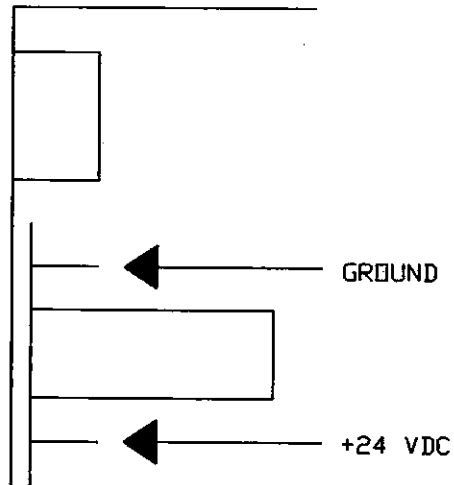


Figure 2

- 2.10 Using a center punch and hammer, mark a hole on the large plus signs (+) of the test point label.
- 2.11 Using an electric drill with an 1/4 inch twist drill, drill holes through the chassis on the punches made in step 2.10, taking care not to damage parts inside the chassis.
- 2.12 Remove the burrs from the holes using a small metal file and remove any metal shaving from the inside chassis using a vacuum cleaner.
- 2.13 Use Table 1 of Figure 2 for correct tip jack color location. Mount the tip jacks to the rear panel of the TCC using its associated star washer and bolt.
- 2.14 Strip, fasten, and solder the Red wire, parts kit item #15, to the Red tip jack, parts kit item #20.
- 2.15 Cut and place a 1/2-inch section of electrical insulating sleeving, parts kit item #25, over the soldered connection, ensure solder connection is completely covered. Use a heat gun to reduce the diameter of the heat shrink.
- 2.16 Repeat steps 2.14 and 2.15 for all four colored tip jacks; using the chart below:

TEST POINT#	TIP JACK COLOR	WIRE COLOR
TP2	Brown	Brown
TP3	Blue	Blue
TP5	Green	Green
TP4	Orange	Orange

- 2.17 On the edge connector XPS1, remove the heat shrink from pins 1, 3, and 12.
- 2.18 Form and route the Red, Brown, Green, and Blue wires along existing power supply edge connector wiring harness. Using tiedown straps, parts kit item #27, loosely tie the wires to maintain the route.
- 2.19 Connect tip jacks to XPS1:
- De-solder existing wiring on XPS1 pin 1.
 - Locate the Green wire from TP5, trim, strip, and twist together with the wire removed from pin 1.
 - Place a 1/2-inch length of electrical insulating sleeve, parts kit item #25, over the new pin 1 wire bundle.
 - Reconnect and solder the wires back to pin 1.
 - Place the electrical insulating sleeve over the soldered connection and use a heat gun to reduce the diameter of the electrical insulating sleeve.

ENCLOSURE (1)

2.20 Repeat step 2.19 for the following tip jacks:

<u>XPS1 CONNECTION</u>	<u>WIRE COLOR</u>	<u>TEST POINT#</u>
Pin 2*	Brown	TP2
Pin 3	Blue	TP3
Pin 12	Red	TP1

* There is no wire to desolder from Pin 2.

2.21 Using Table 1 of Figure 2 for correct connection, route the Orange wire to power supply 2 (PS2).

2.22 Desolder the existing wires attached to the +24VDC post of PS2.

2.23 Twist the wires removed in step 2.22 together with the Orange wire and place a 1/2-inch piece of electrical insulating sleeving, parts kit item #25, over wires.

2.24 Solder the new wire bundle to the +24VDC post of PS2. Using a heat gun, reduce the diameter of the heat shrink over the soldered connection.

2.25 Using the tiedown straps, parts kit item #27, dress all wiring as necessary.

2.26 Perform a continuity test by using an ohmmeter to measure between the test point jacks and power supply edge connector pins. Refer to Table 1 of Figure 2.

2.27 Attach XPS1, edge connector, to the PS1 and reinstall the power supply and PCBs removed in steps 2.7 and 2.8.

2.28 Apply AC power to TCC on the work bench. Using a multimeter, verify the correct voltages correspond to each test point as indicated in Table 2 of Figure 2. Refer to the AN/FPN-60(V) Series Transmitter Control Set Technical Manual for power supply adjustments.

2.29 Remove AC power from the TCC, replace the top cover tightening the captive hardware fasteners, install the TCC into the Transmitter Control Set. Reinstall the rack mounting screws.

2.30 Reconnect all cables disconnected in step 2.4.

2.31 Reconnect AC power. Using both a digital multimeter and oscilloscope check the power supply voltages and ripple. Refer to Table 2 of Figure 2 for proper voltage levels.

2.32 Verify all switches and connections are in their proper position and all proper indications are displayed.

2.33 Return equipment to normal configuration:

- a. Place timers in remote control.
- b. Place transmitter in remote control.
- c. Place LSOS in normal operating mode.
- d. Advise the Control Monitor Station that you have completed maintenance on the TCC and the timers are in remote control and the Local Site Operating System (LSOS) is in normal operating mode.

**Section 3: Installation Instructions for the SG-1099/FPN-60(V)
Pulse Generator (PGEN).****NOTES:**

a. This field change should be performed only on the PGEN(s) in the standby mode. The operate transmitter must be switched and placed in the standby mode to accomplish the installation on all PGEN(s).

b. Installation of this section will take approximately 2 hours per PGEN.

3.1 Using wire markers, label the cables attached to rear panel of the PGEN.

3.2 Prepare associated equipment for maintenance:

- a. Advise the Control Monitor Station that you will be performing maintenance on the PGEN and you will be placing the timers in local control and the Local Site Operating System (LSOS) will be in station maintenance.
- b. Place LSOS in station maintenance mode.
- c. Place timers in local control.
- d. Place transmitter in local control.

3.3 Secure power to the PGEN.

3.4 Disconnect all cables from the PGEN and dress all cables out of the way.

3.5 Remove the four rack mounting screws and remove the PGEN from the Transmitter Control Set.

3.6 Placing the PGEN on a test/work bench and remove the top cover by loosening the captive hardware fasteners.

3.7 Remove the four screws that mount power supply 1 (PS1) to the chassis. Remove the edge connector XPS1 from the power supply. Remove the power supply and dress the internal wiring so that the back of the chassis can be safely worked on.

3.8 Remove all printed circuit boards from the chassis.

3.9 Clean the area the test point label, parts kit item #37, will be applied to and attach the label as per Figure 3.

PULSE GENERATOR

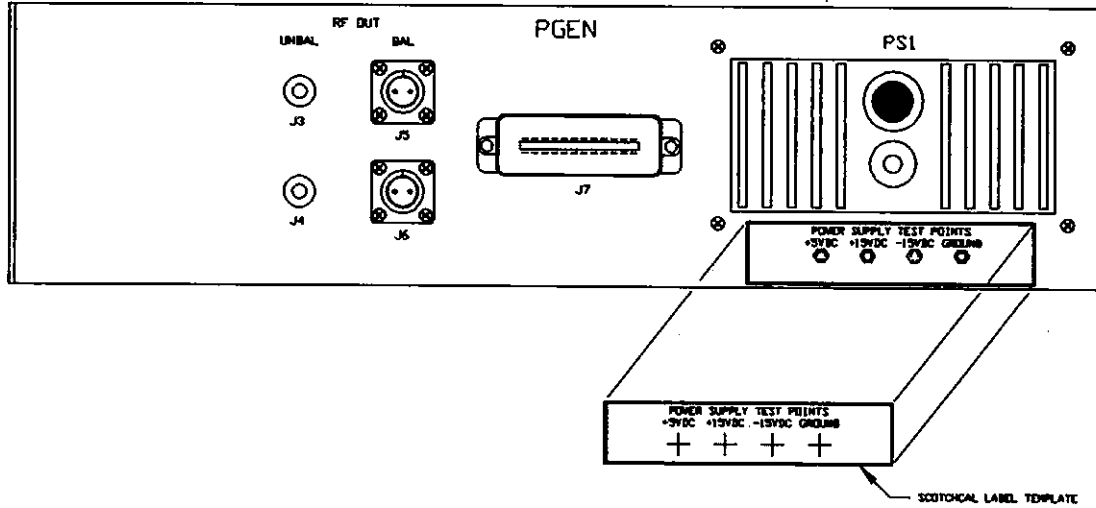


TABLE 1

PGEN POWER SUPPLY WIRE HOOK-UP CONNECTION POINT(S) FOR TEST JACKS			
POWER SUPPLY AND VOLTAGES	CONNECTOR < XPSI >	TEST JACK DESTINATION	
PSI	+5VDC	PIN 12	TP1 RED
	+15VDC	PIN 2	TP2 BROWN
	-15VDC	PIN 3	TP3 BLUE
	GROUND	PIN 1	TP4 GREEN

TABLE 2

	NOMINAL VOLTAGE	UPPER LIMIT	LOWER LIMIT	AC RIPPLE
PSI	+5.0V	+5.25V	+4.75V	1.4mV
	+15.0V	+15.5V	+14.5V	2.8mV
	-15.0V	-15.5V	-14.5V	2.8mV

Figure 3

NOTE:

Safety goggles should be worn while performing steps 3.10-3.12

- 3.10 Using a center punch and hammer, mark a hole on the large plus signs (+) of the test point label.
- 3.11 Using an electric drill with an 1/4-inch twist drill, drill holes through the chassis on the punches made in step 3.10, taking care not to damage parts inside the chassis.
- 3.12 Remove the burrs from the holes using a small metal file and remove any metal shaving from the inside chassis using a vacuum cleaner.
- 3.13 Use table 1 of Figure 3 for correct tip jack color location. Mount the tip jacks to the rear panel of the PGEN using its associated star washer and bolt.
- 3.14 Strip, fasten and solder the Red wire, parts kit item #28, to the Red tip jack, parts kit item #32.
- 3.15 Cut and place a 1/2-inch section of electrical insulating sleeving, parts kit item #36, over the soldered connection, ensure solder connection is completely covered. Use a heat gun to reduce the diameter of the electrical insulating sleeve.
- 3.16 Repeat steps 3.14 and 3.15 for all three colored tip jacks; using the chart below:

TEST POINT#	TIP JACK COLOR	WIRE COLOR
TP2	Brown	Brown
TP3	Blue	Blue
TP4	Green	Green

- 3.17 On the edge connector XPS1, remove the heat shrink from pins 1, 2, 3, and 12.
- 3.18 Form and route the Red, Brown, Green, and Blue wires along existing power supply edge connector wiring harness. Using tiedown straps, parts kit item #38, loosely tie the wires to maintain the route.
- 3.19 Connect tip jacks to XPS1:
- De-solder existing wiring on XPS1 pin 1.
 - Locate the Green wire from TP4, trim, strip and twist together with the wire removed from pin 1.
 - Place a 1/2-inch length of electrical insulating sleeve, parts kit item #36, over the new pin 1 wire bundle.
 - Reconnect and solder the wires back to pin 1.
 - Place the electrical insulating sleeve over the soldered connection and use a heat gun to reduce the diameter of the electrical insulating sleeve.

ENCLOSURE (1)

3.20 Repeat step 19 for the following tip jacks:

<u>XPS1 CONNECTION</u>	<u>WIRE COLOR</u>	<u>TEST POINT#</u>
Pin 2	Brown	TP2
Pin 3	Blue	TP3
Pin 12	Red	TP1

3.21 Properly dress the wires to the power supply edge connector wiring harness tightening all tiedown straps.

3.22 Perform a continuity test by using an ohmmeter to measure between the test point jacks and power supply edge connector pins. Refer to Table 1 of Figure 3.

3.23 Attach XPS1, edge connector, to the power supply and reinstall the power supply and PCBs removed in steps 3.7 and 3.8.

3.24 Apply AC power to PGEN on the work bench. Using a multimeter verify the correct voltages correspond to each test point as indicated in Table 2 of Figure 3. Refer to the AN/FPN-60(V) Series Transmitter Control Set Technical Manual for power supply adjustments.

3.25 Remove AC power from the PGEN, replace the top cover tightening the captive hardware fasteners, install the PGEN into the Transmitter Control Set. Reinstall the rack mounting screws.

3.26 Reconnect all cables disconnected in step 3.4.

3.27 Reconnect AC power. Using both a digital multimeter and Oscilloscope check the power supply voltages and ripple. Refer to Table 2 of Figure 3 for proper voltage levels.

3.28 Verify all switches and connections are in their proper position and all proper indications are displayed.

3.29 Return equipment to normal configuration:

- a. Place timers in remote control.
- b. Place transmitter in remote control.
- c. Place LSOS in normal operating mode.
- d. Advise the Control Monitor Station that you have completed maintenance on the PGEN and the timers are in remote control and the Local Site Operating System (LSOS) is in normal operating mode.

PARTS LIST FOR FIELD CHANGE #9 PARTS KIT A
NSN CG 5825-01-GL7-5697

Parts for installing field change in the TS-3550/FPN Electrical Pulse Analyzer

<u>Item</u>	<u>Quantity</u>	<u>Description</u>	<u>National Stock Number</u>
1	1	Wire, 35", AWG 22, Red	6145-00-548-2692
2	1	Wire, 35", AWG 22, Brown	6145-00-643-3714
3	1	Wire, 35", AWG 22, Blue	6145-00-643-2178
4	1	Wire, 35", AWG 22, Orange	6145-00-669-6622
5	1	Wire, 35", AWG 22, Green	6145-00-617-0372
6	1	Tip Jack, Red (Test Point)	5935-00-702-4199
7	1	Tip Jack, Brown (Test Point)	5935-00-764-2135
8	1	Tip Jack, Blue (Test Point)	5935-00-766-4617
9	1	Tip Jack, Orange (Test Point)	5935-00-813-5874
10	1	Tip Jack, Green (Test Point)	5935-00-733-6587
11	1	Insulating sleeving, Electrical 4.0" length	5970-00-954-1622
12	2	Test point label	
13	15	Strap, Tiedown, 4 inch	5975-00-111-3208
14	8	Terminal lug, 16-22 AWG, #6 Stud Size	5940-00-231-4430

Parts for installing field change in the C-9888/FPN-60(V) Transmitter Coupler Control

<u>Item</u>	<u>Quantity</u>	<u>Description</u>	<u>National Stock Number</u>
15	1	Wire, 22", AWG 22, Red	6145-00-548-2692
16	1	Wire, 22", AWG 22, Brown	6145-00-643-3714
17	1	Wire, 22", AWG 22, Blue	6145-00-643-2178
18	1	Wire, 35", AWG 22, Orange	6145-00-669-6622
19	1	Wire, 22", AWG 22, Green	6145-00-617-0372
20	1	Tip Jack, Red (Test Point)	5935-00-702-4199
21	1	Tip Jack, Brown (Test Point)	5935-00-764-2135
22	1	Tip Jack, Blue (Test Point)	5935-00-766-4617
23	1	Tip Jack, Orange (Test Point)	5935-00-813-5874
24	1	Tip Jack, Green (Test Point)	5935-00-733-6587
25	1	Insulating sleeving, Electrical 4.0" length	5970-00-954-1622
26	2	Test point label	
27	15	Strap, Tiedown, 4 inch	5975-00-727-5153

ENCLOSURE (2)

PARTS LIST FOR FIELD CHANGE #9 PARTS KIT A
NSN CG 5825-01-GL7-5697

Parts for installing field change in the SG-1099/FPN-60(V) Pulse Generator

NOTE:

Single-rated stations will require two-part packages, one for each SG-1099/FPN-60(V) Pulse Generator.

<u>Item</u>	<u>Quantity</u>	<u>Description</u>	<u>National Stock Number</u>
28	1	Wire, 22", AWG 22, Red	6145-00-548-2692
29	1	Wire, 22", AWG 22, Brown	6145-00-643-3714
30	1	Wire, 22", AWG 22, Blue	6145-00-643-2178
31	1	Wire, 22", AWG 22, Green	6145-00-617-0372
32	1	Tip Jack, Red (Test Point)	5935-00-702-4199
33	1	Tip Jack, Brown (Test Point)	5935-00-764-2135
34	1	Tip Jack, Blue (Test Point)	5935-00-766-4617
35	1	Tip Jack, Green (Test Point)	5935-00-733-6587
36	1	Insulating sleeving, Electrical 4.0" length	5970-00-954-1622
37	2	Test point label	
38	15	Strap, Tiedown, 4 inch	5975-00-727-5153

PARTS LIST FOR FIELD CHANGE #9 PARTS KIT B
NSN CG 5825-01-GL7-5698

Parts for installing field change in the TS-3550/FPN Electrical Pulse Analyzer

<u>Item</u>	<u>Quantity</u>	<u>Description</u>	<u>National Stock Number</u>
1	1	Wire, 35", AWG 22, Red	6145-00-548-2692
2	1	Wire, 35", AWG 22, Brown	6145-00-643-3714
3	1	Wire, 35", AWG 22, Blue	6145-00-643-2178
4	1	Wire, 35", AWG 22, Orange	6145-00-669-6622
5	1	Wire, 35", AWG 22, Green	6145-00-617-0372
6	1	Tip Jack, Red (Test Point)	5935-00-702-4199
7	1	Tip Jack, Brown (Test Point)	5935-00-764-2135
8	1	Tip Jack, Blue (Test Point)	5935-00-766-4617
9	1	Tip Jack, Orange (Test Point)	5935-00-813-5874
10	1	Tip Jack, Green (Test Point)	5935-00-733-6587
11	1	Insulating sleeving, Electrical 4.0" length	5970-00-954-1622
12	2	Test point label	
13	15	Strap, Tiedown, 4 inch	5975-00-111-3208
14	8	Terminal lug, 16-22 AWG, #6 Stud Size	5940-00-231-4430

Parts for installing field change in the C-9888/FPN-60(V) Transmitter Coupler Control

<u>Item</u>	<u>Quantity</u>	<u>Description</u>	<u>National Stock Number</u>
15	1	Wire, 22", AWG 22, Red	6145-00-548-2692
16	1	Wire, 22", AWG 22, Brown	6145-00-643-3714
17	1	Wire, 22", AWG 22, Blue	6145-00-643-2178
18	1	Wire, 35", AWG 22, Orange	6145-00-669-6622
19	1	Wire, 22", AWG 22, Green	6145-00-617-0372
20	1	Tip Jack, Red (Test Point)	5935-00-702-4199
21	1	Tip Jack, Brown (Test Point)	5935-00-764-2135
22	1	Tip Jack, Blue (Test Point)	5935-00-766-4617
23	1	Tip Jack, Orange (Test Point)	5935-00-813-5874
24	1	Tip Jack, Green (Test Point)	5935-00-733-6587
25	1	Insulating sleeving, Electrical 4.0" length	5970-00-954-1622
26	2	Test point label	
27	15	Strap, Tiedown, 4 inch	5975-00-727-5153

ENCLOSURE (3)

PARTS LIST FOR FIELD CHANGE #9 PARTS KIT B
NSN CG 5825-01-GL7-5698

Parts for installing field change in the SG-1099/FPN-60(V) Pulse Generator

NOTE:

Dual Rated stations will require four part packages, one for each SG-1099/FPN-60(V) Pulse Generator.

<u>Item</u>	<u>Quantity</u>	<u>Description</u>	<u>National Stock Number</u>
28	1	Wire, 22", AWG 22, Red	6145-00-548-2692
29	1	Wire, 22", AWG 22, Brown	6145-00-643-3714
30	1	Wire, 22", AWG 22, Blue	6145-00-643-2178
31	1	Wire, 22", AWG 22, Green	6145-00-617-0372
32	1	Tip Jack, Red (Test Point)	5935-00-702-4199
33	1	Tip Jack, Brown (Test Point)	5935-00-764-2135
34	1	Tip Jack, Blue (Test Point)	5935-00-766-4617
35	1	Tip Jack, Green (Test Point)	5935-00-733-6587
36	1	Insulating sleeving, Electrical 4.0" length	5970-00-954-1622
37	2	Test point label	
38	15	Strap, Tiedown, 4 inch	5975-00-727-5153

TECHNICAL MANUAL CORRECTIONS FOR THE AN/FPN-60(V)
TRANSMITTER CONTROL SET TECHNICAL MANUAL

1. Remove and insert the following pages:

<u>Remove</u>	<u>Insert</u>
a. v / vi	v / vi (FC-9)
b. vii/viii	vii (FC-9) / viii (FC-9)
c. 1.1/1.2 (FC-5)	1.1 (FC-9) / 1.2 (FC-9)
d. 1.3 (FC-5) / 1.4	1.3 (FC-9) / 1.4 (FC-9)
e. 1.7 (FC-5) / 1.8 (FC-5)	1.7 (FC-9) / 1.8 (FC-9)
f. 1.9 (FC-5) / 1.10	1.9 (FC-9) / 1.10 (FC-9)
g. 2.35 / 2.36	2.35 (FC-9) / 2.36 (FC-9)
h. 5.25 / 5.26	5.25 (FC-9) / 5.26 (FC-9)
i. None	5.26A (FC-9) / 5.26B (FC-9)
j. 5.31 / 5.32	5.31 / 5.32 (FC-9)
k. None	5.32A (FC-9) / 5.32B (FC-9)
l. 7.1 / 7.2	7.1 (FC-9) / 7.2 (FC-9)
m. 7.31 / 7.32	7.31 (FC-9) / 7.32 (FC-9)
n. 7.43 / 7.44	7.43 (FC-9) / 7.44 (FC-9)
o. 7.63 / 7.64	7.63 (FC-9) / 7.64 (FC-9)
p. 7.79 (FC-5) / 7.80 (FC-5)	7.79 (FC-9) / 7.80 (FC-9)
q. B.1 (FC-5) / B.2 (FC-5)	B.1 (FC-9) / B.2 (FC-9)

2. Remove the AN/FPN-60(V) Technical Manual title page and replace with the AN/FPN-60(V) and AN/FPN-60A(V) Series Technical Manual title page.

3. Remove the AN/FPN-60(V) spine insert and replace with the AN/FPN-60(V) and AN/FPN-60A(V) Series spine insert.

4. Remove the AN/FPN-60(V) Technical Manual cover sheet and replace with the AN/FPN-60(V) and AN/FPN-60A(V) Series cover sheet.



...





ELECTRONIC FIELD CHANGE BULLETIN

F.C. NO. 8 TYPE 4 TO AN/FPN-60(V) TRANSMITTER CONTROL SET

AUG 13 1993

PURPOSE:

The purpose of this field change is to re-issue documentation for Field Change No. 1 Type 4 to AN/FPN-60 Transmitter Control Set of 22 August 1977.

DESCRIPTION:

1. The field change consists of checking for proper installation of power cube PS2 in the TS-3550/FPN Electrical Pulse Analyzer (EPA).
2. It also provides a page addition to the AN/FPN-60(V) Series Transmitter Control Set Technical Manual.

EQUIPMENT AFFECTED:

This field change is applicable to Loran-C stations operating with AN/FPN-60(V) Series Transmitter Control Set equipment.

IDENTIFICATION OF ACCOMPLISHMENT:

This field change may be identified by the 5-VDC Datel power cube PS2 mounted, bottom up, and heat sunk to the EPA chassis.

MATERIALS REQUIRED:

1. A Field Change No. 8 Bulletin and enclosures (1) through (3) are required to complete this Field Change.

DISTRIBUTION - SDL No. 130

	a	b	c	d	e	f	g	h	i	j	k	l	m	n	o	p	q	r	s	t	u	v	w	x	y	z
A																										
B	*	*	*		2				*								2	10	10							
C											*											*				
D	*																									
E								1																		
F																										
G																										
H																										

NON-STANDARD DISTRIBUTION: Ba: COMDI[G-TES (1); G-TES-3, G-TES-3/CGPMS, G-TES-4, G-NRN (2)]

Bb: LANTAREA(At1), PACAREA(Pt1) (2)

Bc: MLCLANT(tst), MLCPAC(tes) (2)

Bi: SUPCEN Brooklyn (2)

Ck: Kodiak (2)

Cv: LORSTAs(Angissoq, Attu, Barrigada, Bo, Cape Race, Dana, Ejde, Estartit, Fallon, George, Gesashi, Hokkaido, Iwo Jima, Jan Maven, Karcaburun, Kodiak, Lampedusa, Marcus Island, Middletown, Port Clarence, Sandur, SearchLight, Sellia Marina, Shoal Cove, St. Paul Island, Sylt, Tok, and Williams Lake) (2)

Da: Tokyo, Guam (2)

Non-Standard Distribution (Continued on page 2)

PROCEDURE:

1. Follow all safety instructions outlined in COMDTINST M10550.25 Chapter 2.
2. Follow the step-by-step installation instructions of enclosure (1).

ROUTINE INSTRUCTIONS:

1. Record completion of all changes by an entry on the Field Change Accomplished Plate, NSN 0264-LP-085-0000 (available from the Naval Publications and Forms Center, Philadelphia, PA).
2. Maintenance support facilities shall maintain a library copy of this and all other applicable field change bulletins. Additional and replacement copies can be obtained from Coast Guard Supply Center, Brooklyn, NY (Code 341). Order directly, using MILSTRIP procedures; no cost is involved. NSN CG 7610-01-GE8-1757 applies.
3. Upon completion, a copy of this Field Change Bulletin shall be inserted in the front of all applicable technical manuals. Cognizant commands shall ensure that the Field Change has been accomplished, and that applicable reports have been made.


L. T. ANDERSON

- Encl: (1) Step-by-step Installation Instructions
(2) Parts List for Field Change No. 8
(3) Technical Manual Corrections to the AN/FPN-60(V)
Series Transmitter Control Technical Manual

Non-Standard Distribution (Continued from page 1)

COCO GOA/NORPAC
C/O CG SUPPORT CENTER
P. O. BOX 190032
KODIAK, AK 99619-0032 (2 COPIES)

COCO
C/O USCG LORAN-C STATION
BOX 28
ROMULUS, NY 14541-0028 (2 COPIES)

COCO NWPAC/EALC
USCG FAR EAST SECTION
UNIT 5073
APO AP 96328-5073 (2 COPIES)

TRANSPORT CANADA
COAST GUARD TELCOM
ELECTRONICS DIRECTORATE
THE CANADA BUILDING
344 SLATER STREET
OTTAWA, ONTARIO K1A0N7
ATTN: AMTJ-E (2 COPIES)

COCO
C/O USCG LORAN-C STATION
P. O. BOX 387
MALONE, PL 32445-0387 (2 COPIES)

COCO (7990)
C/O USCG LORAN-C STATION
PMC ROME DET PSC 827M, BOX 90
FPO AE 09625-6002 (2 COPIES)

COCO USWC/NOCUS
C/O USCG LORAN-C STATION
MIDDLETOWN, CA 95461-9999(2 COPIES)

COORDINATOR OF CHAIN OPERATIONS
CANADIAN COAST GUARD - T&E
411 - 100 PARK ROYAL SOUTH
W. VANCOUVER, BC, CANADA V7T 1A2 (2 COPIES)

CANADIAN COAST GUARD
BOX 693
ST. ANTHONY, NF AOK 4S0 (2 COPIES)

STEP-BY-STEP INSTALLATION INSTRUCTIONS

1. Inform control site before starting this procedure.
2. Secure 115-VAC power to the TS-3550/FPN Envelope Pulse Analyzer (EPA).
3. Tag and disconnect cables from back of EPA. Connect the cable removed from jack J7 into cabinet dummy load.
4. Remove EPA from Loran Replacement Equipment (LRE) rack.
5. Remove the top cover of the EPA.
6. Locate the 5-VDC Datel power cube PS2 to see if it is mounted with silicon heat-sink compound to the EPA chassis, and held in place by four, 1 1/4-inch spacers. See Figure 7.20A, enclosure (3).
7. If power cube PS2 is correctly installed on the EPA chassis, skip Steps 8 through 12 and continue with Step 13.
8. If power cube PS2 is not installed properly on the EPA chassis and is still suspended above the chassis by four, 1-inch spacers, proceed with Steps 9 through 17.
9. Remove the four 6-32 panhead, crosspoint screws which mount the power cube PS2 to the EPA chassis.
10. Remove the four, 1-inch threaded spacers on which the power cube PS2 is mounted, and insert four, 1 1/4-inch threaded spacers.
11. Apply a thin coat of silicone insulating compound to the top of the power cube PS2.
12. Heat sink the power cube PS2 to the EPA chassis by turning the power cube PS2 upside down, bottom up. Secure the power cube PS2 to the EPA with the four, 6-32 screws removed in Step 9. (See Figure 1.)
13. Replace the top cover on the EPA.
14. Install the EPA into the LRE rack.
15. Reconnect all cables that were disconnected in Step 3.
16. Reconnect 115-VAC power to the EPA and observe readings. EPA should operate normally.
17. Inform the control site when equipment is returned to normal operation.



PARTS LIST FOR FIELD CHANGE #8

<u>ITEM</u>	<u>QTY</u>	<u>DESCRIPTION</u>	<u>SOURCE</u>
1	4	1.250 inch threaded metal spacer	P/N 313 6477 028 E.F. Johnson Co. P.O. Box Drawer 59089 Minneapolis, MN 55459 1-800-747-8167
2	1	Silicone insulating compound	NSN 9G 6850-00-927-9461



TECHNICAL MANUAL CORRECTIONS TO THE AN/FPN-60(V) SERIES
TRANSMITTER CONTROL SET

1. This enclosure provides changes to the AN/FPN-60(V) Series Transmitter Control Set. It documents the proper installation of power cube PS2 in the TS-3550/FPN.
2. Insert page 7.42A/7.42B before page 7.43 in Section 7 of the technical manual.





ELECTRONIC FIELD CHANGE BULLETIN

F.C. NO. 7 TYPE 1 TO AN/FPN-60(V) TRANSMITTER CONTROL SET

PURPOSE:

The purpose of this field change is to install new nomenclature plates which properly identify units of the AN/FPN-60 (V) Loran-C Transmitter Control Set.

DESCRIPTION:

This field change consists of replacing the nomenclature plates on the GCF-W-757-TSS, C-9888/FPN-60, TS-3550/FPN-60, SG-1099/FPN-60, and CY-7523/FPN-60 with new nomenclature plates.

EQUIPMENT AFFECTED:

This field change is applicable to all Loran-C stations that have the AN/FPN-60(V) Transmitter Control Set installed.

IDENTIFICATION OF ACCOMPLISHMENT:

The presence of the following nomenclature plates will identify this change: SM-807/FPN-60(V), C-9888/FPN-60(V), TS-3550/FPN, SG-1099/FPN-60(V), and CY-7523/FPN-60(V).

MATERIALS REQUIRED:

1. A Field Change Bulletin No. 7, with enclosure (1), new nomenclature plates, and standard hand tools are all that is required to perform this Field Change.
2. For field change materials at no cost, field units and commanding officers of Headquarters units will send "APA MILSTRIP REQUISITIONS" to Supply Center, Brooklyn, in accordance with current directives. National Stock Numbers (NSNs) for nomenclature plates are provided in enclosure (2).

DISTRIBUTION - SDL No. 130

	a	b	c	d	e	f	g	h	i	j	k	l	m	n	o	p	q	r	s	t	u	v	w	x	y	z
A																										
B	*	*	*		2				*								2	10	10							
C											*											*				
D	*																									
E								1																		
F																										
G																										
H																										

NON-STANDARD DISTRIBUTION: Ba: COMDT[G-TES (1); G-TES-3, G-TES-3/CCPMS, G-TES-4, G-NRN only (2)]
 Bb: LANTAREA(At1) and PACAREA(Pt1) (2)
 Bc: MLCLANT(tst) and MLCPAC(tes) (2)
 Bi: SUPCEN Brooklyn (2)
 Ck: SUPRCEN Kodiak only (2)
 Cv: LORSTAs(Angissoq, Attu, Barrigada, Boe, Cape Race, Dana, Ejde, Estartit, Fallon, George, Gesashi, Hokkaido, Iwo Jima, Jan Mayen, Kargabarun, Lampedusa, Marcus, Middletown, Kodiak, Sylt, Port Clarence, Sandur, Searchlight, Sellia Marina, Shoal Cove, St. Paul, Williams Lake, & Tok) (2)
 Da: Tokyo and Guam (2)

PROCEDURE:

1. Follow all safety instructions outlined in COMDTINST M10550.25 Chapter 2.
2. Follow step-by-step instructions of enclosure (1).

ROUTINE INSTRUCTIONS:

1. Record completion of this Field Change by an entry on the Field Change Accomplished Plate, NSN 0264-LP-085-0000 (available from the Naval Publications and Forms Center, Philadelphia, PA).
2. Maintenance support facilities shall maintain a library copy of this and all other applicable field change bulletins. Additional and replacement copies can be obtained from Coast Guard Supply Center, Brooklyn, NY (Code 341). Order directly, using MILSTRIP procedures; no cost is involved. NSN CG 7610-01-GE8-1756 applies.
3. Upon completion, a copy of this Field Change Bulletin shall be inserted in the front of all applicable technical manuals. Cognizant commands shall ensure that the field change has been accomplished, and that applicable reports have been made.


L. T. ANDERSON

- Encl: (1) Step-by-step Installation Instructions
(2) Nomenclature Plate NSN List For Field Change No. 7

Non-Standard Distribution (Continued from page 1)

COCO GOA/NORPAC
C/O CG SUPPORT CENTER
P. O. BOX 190032
KODIAK, AK 99619-0032 (2 COPIES)

COCO
C/O USCG LORAN-C STATION
BOX 28
ROMULUS, NY 14541-0028 (2 COPIES)

COCO NWPAC/EALC
USCG FAR EAST SECTION
UNIT 5073
APO AP 96328-5073 (2 COPIES)

COORDINATOR OF CHAIN OPERATIONS
CANADIAN COAST GUARD - T&E
411 - 100 PARK ROYAL SOUTH
W. VANCOUVER, BC, CANADA V7T 1A2 (2 COPIES)

COCO
C/O USCG LORAN-C STATION
P. O. BOX 387
MALONE, FL 32445-0387 (2 COPIES)

COCO (7990)
C/O USCG LORAN-C STATION
FMC ROME DET PSC 827M, BOX 90
FPO AE 09625-6002 (2 COPIES)

COCO USWC/NOCUS
C/O USCG LORAN-C STATION
MIDDLETOWN, CA 95461-9999 (2 COPIES)

LORMONSTA
CANADIAN COAST GUARD
BOX 693
ST. ANTHONY, NF AOK 4S0 (1 COPY)

CANADIAN COAST GUARD (AMTJ-E)
THE CANADA BUILDING, 5TH FLOOR
344 SLATER STREET
OTTAWA, ONTARIO, CANADA K1A 0N7 (2 COPIES)

STEP-BY-STEP INSTALLATION INSTRUCTIONS

1. Remove the nomenclature plate GCF-W-757-TSS from the Transmitter System Simulator.
2. Stamp or inscribe the serial number that is on the GCF-W-757-TSS nomenclature plate onto the SM-807/FPN-60(V) nomenclature plate.
3. Install the nomenclature plate SM-807/FPN-60(V) using the existing hardware.
4. Remove the nomenclature plate C-9888/FPN-60 from the Coupler Transmitter Control.
5. Stamp or inscribe the serial number that is on the C-9888/FPN-60 nomenclature plate onto the C-9888/FPN-60(V) nomenclature plate.
6. Install the nomenclature plate C-9888/FPN-60(V) using the existing hardware.
8. Remove the nomenclature plate TS-3550/FPN-60 from the Electrical Pulse Analyzer.
9. Stamp or inscribe the serial number that is on the TS-3550/FPN-60 nomenclature plate onto the TS-3550/FPN nomenclature plate.
10. Install the nomenclature plate TS-3550/FPN using the existing hardware.
11. Remove the nomenclature plate SG-1099/FPN-60 from the Pulse Generator.
12. Stamp or inscribe the serial number that is on the SG-1099/FPN-60 nomenclature plate onto the SG-1099/FPN-60(V) nomenclature plate.
13. Install the nomenclature plate SG-1099/FPN-60(V) using the existing hardware.
14. Remove the nomenclature plate CY-7523/FPN-60 from the Electrical Equipment Cabinet.
15. Stamp or inscribe the serial number that is on the CY-7523/FPN-60 nomenclature plate onto the CY-7523/FPN-60(V) nomenclature plate.
16. Install the nomenclature plate CY-7523/FPN-60(V) using the existing hardware.

ENCLOSURE (1)

17. Remove the GCF-W-757-TSS, C-9888/FPN-60, TS-3550/FPN-60, SG-1099/FPN-60, and CY-7523/FPN-60 from the Electronic Installation Record (EIR) using the Electronic Equipment Information System (EEIS) procedures stating, "NOMENCLATURE CHANGE" in the comments field. Note that these old nomenclatures may no longer appear in the EEIS Master Equipment Nomenclature file. In such a case, red-line the item on the EIR, and add the comment "NOMENCLATURE CHANGE" in the margin.

18. Enter the SM-807/FPN-60(V), C-9888/FPN-60(V), TS-3550/FPN, SG-1099/FPN-60(V), and CY-7523/FPN-60(V) as a new installation using EEIS procedures.

NOMENCLATURE PLATE NATIONAL STOCK NUMBER
LIST FOR FIELD CHANGE NO. 7

<u>ITEM</u>	<u>DESCRIPTION</u>	<u>NSN</u>
1	SM-807/FPN-60(V) Nomenclature Plate	CG 9905-01-GL7-5103
2	C-9888/FPN-60(V) Nomenclature Plate	CG 9905-01-GL7-5104
3	TS-3550/FPN Nomenclature Plate	CG 9905-01-GL7-5105
4	SG-1099/FPN-60(V) Nomenclature Plate	CG 9905-01-GL7-5106
5	CY-7523/FPN-60(V) Nomenclature Plate	CG 9905-01-GL7-5107





05 APR 1985

ELECTRONIC FIELD CHANGE BULLETIN

F.C. NO. 5 TYPE 1 TO AN/FPN-60 TRANSMITTER CONTROL SET

PURPOSE:

This field change modifies the AN/FPN-60 Transmitter Control Set (TCS) Technical Manual to reflect the Remote Operating System (ROS) equipment modifications. It also replaces old nomenclature plates with new nomenclature plates to reflect whether the equipment is non-ROS- or ROS-modified.

DESCRIPTION:

1. This field change incorporates a new appendix, new parts list pages, and new schematic pages into the AN/FPN-60 Transmitter Control Set (TCS) Technical Manual to reflect the Remote Operating System (ROS) equipment modifications.
2. This field change replaces the nomenclature plates in the AN/FPN-60 TCS with new nomenclature plates.

<u>Original</u>	<u>Non-ROS-Modified</u>	<u>ROS-Modified</u>
AN/FPN-60	AN/FPN-60(V)	AN/FPN-60A(V)
J-3353/FPN-60	J-3353/FPN-60(V)	J-3353/FPN-60A(V)
SA-2063/FPN-60	SA-2063/FPN-60(V)	SA-2063/FPN-60A(V)

3. This field change modifies the TS-3550/FPN Electrical Pulse Analyzer (EPA) to allow the watchstander and maintenance technician to view peak volts and Envelope-to-Cycle Difference (ECD) on the TS-3550/FPN EPA's Digital Panel Meter when the TS-3550/FPN is in the "Remote" mode.

DISTRIBUTION - SDL No. 132

	a	b	c	d	e	f	g	h	i	j	k	l	m	n	o	p	q	r	s	t	u	v	w	x	y	z
A																										
B	*	*	*		2				*									10	5							
C																							*			
D																										
E								*													1					
F																										
G																										
H																										

NON-STANDARD DISTRIBUTION: Ba: COMDT(G-NRN, G-TES, G-TES-2, G-TES-3, G-TES-3/CGPMS, G-TES-4) (1)
 Bb: LANIAREA(At1) and PACAREA(Pt1) (2)
 Bc: MLCLANT(tst) and MLCAPAC(tes) (2)
 Bi: SUPCEN Baltimore (2)
 Cv: LORSTAS(Attu, Dana, Fallon, George, Middletown, Kodiak, Port Clarence, Searchlight, Shoal Cove, St. Paul, and Tok) (2)
 Eh: EMDs(Boston, Portsmouth, Miami, Cleveland, New Orleans, and St. Louis) (1)

EQUIPMENT AFFECTED:

This field change is applicable to all AN/FPN-60 Transmitter Control Sets.

IDENTIFICATION OF ACCOMPLISHMENT:

The ability to read peak volts and ECD on the EPA Digital Panel Meter while in the "Remote" mode, and the presence of the new nomenclature plates installed on the TCS will identify this change.

MATERIALS REQUIRED:

1. Units with the AN/FPN-60(V) (non-ROS-modified) Transmitter Control Set will require Field Change No. 5 Parts Kit A, National Stock Number (NSN) CG 5825-01-GL7-5133.
2. Units with the AN/FPN-60A(V) (ROS-modified) Transmitter Control Set will require Field Change No. 5 Parts Kit B, NSN CG 5825-01-GL7-5134.
3. A Field Change No. 5 Parts Kit A or B and standard hand tools are all that is needed to perform this field change.
4. A list of parts contained in parts kit A or B is provided as enclosure (2) to this bulletin.
5. To order field change kits at no cost, field units and commanding officers of Headquarters units will send "MILSTRIP REQUISITIONS" to Supply Center Baltimore, in accordance with current directives. NSN CG 5825-01-GL7-5133 applies for Parts Kit A, and NSN CG 5825-01-GL7-5134 applies for Parts Kit B.

PROCEDURE:

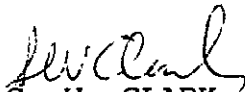
1. Follow the Step-by-step Installation Instructions provided as enclosure (1) to this bulletin for the AN/FPN-60 Nomenclature plates and TS-3550/FPN EPA modifications.
2. Follow the Technical Manual Correction Instructions provided as enclosure (3) to this bulletin to update the AN/FPN-60 Transmitter Control Set Technical Manual.

ROUTINE INSTRUCTIONS:

1. Record completion by an entry on the Field Change Accomplished Plate, NSN I 0264-LP-085-0000 (available from the Naval Publications and Forms Center, Philadelphia, PA.)

2. Maintenance support facilities shall maintain a library copy of this and all other applicable field change bulletins. Additional and replacement copies can be obtained from Coast Guard Supply Center, Baltimore, MD (Code 341). Order directly, using MILSTRIP procedures; no cost is involved. NSN CG 7610-01-GE8-1754 applies.

3. Upon completion, a copy of this field change bulletin shall be inserted in the front of all applicable technical manuals. Cognizant commands shall ensure that the field change has been accomplished, and that applicable technical manual annotations and reports have been made.


S. W. CLARK

- Encl: (1) Step-by-step Installation Instructions
(2) Parts Lists for Field Change No. 5 Parts Kits A and B
(3) Technical Manual Corrections to the AN/FPN-60 Series

Non-Standard Distribution (Continued from page 1)

Coordinator of Chain Operations
c/o USCG Support Center
P.O. Box 32
Kodiak, AK 99619-5000 (2 Copies)

Coordinator of Chain Operations
USCG Loran C Station
P.O. Box 387
Malone, FL 32445-0387 (2 Copies)

Coordinator of Chain Operations
USCG Loran C Station
Box 28
Romulus, NY 14541-0028 (2 Copies)

Coordinator of Chain Operations
USCG Loran C Station
Middletown, CA 95461-9999 (2 Copies)

Station Manager
Williams Lake Loran C Station
P.O. Box 4568
Williams Lake, British Columbia
Canada V2G 2V8 (2 Copies)

Coordinator of Chain Operations (FMYDD)
Canadian Coast Guard
P.O. Box 4670 Stn Main
Williams Lake, British Columbia
Canada V2G 2V7 (2 Copies)

Coordinator of Chain Operations
Canadian Coast Guard
Box 693
St. Anthony, Newfoundland
Canada AOK 4S0 (2 Copies)

Coast Guard Telcom
Electronics Directorate
The Canada Building
344 Slater St.
Ottawa, Ontario K1A 0N7
Attn: AMTJ-E (2 Copies)



**STEP-BY-STEP INSTALLATION INSTRUCTIONS
FOR AN/FPN-60 TRANSMITTER CONTROL SET**

NOTES:

This field change will require approximately 2 hours to install.

Observe all safety precautions outlined in COMDTINST M10550.25, Chapter 2.

Read all instructions before attempting to install this field change.

1. Inform the Control Monitor Station that you will be performing maintenance on the TS-3550/FPN Electrical Pulse Analyzer (EPA).
2. Secure power to the TS-3550/FPN EPA.
3. Label and disconnect cables from the back of the EPA, and connect the cable removed from jack J7 into the cabinet dummy load.
4. Remove the EPA from the AN/FPN-60 Transmitter Control Set (TCS).
5. Remove the top cover of the EPA.
6. Place the paper template (item #4 of F.C. No. 5 Parts Kit) over XA2 edge connector; see diagrams 1 and 2. Pin 23 and 12 should be indicated.
7. Jumper pins 23 and 12 together using the wire provided as parts kit item #5.
8. Remove the paper template. Replace the top cover on the EPA.
9. Install the EPA into the AN/FPN-60 rack.
10. Reconnect all cables that were disconnected in step 3.
11. Reconnect power to the EPA and observe readings. EPA should operate normally.
12. To verify proper installation of the jumper wire, place the Front Panel Control/Remote Control switch (S5) in the "Remote Control" position. The Digital Panel Meter should continue to display ECD and Peak Volts properly.
13. Place switch S5 back in the "Front Panel Control" position.

ENCLOSURE (1)

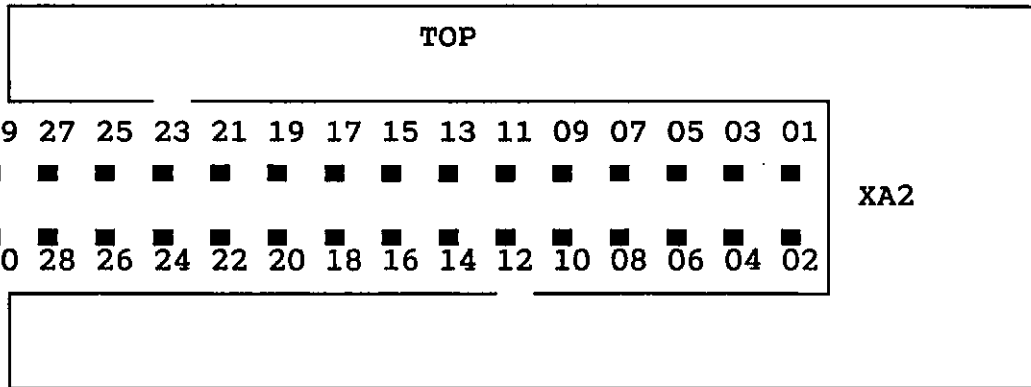


Diagram 1

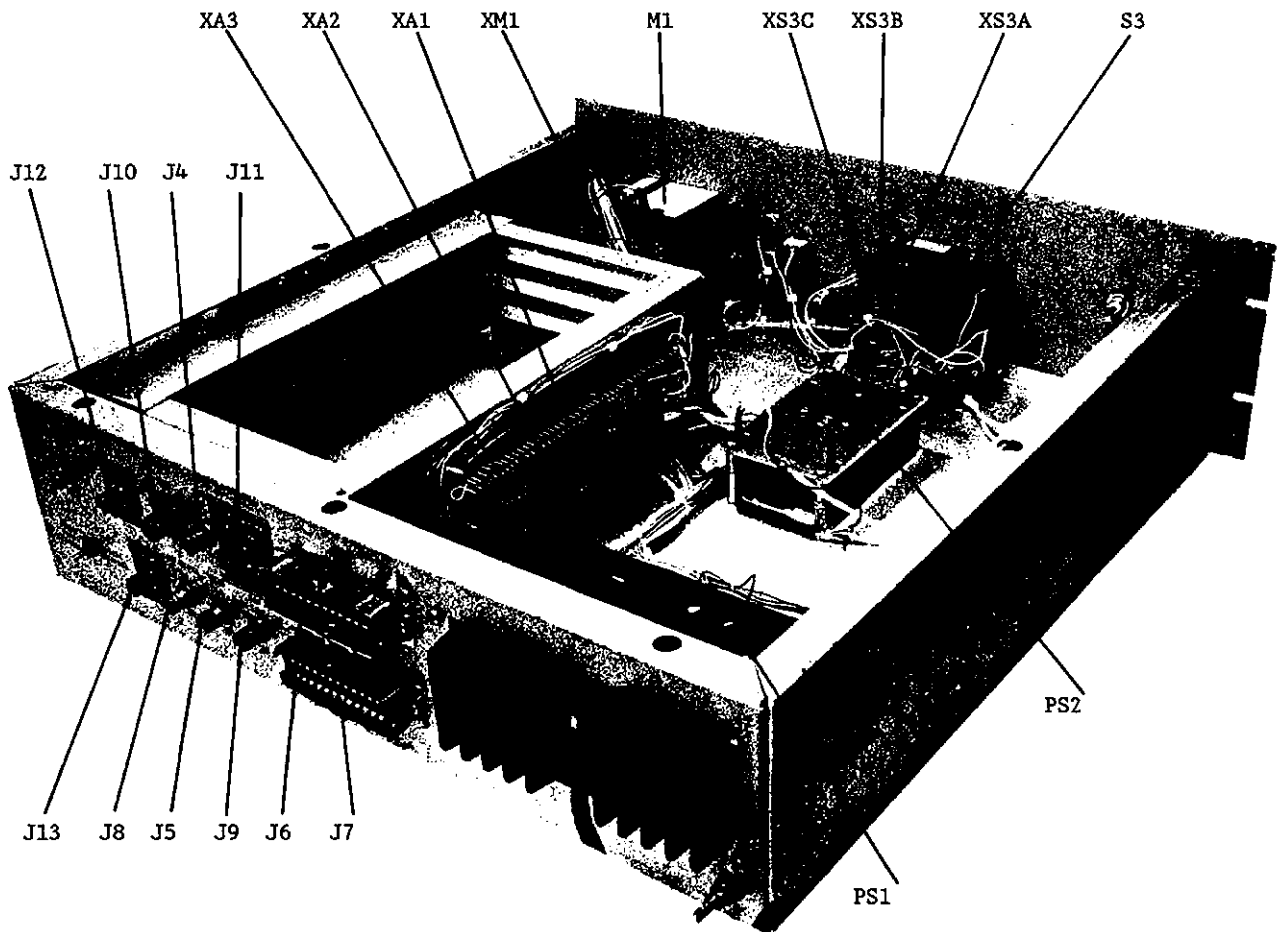


Diagram 2

14. Inform the Control Monitor Station that you have completed maintenance on the TS-3550/FPN EPA.
15. Locate the nomenclature plate AN/FPN-60 on the front of the TCS and remove it. Locate the nomenclature plate AN/FPN-60(V) or AN/FPN-60A(V), parts kit item #1. Stamp or inscribe the serial number that is on the AN/FPN-60 nomenclature plate onto the AN/FPN-60(V) or AN/FPN-60A(V) nomenclature plate. Install the new nomenclature plate using the existing hardware.
16. Locate the nomenclature plate J-3353/FPN-60 on the Interface Unit and remove it. Locate the nomenclature plate J-3353/FPN-60(V) or J-3353/FPN-60A(V), parts kit item #2. Stamp or inscribe the serial number that is on the J-3353/FPN-60 nomenclature plate onto the J-3353/FPN-60(V) or J-3353/FPN-60A(V) nomenclature plate. Install the new nomenclature plate using the existing hardware on the Interface Unit.
17. Locate the nomenclature plate SA-2063/FPN-60 on the Switch Assembly and remove it. Locate the nomenclature plate SA-2063/FPN-60(V) or SA-2063/FPN-60A(V), parts kit item #3. Stamp or inscribe the serial number that is on the SA-2063/FPN-60 nomenclature plate onto the SA-2063/FPN-60(V) or SA-2063/FPN-60A(V) nomenclature plate. Install the new nomenclature plate using the existing hardware on the Switch Assembly.
18. Deinstall the AN/FPN-60, J-3353/FPN-60, and SA-2063/FPN-60 from the Electronic Installation Record (EIR) using the Electronic Equipment Information System (EEIS) procedures, stating "NOMENCLATURE CHANGE" in the comments field.
19. Enter the AN/FPN-60(V), SA-2063/FPN-60(V), J-3353/FPN-60(V) or AN/FPN-60A(V), SA-2063/FPN-60A(V), J-3353/FPN-60A(V) as a new installation; whichever applies to your station, using EEIS procedures.



PARTS LIST FOR FIELD CHANGE #5 PARTS KIT A
NSN CG 5825-01-GL7-5133.

<u>ITEM</u>	<u>QTY</u>	<u>DESCRIPTION</u>
1	1	AN/FPN-60(V) Nomenclature Plate
2	1	J-3353/FPN-60(V) Nomenclature Plate
3	1	SA-2063/FPN-60(V) Nomenclature Plate
4	1	XA2 Paper Template
5	1	3-3/4" Jumper Wire

PARTS LIST FOR FIELD CHANGE #5 PARTS KIT B
NSN CG 5825-01-GL7-5134.

<u>ITEM</u>	<u>QTY</u>	<u>DESCRIPTION</u>
1	1	AN/FPN-60A(V) Nomenclature Plate
2	1	J-3353/FPN-60A(V) Nomenclature Plate
3	1	SA-2063/FPN-60A(V) Nomenclature Plate
4	1	XA2 Paper Template
5	1	3-3/4" Jumper Wire

ENCLOSURE (3)

c. Page 1.5, Figure 1.3: change SA-2063/FPN-60 to read "SA-2063/FPN-60(V)". Also change Figure 1.4, C-9888/FPN-60 to read "C-9888/FPN-60(V)".

d. Page 1.7, Figure 1.6: change SG-1099/FPN-60 to read "SG-1099/FPN-60(V)". Also change Figure 1.7, SB-4156/FPN-60 to read "SB-4156/FPN-60(V)".

e. Page 1.8, Figure 1.8: change J-3353/FPN-60 to read "J-3353/FPN-60(V)". Also change Table 1.1, C-9888/FPN-60 to read "C-9888/FPN-60(V)"; and change Table 1.1, SG-1099/FPN-60 to read "SG-1099/FPN-60(V)".

f. Page 1.9, Table 1.2: make the following changes:

Old		New
SA-2063/FPN-60	to read	"SA-2063/FPN-60(V)"
C-9888/FPN-60	to read	"C-9888/FPN-60(V)"
SG-1099/FPN-60	to read	"SG-1099/FPN-60(V)"
SB-4156/FPN-60	to read	"SB-4156/FPN-60(V)"
J-3353/FPN-60	to read	"J-3353/FPN-60(V)"
CY-7523/FPN-60	to read	"CY-7523/FPN-60(V)"

g. Page 6.1, Table 6.1: make the following changes:

Old		New
SA-2063/FPN-60	to read	"SA-2063/FPN-60(V)"
C-9888/FPN-60	to read	"C-9888/FPN-60(V)"
SG-1099/FPN-60	to read	"SG-1099/FPN-60(V)"
SB-4156/FPN-60	to read	"SB-4156/FPN-60(V)"
J-3353/FPN-60	to read	"J-3353/FPN-60(V)"
CY-7523/FPN-60	to read	"CY-7523/FPN-60(V)"

h. Page 6.2, Table 6.2: change CY-7523/FPN-60 to read "CY-7523/FPN-60(V)". Also change SA-2063/FPN-60 to read "SA-2063/FPN-60(V)"; and change C-9888/FPN-60 to read "C-9888/FPN-60(V)".

i. Page 6.7, Table 6.2: change J-3353/FPN-60 to read "J-3353/FPN-60(V)".

j. Page 7.3/7.4, Figure 7.1: change AN/FPN-60 to read "AN/FPN-60(V)1".

k. Page 7.43/7.44, Figure 7.21: locate XA2. Draw jumper wire from pin 12 to pin 23.



DEPARTMENT OF TRANSPORTATION
UNITED STATES COAST GUARD

MAILING ADDRESS: G-EEE-4
U.S. Coast Guard
Washington, D.C. 20593
(202) 426-1201

ERRATA SHEET

29 JAN 1981

TO

F.C. NO. 4 TYPE 1 TO AN/FPN-60 TRANSMITTER CONTROL SET

PURPOSE:

This ERRATA Sheet corrects the ROUTINE INSTRUCTIONS for reporting the completion of this field change.

PROCEDURE:

Under ROUTINE INSTRUCTIONS change para 1, 1st sentence to read, "For EICAM reporting purpose, report completion of this field change on Form CG-4334D using SG-1099/FPN-60 as Equipment Model/Type.

ROUTINE INSTRUCTIONS:

Upon completion, this errata sheet shall be attached in front of the indicated field change in the applicable technical publication.

J. I. MALONEY, CAPT. USCG
CHIEF, ELECTRONICS ENGINEERING DIVISION

DISTRIBUTION - SDL No. 112

	a	b	c	d	e	f	g	h	i	j	k	l	m	n	o	p	q	r	s	t	u	v	w	x	y	z	
A																			5								
B		5	5					5	5										2			2					
C																											
D	2																										
E			2																								
F																											
G																											
H																											

NON-STANDARD DISTRIBUTION: CG-31: Cape Race, Anigissoq, Sandur, BO, Jan Mayen, Ejde, Williams Lake (only) (2)

1954

Annual Report of the Board of Directors

1954

1954

1954

1954



DEPARTMENT OF TRANSPORTATION
 UNITED STATES COAST GUARD

MAILING ADDRESS (65-EEE-4/63)
 U.S. COAST GUARD
 WASHINGTON, D.C. 20540
 PHONE: 202/426-1193

30 APR 1979

ELECTRONIC FIELD CHANGE BULLETIN

F.C. NO. 4 TYPE 1 TO AN/FPN-60 TRANSMITTER CONTROL SET

PURPOSE:

The purpose of this change is to increase the resolution of the transmitted drive adjust potentiometer on the SG-1099/FPN-60 Pulse Generator and add a vernier dial with a locking feature.

DESCRIPTION:

The Field Change consists of removing the present gain control and replacing it with a ten-turn control and adding a concentric scale incremental dial with a locking feature.

IDENTIFICATION OF ACCOMPLISHMENT:

The presence of a vernier dial on the front panel of the pulse generator identifies this change.

MATERIALS REQUIRED:

1. A Field Change No. 4 Type 1 Parts Kit and standard hand tools are necessary to perform this Field Change.
2. A list of parts contained in the Field Change Parts Kit is attached as enclosure (2) to this bulletin.
3. The Field Change Parts Kit (CG5825-01-GL7-3106) is stocked at Coast Guard Supply Center, Brooklyn, NY. Initial distribution will be by Coast Guard Supply Center, Brooklyn, NY.

PROCEDURE:

Step-by-step installation instructions are provided as enclosure (1) to this bulletin.

DISTRIBUTION - SDL No. 109

	a	b	c	d	e	f	g	h	i	j	k	l	m	n	o	p	q	r	s	t	u	v	w	x	y	z
A																										
B		5	5				5	5								5	5		5							
C																			2			2				
D	2																									
E			2																							
F																										
G																										
H																										

NON-STANDARD DISTRIBUTION: B; (c) 1st, 2nd, 5th, 7th, 11th, 12th, 13th, 14th, 17th only (5). CG-31: Cape Race, Angissoq, Sandur, Bo, Jan Mayan, Ejde, Williams Lake only (2).

10

11

12

13

ROUTINE INSTRUCTIONS: 30 APR 1979

1. For EICAM reporting purposes, report completion of this Field Change on Form CG-4334D using AN/FPN-60 as EQUIPMENT MODEL/TYPE. The serial number shall be reported as shown on the Electronic Installation Record (EIR). Report the date of Field Change installation in blocks 3 to 3 on Form CG-4334D. Record completion by an entry on the Field Change Accomplished Plate, NSN I 0264-00-085-000, and on any other required records.

2. Maintenance support facilities shall maintain a library copy of this and all other field change bulletins applicable to them. Additional or missing copies can be obtained from Coast Guard Supply Center, Brooklyn, NY (CODE 341). Order directly using MILSTRIP procedures; no cost is involved. NSN CG7610-01-GE8-1753 applies.

3. Upon completion, a copy of this Field Change Bulletin shall be inserted in the front of all applicable Technical Manuals. Cognizant commands shall ensure that the field change has been accomplished and that Technical Manual annotations and reports have been made. Coast Guard Supply Center, Brooklyn, NY, will update the Allowance Parts List to reflect any changes.

R. E. Warakomsky

R. E. WARAKOMSKY
By direction

Encl: (1) Step-by-Step Installation Instructions
(2) Parts List for Field Change Kit



90 APR 1979

STEP-BY-STEP INSTALLATION INSTRUCTIONS

1. With an oscilloscope observe and record the amplitude of the transmitter drive waveform at J2 on the front panel of the standby PGEN.
2. Secure power to the standby SG-1099/FPN-60 Pulse Generator.
3. Disconnect input and output cables at rear of the PGEN.
4. Remove rack mount screws from front panel of the PGEN unit. (See Figure 1).
5. Remove PGEN unit from rack and remove cover.
6. Locate R2 on front panel and remove the two nuts on the outside.
7. Label the wires on the pot center, left, right (looking down) (see Figure 2).
8. Remove potentiometer from the rear side of the shaft hole in front panel and enlarge hole to a 3/8" diameter suitable to the new potentiometer shaft. Position the flat side of the multiturn potentiometer downward. (See Figure 3 and 4).
9. Follow instructions enclosed with the dial for proper installation. (See Figure 5).
10. Turn shaft of R2 fully counter clockwise and set dial to 0.00. Tighten screw with allen wrench after properly aligned.
11. Resolder the wires to the contacts of the multiturn potentiometer.
12. To replace the PGEN in the rack, perform steps 2 to 5 in reverse order, and adjust the vernier dial until the TDW is the same amplitude as observed in step 1.
13. Switch transmitters and perform steps 1 to 12 on the other PGEN.
14. This completes the Field Change.

F.C. NO. 4 TO AN/FPN-60



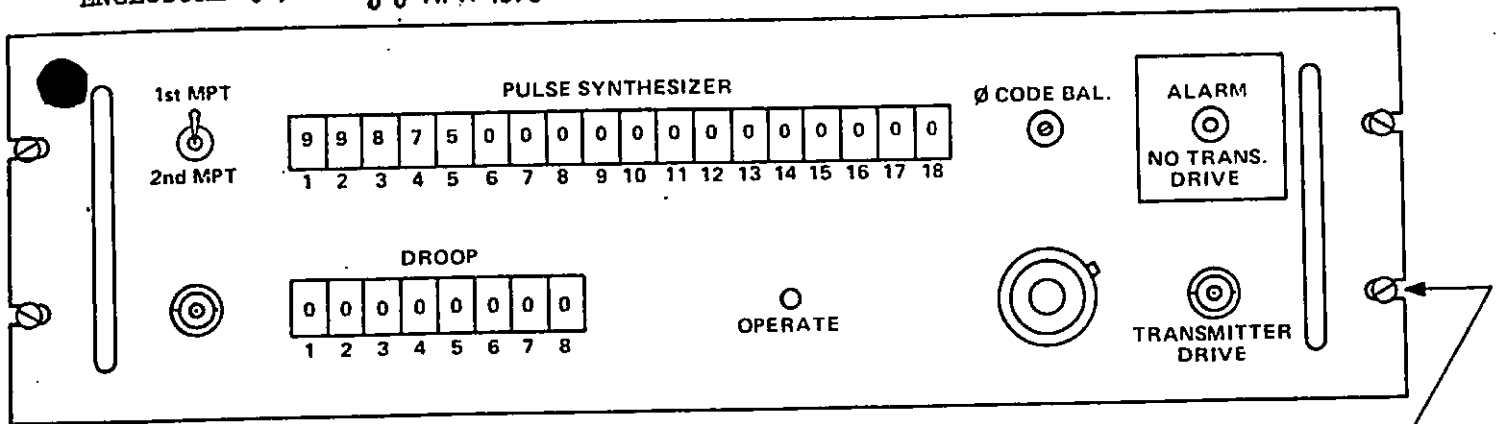


Figure 1

Front Panel Of PGEN Showing Location Of Mounting Screws

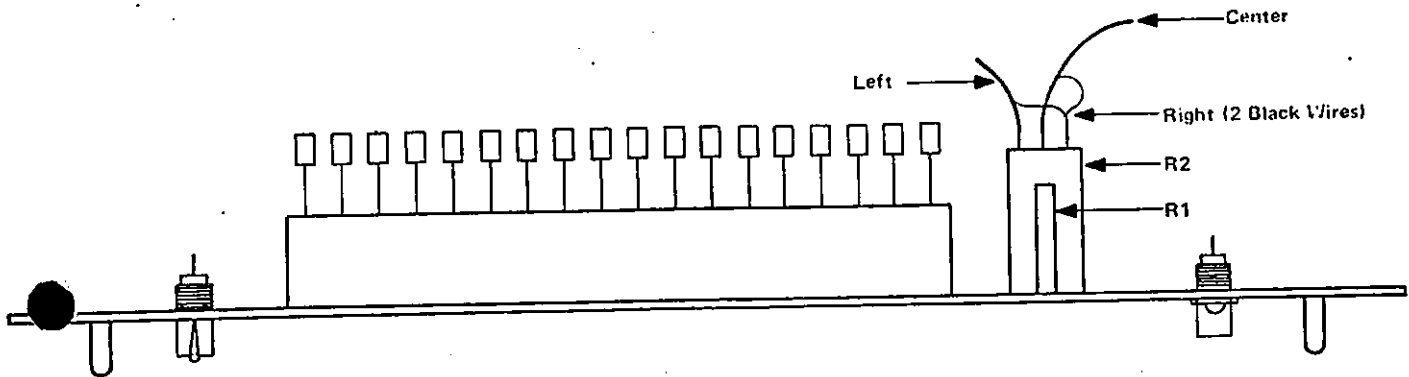
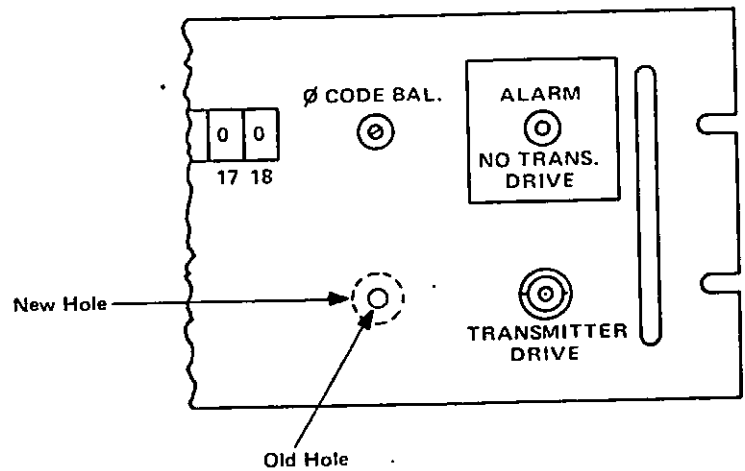


Figure 2

Top View Of Front Panel Showing Temporary Labeling Of R2 Wiring

Figure 3





30 APR 1975

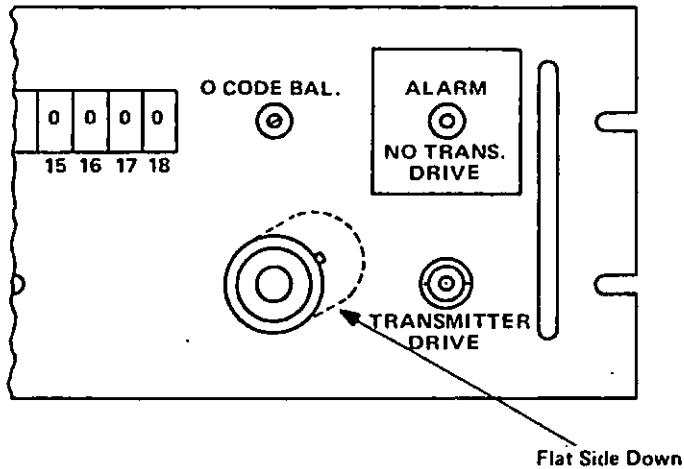


Figure 4
Front Panel Of PGEN Showing Proper Installation Of Multi-turn Potentiometer

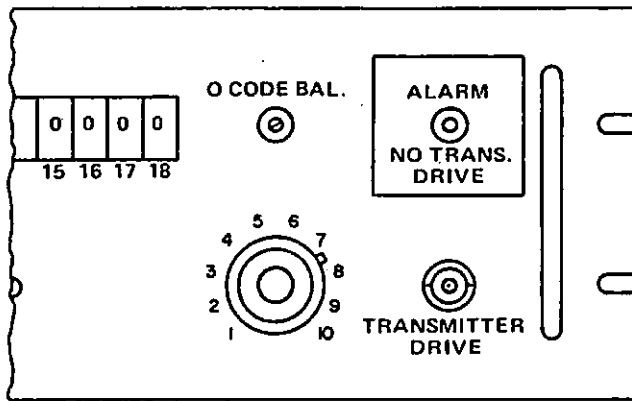


Figure 5
Front Panel Of PGEN Showing Properly Completed Proposed Field Change

F.C. NO. 4 TO AN/FPN-60



30 APR 1979

PARTS LIST FOR FIELD CHANGE
NO. 1 to AN/FPN-60

<u>ITEM</u>	<u>DESIGNATION</u>	<u>QTY</u>	<u>DESCRIPTION</u>
1	R2	1	62JA-2500, OHM/ CLAROSTAT (POT)
2		1	H-510-2 BOURN'S DIAL
3			FIELD CHANGE ACCOMPLISHED PLATE NSN IO264-00-085-0000

ITEM 2 - CLAROSTAT 462 WAS USED
IN F.C. KIT

F.C. NO. 4 TO AN/FPN-60





DEPARTMENT OF TRANSPORTATION
UNITED STATES COAST GUARD

MAILING ADDRESS (6-EEE-4/63)
U.S. COAST GUARD
WASHINGTON, D.C. 20540
PHONE (202) 426-7193

30 APR 1979

ELECTRONIC FIELD CHANGE BULLETIN

F.C. NO. 4 TYPE 1 TO AN/FPN-60 TRANSMITTER CONTROL SET

PURPOSE:

The purpose of this change is to increase the resolution of the transmitted drive adjust potentiometer on the SG-1099/FPN-60 Pulse Generator and add a vernier dial with a locking feature.

DESCRIPTION:

The Field Change consists of removing the present gain control and replacing it with a ten-turn control and adding a concentric scale incremental dial with a locking feature.

IDENTIFICATION OF ACCOMPLISHMENT:

The presence of a vernier dial on the front panel of the pulse generator identifies this change.

MATERIALS REQUIRED:

1. A Field Change No. 4 Type 1 Parts Kit and standard hand tools are necessary to perform this Field Change.
2. A list of parts contained in the Field Change Parts Kit is attached as enclosure (2) to this bulletin.
3. The Field Change Parts Kit (CG5825-01-GL7-3106) is stocked at Coast Guard Supply Center, Brooklyn, NY. Initial distribution will be by Coast Guard Supply Center, Brooklyn, NY.

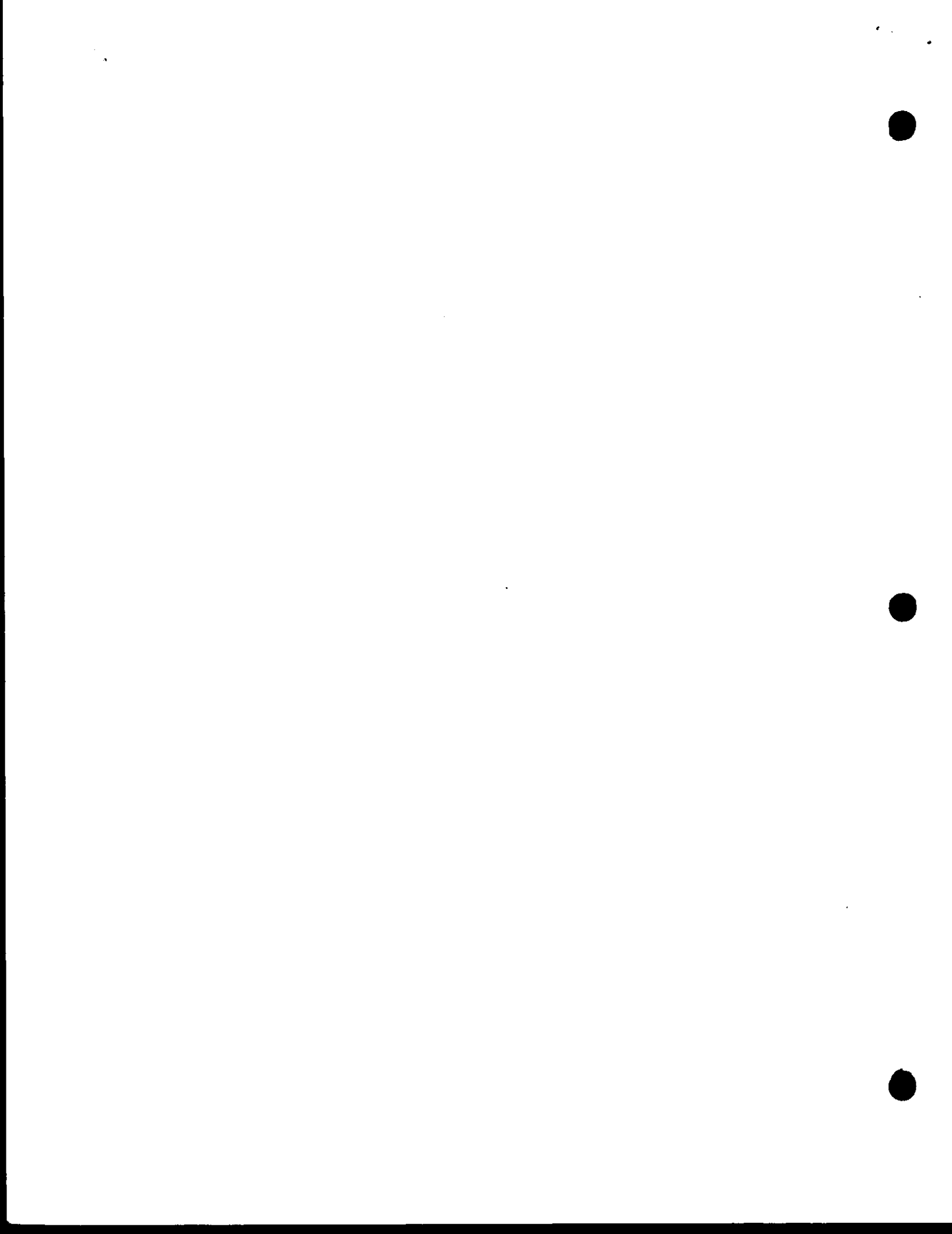
PROCEDURE:

Step-by-step installation instructions are provided as enclosure (1) to this bulletin.

DISTRIBUTION - SDL No. 109

	a	b	c	d	e	f	g	h	i	j	k	l	m	n	o	p	q	r	s	t	u	v	w	x	y	z
A																										
B		5	5				5	5								5	5		5							
C																			2			2				
D	2																									
E			2																							
F																										
G																										
H																										

NON-STANDARD DISTRIBUTION: B: (c) 1st, 2nd, 5th, 7th, 11th, 12th, 13th, 14th, 17th only (5). CG-31: Cape Race, Angissog, Sandur, Bo, Jan Mayan, Ejde, Williams Lake only (2).



ROUTINE INSTRUCTIONS: 30 APR 1979

1. For EICAM reporting purposes, report completion of this Field Change on Form CG-4334D using AN/FPN-60 as EQUIPMENT MODEL/TYPE. The serial number shall be reported as shown on the Electronic Installation Record (EIR). Report the date of Field Change installation in blocks 3 to 5 on Form CG-4334D. Record completion by an entry on the Field Change Accomplished Plate, NSN I 0264-00-085-000, and on any other required records.
2. Maintenance support facilities shall maintain a library copy of this and all other field change bulletins applicable to them. Additional or missing copies can be obtained from Coast Guard Supply Center, Brooklyn, NY (CODE 341). Order directly using MILSTAMP procedures; no cost is involved. NSN CG7610-01-GE8-1753 applies.
3. Upon completion, a copy of this Field Change Bulletin shall be inserted in the front of all applicable Technical Manuals. Cognizant commands shall ensure that the field change has been accomplished and that Technical Manual annotations and reports have been made. Coast Guard Supply Center, Brooklyn, NY, will update the Allowance Parts List to reflect any changes.

R. E. Warakomsky
R. E. WARAKOMSKY
By direction

Encl: (1) Step-by-Step Installation Instructions
(2) Parts List for Field Change Kit



30 APR 1979

STEP-BY-STEP INSTALLATION INSTRUCTIONS

1. With an oscilloscope observe and record the amplitude of the transmitter drive waveform at J2 on the front panel of the standby PGEN.
2. Secure power to the standby SG-1099/FPN-60 Pulse Generator.
3. Disconnect input and output cables at rear of the PGEN.
4. Remove rack mount screws from front panel of the PGEN unit. (See Figure 1).
5. Remove PGEN unit from rack and remove cover.
6. Locate R2 on front panel and remove the two nuts on the outside.
7. Label the wires on the pot center, left, right (looking down) (see Figure 2).
8. Remove potentiometer from the rear side of the shaft hole in front panel and enlarge hole to a 3/8" diameter suitable to the new potentiometer shaft. Position the flat side of the multiturn potentiometer downward. (See Figure 3 and 4).
9. Follow instructions enclosed with the dial for proper installation. (See Figure 5).
10. Turn shaft of R2 fully counter clockwise and set dial to 0.00. Tighten screw with allen wrench after properly aligned.
11. Resolder the wires to the contacts of the multiturn potentiometer.
12. To replace the PGEN in the rack, perform steps 2 to 5 in reverse order, and adjust the vernier dial until the TDW is the same amplitude as observed in step 1.
13. Switch transmitters and perform steps 1 to 12 on the other PGEN.
14. This completes the Field Change.

F.C. NO. 4 TO AN/FPN-60



30 APR 1979

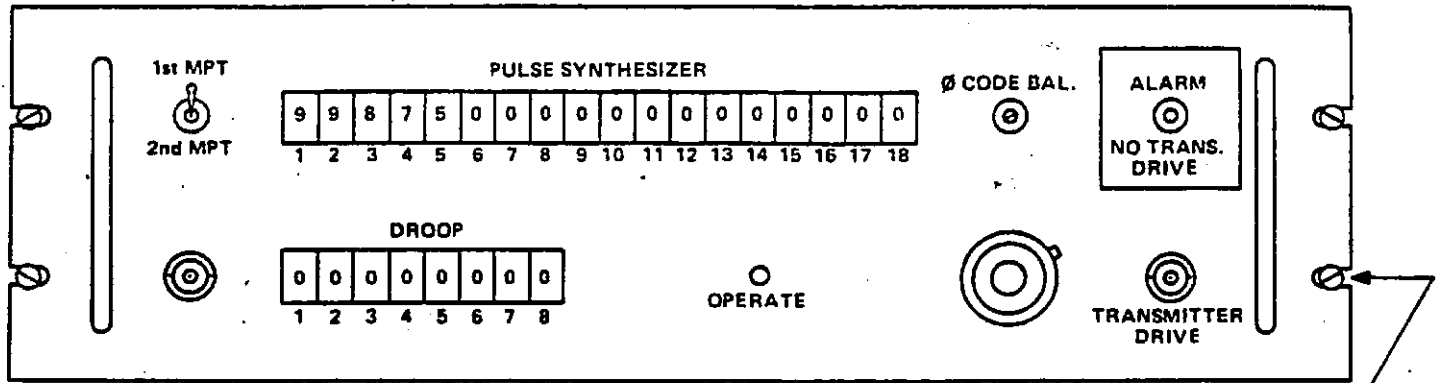


Figure 1

Front Panel Of PGEN Showing Location Of Mounting Screws

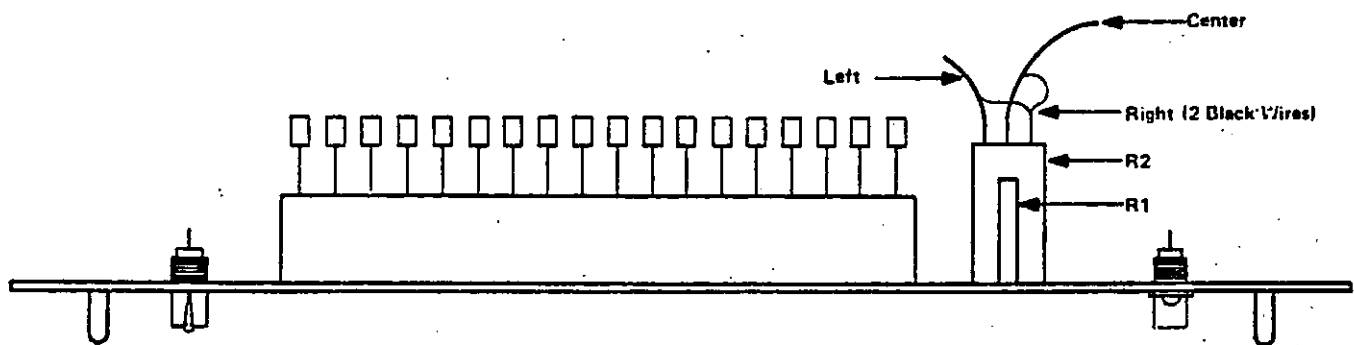
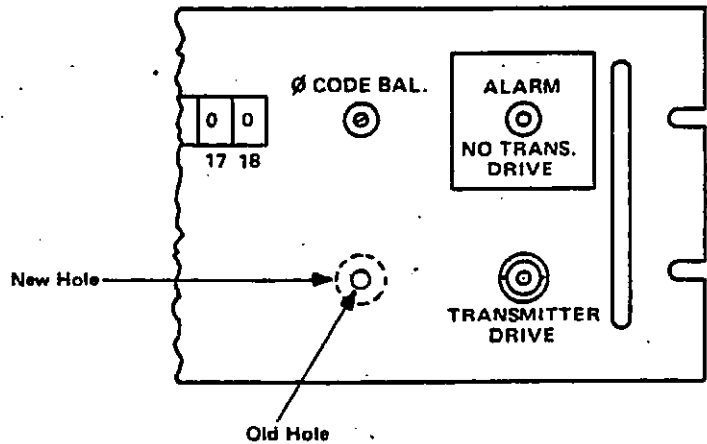
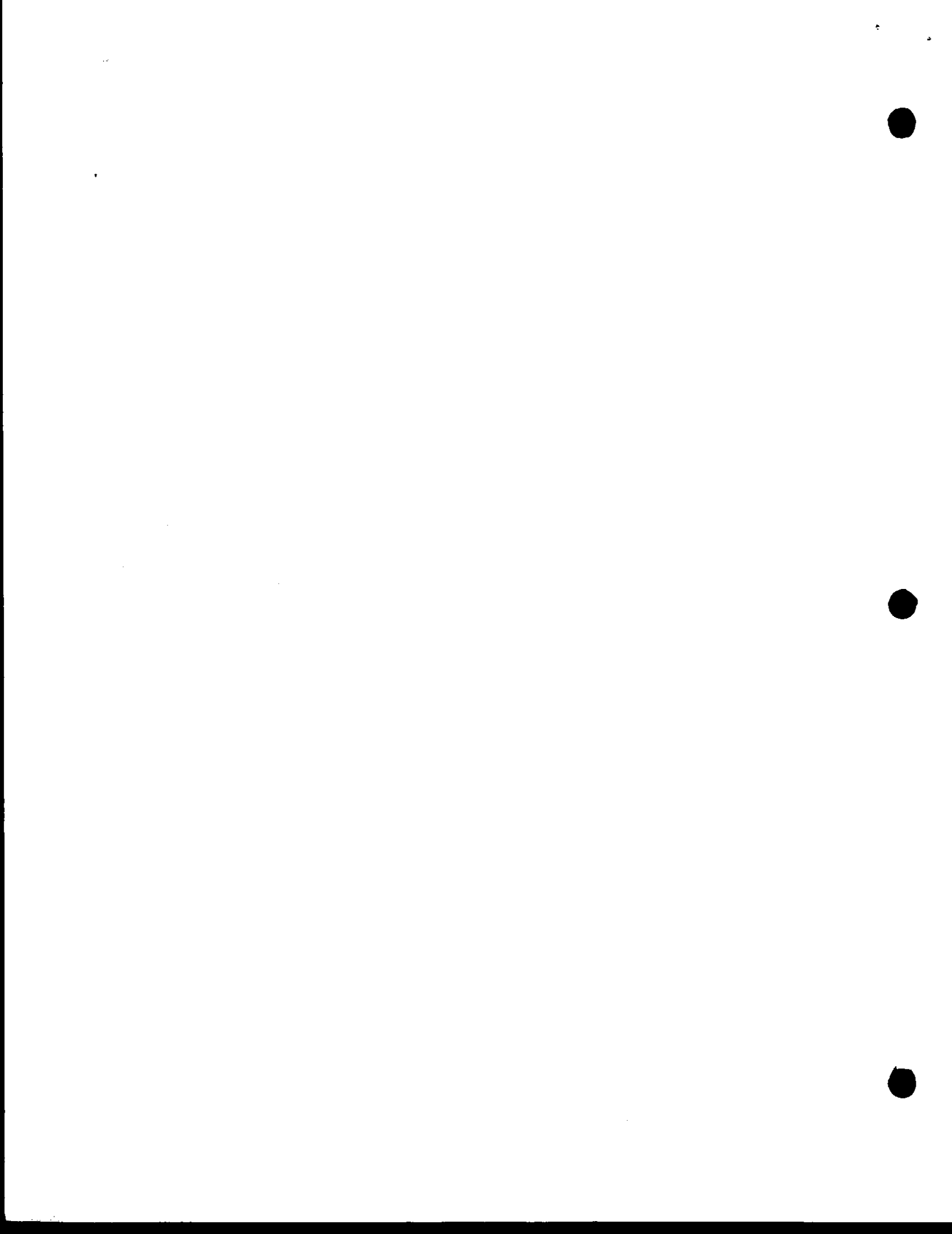


Figure 2

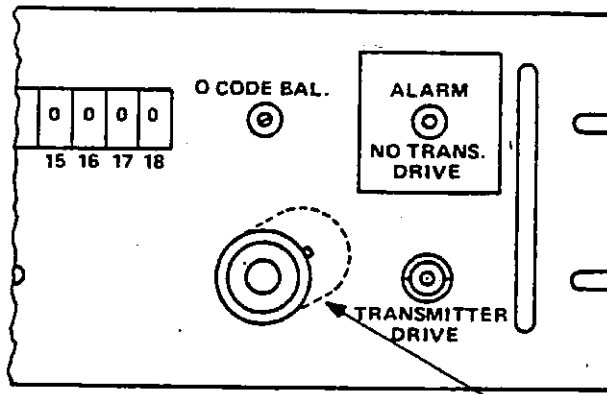
Top View Of Front Panel Showing Temporary Labeling Of R2 Wiring

Figure 3





30 APR 1975



Flat Side Down

Figure 4

Front Panel Of PGEN Showing Proper Installation Of Multi-turn Potentiometer

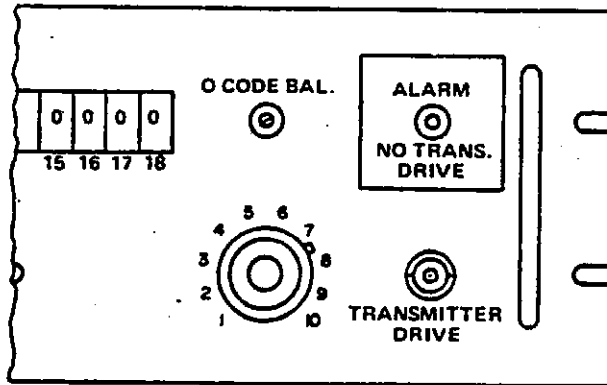


Figure 5

Front Panel Of PGEN Showing Properly Completed Proposed Field Change

F.C. NO. 4 TO AN/FPN-60

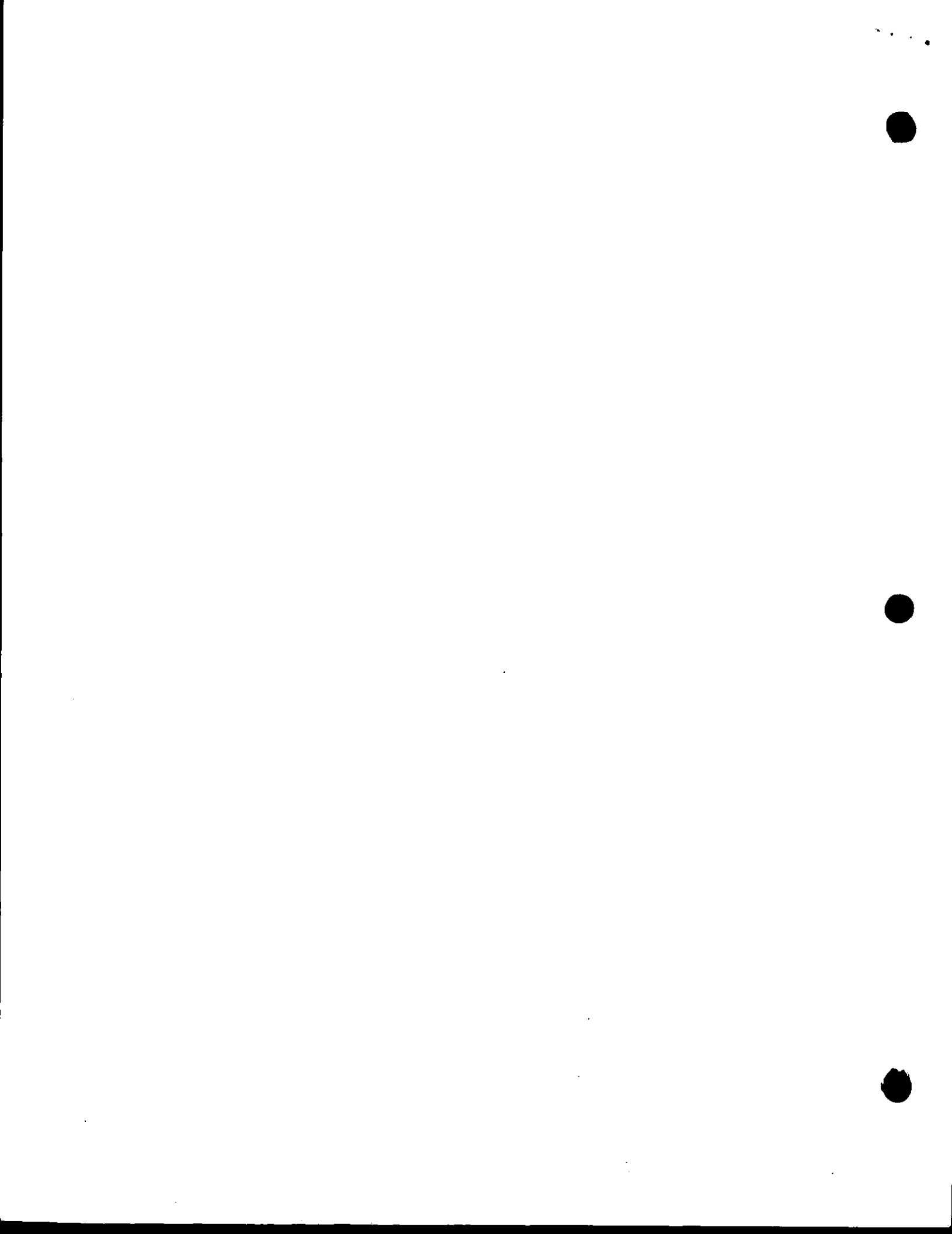


80 APR 1979

PARTS LIST FOR FIELD CHANGE
NO. 1 to AN/FPN-60

<u>ITEM</u>	<u>DESIGNATION</u>	<u>QTY</u>	<u>DESCRIPTION</u>
1	R2	1	62JA-2500, OHM/ CLAROSTAT (POT)
2		1	H-510-2 BOURN'S DIAL CLAROSTAT 462
3			FIELD CHANGE ACCOMPLISHED PLATE NSN 10264-00-085-0000

F.C. NO. 4 TO AN/FPN-60





DEPARTMENT OF TRANSPORTATION
 UNITED STATES COAST GUARD

MAILING ADDRESS: (G-EEE-4/63
 U.S. COAST GUARD
 WASHINGTON, D.C. 20590
 PHONE: (202) 426-1193

13 APR 1979

ELECTRONIC FIELD CHANGE BULLETIN

F. C. NO. 3 TYPE 1 TO AN/FPN-60 TRANSMITTER CONTROL SET

PURPOSE:

The purpose of this Field Change is to provide a modified Electrical Pulse Analyzer (EPA) TS-3550/FPN-60 for improved data collection and improved station operations.

INSTALLATION REQUIREMENT:

FC-3 to AN/FPN-60 cannot be accomplished unless FC-1, to the AN/FPN-54A and FC-2 to the AN/FPN-60 have already been accomplished.

DESCRIPTION:

The presence of a three digit thumbwheel for switch S3 on the front panel of the EPA identifies this Field Change.

MATERIALS REQUIRED:

1. A Field Change No. 3 Parts Kit (NSN CG 5825-01-GL7-3098), a modified EPA chassis and standard hand tools are needed to perform this Field Change.
2. A list of parts contained in the Parts Kit is attached as enclosure (1) to this Bulletin.
3. Initial distribution of the parts kit will be made by EECEN. Distribution of the modified EPAs will also be done by EECEN.

PROCEDURE:

1. This modification can be accomplished without securing power to the TCS rack or to the transmitters (in other words, without going off-air). Securing power to the EPA is all that is required.

DISTRIBUTION - SDL No. 105

	a	b	c	d	e	f	g	h	i	j	k	l	m	n	o	p	q	r	s	t	u	v	w	x	y	z
A																										
B	5	5							5							5	5		5							
C																			2			2				
D	2																									
E			2																							
F																										
G																										
H																										

NON-STANDARD DISTRIBUTION: B:c 1st; 2nd, 5th, 7th, 11th, 12th, 13th, 14th, 17, only (5): CG-31; Cape Race, Angissoq, Sandur, B0, Jan Mayen, Ejde, Williams Lake, only (2)



CAUTION

Insure that the step by step procedures for the removal of the EPA chassis are followed exactly, according to Enclosure (2) of this Field Change, or out of tolerance condition of the cycle loop will result.

2. During removal of the old EPA and the installation of the new EPA, the station Local Envelope Number (LEN) from the TIC panel will be unusable. After installation of the new EPA, the LEN (or any other number that uses local envelope crossover from the EPA) will increase by 10 us, because the new EPA measures ECD at 40 us instead of 30 us.
3. Step-by-step installation instructions are provided as enclosure (2).
4. Technical manual corrections are provided as enclosure (3).

ROUTINE INSTRUCTIONS:

1. For EICAM reporting purposes, report completion of this Field Change on Form CG-4334D using TS-3550/FPN-60 as EQUIPMENT/MODEL TYPE. Three entries are required as follows:

a. Report deinstallation (DI) of the unmodified TS-3550/FPN-60 using the serial number as shown on the Electronic Installation Record.

b. Report installation (NI) of the modified TS-3550/FPN-60 using the serial number as shown on the name plate of the modified EPA.

c. Report Field Change Accomplishment (FC) using the serial number of the modified TS-3550/FPN-60.

Report the date of the Field Change in blocks 3 to 8 on Form CG-4334D. Report completion by an entry on the Field Change Accomplished Plate, NSN I-0264-00-085-0000, and on any other required records.

2. Maintenance support facilities shall maintain a library copy of this, and all other Field Change Bulletins applicable to them. Additional copies can be obtained from Coast Guard Supply Center, Brooklyn, N.Y. (Code 341). Order directly using MILSTRIP procedures; no cost is involved. NSN CG 7610-01-GE8-1752 applies.

3. Upon completion, a copy of this Field Change Bulletin shall be inserted in the front of all applicable technical manuals.



Cognizant commands shall ensure that the Field Change has been accomplished and that technical manual annotations and reports have been made. Coast Guard Supply Center Brooklyn, N.Y., will update the Allowance Parts list to reflect any changes.

4. Hereafter, when ordering modules, use the correct new stock number as listed in the parts list, enclosure (1).

5. Upon completion, units shall notify Commanding Officer, Coast Guard Electronics Engineering Center, Wildwood, N.J. direct via routine message and information copy to cognizant commands.



R. E. WARAKOMSKY
By direction

Encl: (1) List of parts contained in kit
(2) Step-by-step installation instructions
(3) Technical manual corrections



Enclosure (1)

PARTS LIST FOR FIELD CHANGE NO. 3

<u>Item</u>	<u>Des.</u>	<u>Qty</u>	<u>Description</u>	<u>NSN</u>
1		15 ft*	RG-58C/U coaxial cable	
2		2*	UG-88 connectors	5935-00-835-0508
3		1*	UG-274C/U T-connector	5935-00-926-7523
4	A	1	W0678-3A/GATCON Module	XB5825-01-GL2-4591
5	D	1	W0678-11A/CLP ATTN Module	XB5825-01-GL2-4592
6	B	1	W0678-18C/ECD Module	XB5825-01-GL2-4593
7	EPA	1	TS-3550/FPN-60 Electrical Pulse Receiver, complete with modules	
8		1	Field Change Accomplished Plate	I-0265-00-085-0000

*Quantities doubled for dual rate stations.

Field Change No. 3 to AN/FPN-60



STEP-BY-STEP INSTALLATION INSTRUCTIONS

READ COMPLETELY BEFORE PROCEEDING

1. Make technical manual corrections (Note: It is important to do the technical manual corrections BEFORE doing the rest of the Field Change),
 - a. Discard pages 13, 14, 15, 16, 17, 18, 19 and 20 of the TCS manual.
 - b. This Field Change contains entire pages which are to be inserted in the TCS manual. These pages are numbered 13, 14, 15, 16, 17, 18, 19 and 20. Insert these pages in the TCS manual.
 - c. Discard pages 5, 6, 7, 8, 9, 10 of the LRE system manual.
 - d. This Field Change contains entire pages which are to be inserted in the LRE system manual. These pages are numbered 5, 6, 7, 8, 9, 10. Insert these pages in the LRE system manual.
2. Program the ECD card to be installed (which will be inside the new EPA) and the spare ECD card in accordance with the procedure on page 14 of the TCS Manual.
3. Before proceeding with the rest of the Field Change, you may opt to do part of steps 16 or 19 at this time. These steps require fabrication of a cable (for single rate stations) or 2 cables (for dual rate stations) with materials supplied in the Field Change Kit: RG-58C/U coaxial cable and UG-88 BNC connectors.

CAUTION

Observe safety precautions as outlined in Chapter 2, CG-165-1.

4. Remove the cable connected to the OPERATE RF JACK (A8 J14) on the rear panel of the C-8621A/FPN control unit for the AN/FPN-54A. On dual rated stations, disconnect cables from both control units.
5. Mark all cables which are presently plugged into the rear panel jacks of the EPA according to their respective connections, J4 through J11.
6. Remove the cables marked in step 5 from the rear panel of the EPA chassis.

Field Change No. 3 to AN/FPN-60



Enclosure (2)

7. Disconnect the EPA AC power cord from the AC power strip.
8. Remove the EPA from the TCS rack by removing the four front panel screws.
9. Remove the top cover from the new EPA.
10. Install the new EPA in the TCS rack, and connect all cables which were previously disconnected in step 6.
11. Apply AC power to the modified EPA by plugging its AC power cord into the AC outlet strip located in the back of the TCS cabinet.
12. Pull the EPA forward so that it extends part way out of the front of the TCS rack. Pull it out far enough so that you can reach the (WO678-11/CLP ATTN) Clip Attenuator module test points and potentiometers.
13. Adjust R6 and R10 of the Clip Attenuator module in accordance with the procedure on page 14 of the TCS manual. R6 is closest to the rear panel.
14. Install the top cover on the new EPA, push the new EPA all the way into the TCS rack, and secure it with the front panel screws.

NOTE: Steps 15 and 16 are for single rated stations and steps 17 through 19 are for dual rated stations; i.e, for dual rated stations, go to step 17.

15. Disconnect the OPERATE PCI cable from A8J13 of the C-8621A/FPN Timer Set Control. Connect a BNC T-connector UG-274C/U to A8J13 and reconnect the OPERATE PCI cable to one end of the T-connector.
16. Fabricate a cable with the materials supplied in the Field Change Kit (unless you have already done this in step 3), with BNC (UG-88) connectors on each end. Connect this cable to the other side of the previously installed T-connector (step 15) and J13 of the new EPA. The routing of this cable must follow the routing of existing cables between equipment racks. Go to step 20.
17. Disconnect the OPERATE RCI cable from A8J13 of the low rate* C-8621A/FPN Timer Set Control. Connect the BNC T-connector UG-274C/U to the jack and reconnect the OPERATE RCI cable to one end of the T-connector.

*Low Rate: The highest numbered rate for a dual rated station. For example: For a dual rated station of 7930 and 5930, 7930 is the low rate.



Enclosure (2)

18. Repeat step 17 for the high rate timer set control unit (C-8621A/FPN).

19. Fabricate two cables with materials supplied in the Field Change Kit (unless you have already done this in step 3), with BNC (UG-88) connectors on each end. Connect one cable between the PCI T-connector at A8J13 of the low rate Timer Set Control Unit and J13 of the EPA. Connect the other cable between the PCI-T-connector at A8J13 of the high rate Timer Set Control Unit and J12 of the EPA.

20. Check the operation of the GCF-W-678-PP Time Interval Counter (TIC) panel and the EPA you just installed by disconnecting and reconnecting the EPA AC power cord at least three times to see if the LEN number remains the same within 5 microseconds.

21. Pack the old EPA that you removed in the shipping container that the new EPA was received in. Do not remove any of the modules from the old EPA, and make sure they are inside the old EPA when you pack it.

22. Pack the spare modules for the old EPA in the containers that the modules for the new EPA came in. The old modules are of no use to you anymore since there have been extensive changes to make them work in the new EPA.

23. As soon as possible, ship the old EPA with its modules and all spare EPA modules back to EECEN, marked for "LX/WO-853-A4". The old EPA will be modified and used to accomplish the field change at another Loran-C station. The modules you will be sending back are:

- a. WO678-3/GATCON
- b. WO678-18B/ECD
- c. WO678-4/PK DET
- d. WO678-11/CLP ATTEN



ENCLOSURE (3)

TECHNICAL MANUAL CHANGES

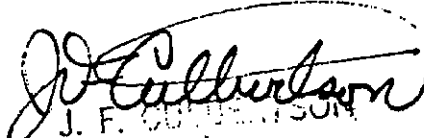
TCS MANUAL





ROUTINE INSTRUCTIONS:

1. For EICAM reporting purposes, report completion of this field change on Form CG-4334D using J-3353/FPN-60 as EQUIPMENT MODEL/TYPE. The serial number shall be reported as shown on the CGHQ-3134. Report the date of field change installation in blocks 3 to 8 on Form CG-4334D. Record completion by an entry on the Field Change Accomplished Plate, NSN I 0264-00-085-0000, and on any other required records.
2. Maintenance support facilities shall maintain a library copy of this, and all other field change bulletins applicable to them. Additional or missing copies can be obtained from Coast Guard Supply Center, Brooklyn, N.Y. Order directly, using MILSTRIP procedures; no cost is involved. NSN CG7610-01-GE8-1751 applies.
3. Upon completion, a copy of this field change bulletin shall be inserted in the front of all applicable technical manuals. Cognizant commands shall ensure that the field change has been accomplished and that technical manual annotations and reports have been made. Coast Guard Supply Center, Brooklyn, N.Y., will update the Allowance Parts List to reflect any changes.
4. Upon completion, and in addition to the required EICAM report, units shall notify EECEN (LX/SMEF) direct via routine message info cognizant commands.


J. F. CULBERTSON
By direction

Encl: (1) Step-by-step installation instructions
(2) List of parts contained in Kit

Dist: (SDL No. 106)

A: None

B: b,c (1st, 2nd, 5th, 7th, 11th, 12th, 13th, 14th, 17th only), gigs
(2); p(1)

C: sv (2)

D: a(Guam, Tokyo only) (2)

E: c(2)

F: None



STEP-BY-STEP INSTALLATION INSTRUCTIONS
READ COMPLETELY BEFORE PROCEEDING

1. Secure power to both transmitters and to the AN/FPN-60 Transmitter Control Set.

NOTE!!

AUTHORIZED OFF-AIR TIME IS REQUIRED TO PERFORM THIS FIELD CHANGE.

CAUTION

OBSERVE SAFETY PRECAUTIONS AS OUTLINED IN CHAPTER 2, CG-165-1.

2. Remove the right side panel of the TCS Rack.
3. Remove the top cover of the J-3353/FPN-60 Interface Unit.
4. Remove the four rack mount screws from the front panel of the Interface Unit.
5. Remove the front panel of the TCS Interface Unit by removing the 11 phillips-head screws. Prop the bottom front of the Interface Unit by placing a thick book or a small 2" X 4" piece of wood under it.

(Steps 5 thru 11 refer to Figure 1)

6. Install a 680 ohm 1/4 watt resistor between terminals 6 and 32 of TB4. The resistor lead going to terminal 32 should be left long enough to connect to terminal 33. (DO NOT CONNECT TO TERMINAL 33 AT THIS TIME!)
7. Install a 680 ohm 1/4 watt resistor between terminals 26 and 52 of TB3.
8. Install a jumper wire between TB3 terminal 26 and J22 pin 10. Use heat shrink tubing on the wire connected to J22.
9. Install a jumper wire between TB3 terminals 12 and 52.
10. Install a jumper wire between TB4 terminal 6 and J20 pin 2. Use heat shrink tubing on the wire connected to J20.

Field Change No. 2 To AN/FPN-60



Enclosure (1)

11. Connect the long resistor lead (Step 5) to TB4 terminal 33. Make sure all leads are soldered. This completes the installation steps of the field change. Return TCS Interface to normal by removing prop, replacing front and top panels, and securing in the rack cabinet. Restore power.

12. Remove the original page 30, TCS Interface Wiring Diagram, from the equipment technical manual and insert the new page provided.

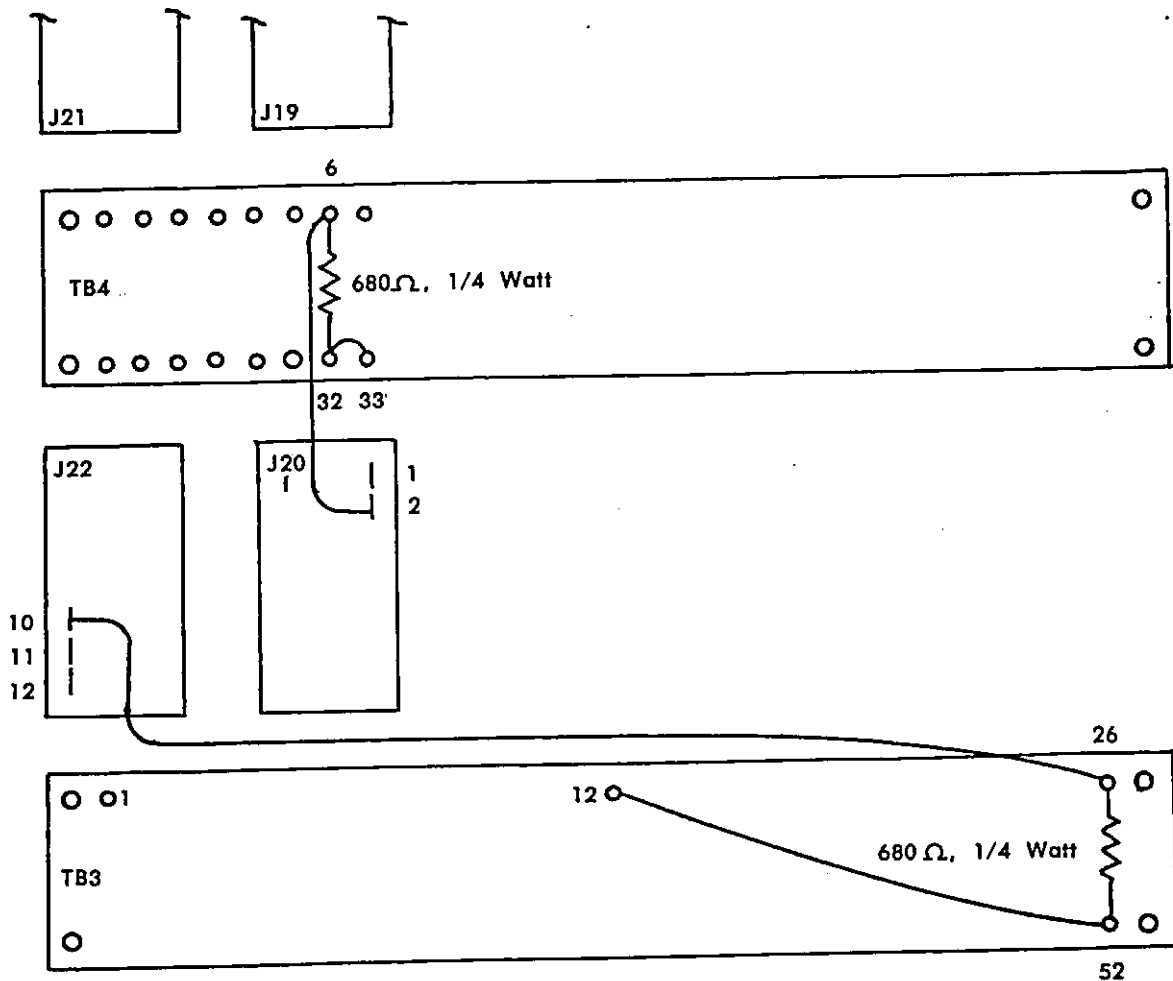


Figure 1: J3353/FPN-60 Interface
Connections For MPT To EPA



PARTS LIST FOR FIELD CHANGE KIT

ITEM	DESIGNATION	DESCRIPTION	AMT.
1	R46	680 ohm, 1/4 watt resistor	1
2	R47	680 ohm, 1/4 watt resistor	1
3		#22 stranded TFE hookup wire	2 ft.
4		3/32 inch TFE heat shrinkable tubing	2 in.
5		Field Change Accomplished Plate	1





ROUTINE INSTRUCTIONS:

1. For EICAM reporting purposes, report completion of this field change on Form CG-4334D using TS-3550/FPN-60 as EQUIPMENT MODEL/TYPE. The serial number shall be reported as shown on the CGHQ-3134. Report the date of field change installation in blocks 3 to 8 on form CG-4334D. Record completion by an entry on the Field Change Accomplishment Plate, NSN I 0264-00-085-000, available from NPFC, Philadelphia, and on any other required records.

2. Maintenance support facilities shall maintain a library copy of this, and all other field change bulletins applicable to them. Additional or missing copies can be obtained from Coast Guard Supply Center, Brooklyn, N.Y. Order directly, using MILSTRIP procedures; no cost is involved. NSN CG-7610-01-GE8-1750 applies.

3. Upon completion, a copy of this field change bulletin shall be inserted in the front of all applicable technical manuals. Cognizant commands shall ensure that the field change has been accomplished and that technical manual annotations and reports have been made. Coast Guard Supply Center, Brooklyn, N.Y., will update the Allowance Parts List to reflect any new changes.

E. E. Warachinsky
E. E. WARACHINSKY
By Direction

Encl: (1) Step-by-Step Installation Instructions
(2) List of Parts Contained in Kit

DIST: (SDL NO. 105)

A: NONE

B: b,c(1st, 2nd, 5th, 7th, 11th, 12th, 13th, 14th, 17th only),
giqs(2); p(1)

C: sv(2)

D: a(Guam, Tokyo only)(2)

E: c(2)

F: NONE



STEP-BY-STEP INSTALLATION INSTRUCTIONS

1. Secure power 115 VAC to the TS-3550/FPN-60 EPA.
2. Remove interconnect cables from back of the EPA and connect the cable removed from J7 into the cabinet dummy load.
3. Remove the EPA from the LRE rack.
4. Remove the top cover of the EPA.
5. Locate the 5 VDC DATEL POWER CUBE inside the EPA chassis.
6. Remove the four 6-32 panhead phillips screws which mount the power cube to the EPA chassis.
7. Apply a thin coat of silicone insulating compound to the top side of the DATEL POWER CUBE.
8. Remove the four 1" threaded spacers on which the power cube is mounted and replace with the four 1.25" threaded spacers provided.
9. Heatsink the power cube to the EPA chassis by turning the entire power cube upside down (bottom up). Secure the power cube to the EPA chassis with the four 6-32 screws removed in step 6. (See Figure 1).
10. Replace the top cover on the EPA.
11. Install the EPA back into the AN/FPN-60 LRE rack.
12. Reconnect all interconnect cables removed in Step 2.
13. Reconnect 115 VAC power to the EPA and observe readings. EPA should operate normally.

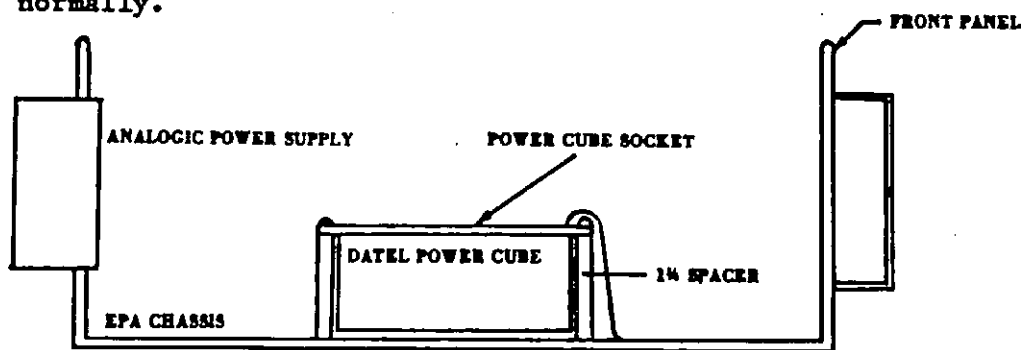


Figure 1

Field Change No. 1 To AN/FPN-60



PARTS LIST FOR FIELD CHANGE NO. 1 PARTS KIT

<u>ITEM</u>	<u>QTY</u>	<u>DESCRIPTION</u>
1	4	1.250" threaded metal spacer
2	1	One tube silicone insulating compound.

12.1





F.S.M.B.

Information Report



Date: 23 May 86

From FSMB

To SM

Subject: AN/FPN-60 TECH MANUAL

Discussion: THE WAVEFORM PANELS (SB-4156/FPN-60)
PICTURED ON PAGES 1.7 (FIG 1.7), 2.11 (FIG 2.11), AND
3.8 (FIG 3.5) SHOW TWO DIFFERENT PANELS.

PANEL ON PAGE 1.7 IS BELIEVED TO BE CORRECT.

PANELS ON PAGES 2.11 AND 3.8 IS A SB-4155/FSN-3
U/W AN/FSN-3 LSM SET. THIS PANEL IS SHOWN
ON PAGE 1.6 OF THE LSM. TECH MANUAL

Submitted By: [Signature] FSMB Branch Chief: [Signature]

Copies To: LC





To: Chief, SM Branch
Fr: Chief, FM Branch

Date 4 MAR 86

EQUIPMENT: AN/FPN-60 TECH MANUAL

REPORTED BY: ETZ COLLINS
(Name)

FSMB
(Ship, Station, Branch, Etc.)

X283
(Telephone Number) FTS < > COML < >

DESCRIPTION OF PROBLEM

MISSING INFORMATION ON PAGE 7.63/7.64
PULSE GENERATOR WIRING DIAGRAM (FIG 7.31)
NOTE 2 STEP K SHOULD BE C-73 TO A30 VICE -73 TO A-30

Information Furnished/Requested

REQUEST T.M. BE UPDATED

FSMB Personnel Receiving Info: [Signature] X283
(Name) (Ext)

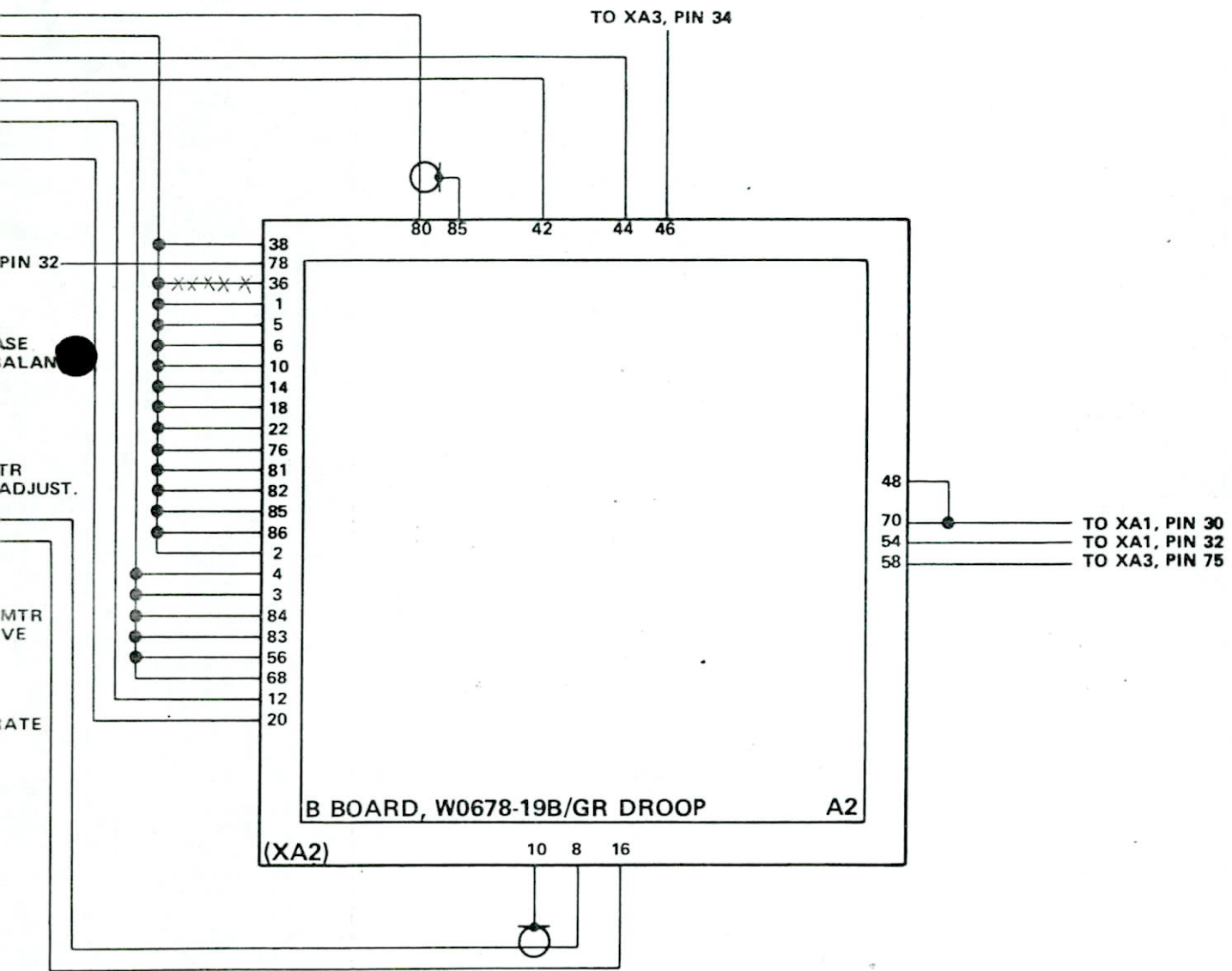
Action/Info [Signature]
FM Br. Ch. SM Br. Ch. _____



NOTES:

1. THIS WIRING DIAGRAM IS FOR STATIONS (DUAL or SINGLE-RATED) WITH TAIL DRIVE.
2. FOR A DUAL-RATED STATION WITHOUT TAIL DRIVE; REMOVE JUMPERS a - i, and ADD JUMPERS j, k and l.

a. B-42 to A-61	e. B-70 to A-30	i. C-81 to A-30
b. B-44 to C-39	f. B-54 to A-32	j. C-75 to A-32
c. B-46 to C-34	g. B-58 to C-75	k. -73 to A-30
d. B-48 to B-70	h. C-61 to B-54	l. A-61 to C-39
3. FOR A SINGLE-RATED STATION WITHOUT TAIL DRIVE, PERFORM THE INSTRUCTIONS OF NOTE 2, and ADD A JUMPER FROM B-8 to B-16.
4. S2A USED FOR FULL CYCLE CONTROL. S2A and S2B USED FOR HALF-CYCLE CONTROL.
5. J4 and J6 NOT NORMALLY USED.





DISCREPANCY REPORT

Date 4 Nov 85EQUIPMENT AN/FPN-60 TECH MANUALREPORTED BY ETCS ARNOLD
(name)~~FSMB~~ FSMB
(ship, station, branch)X283
(tel. nr.)

Description of Problem

R1 in the 6 SS-1099/FPN-60s AT FSMB ~~PRE~~ ARNOLD
273-1-502M VAR RESISTORS (5K).

Page 6.6 of the Tech manual (Parts List) List 1A4~1A7 R1
as Resistor, variable 50K vice 5K and P/N is
2735-1-502M vice 273-1-502M

Information Furnished/Requested

Request Part list be corrected

ASAB Personnel receiving info: _____ (name) _____ (ext)

Action/info: _____
NS Br. Ch. CM Br. Ch.



TABLE OF CONTENTS

Paragraph		Page
CHAPTER 1. GENERAL INFORMATION		
1.1	Introduction	1.1
1.2	General Description	1.1
1.3	Unit Description	1.4
1.3.1	Switch Assembly (1A1)	1.4
1.3.2	Transmitter Coupler Control (1A2)	1.5
1.3.3	Electrical Pulse Analyzer (1A3)	1.5
1.3.4	Pulse Generator (1A4-1A7)	1.6
1.3.5	Waveform Panel (1A8)	1.7
1.3.6	Interface Unit (1A9)	1.8
1.3.7	EPA Dummy Load Junction Box (1A10)	1.8
1.3.8	TCC Dummy Load Junction Box (1A11)	1.8
1.4	Reference Data	1.8
1.5	Inquiries	1.12
1.6	Abbreviations	1.12
1.7	Safety Precautions	1.12
1.7.1	Reference Publications	1.12
1.7.2	Notes, Warnings, and Cautions	1.12
CHAPTER 2. INSTALLATION		
2.1	Introduction	2.1
2.2	Unpacking and Initial Inspection	2.1
2.3	Installation Instructions	2.2
2.3.1	Materials	2.2
2.3.2	Electrical Equipment Cabinet	2.2
2.3.3	Switch Assembly	2.6
2.3.4	Transmitter Coupler Control	2.6
2.3.5	Electrical Pulse Analyzer	2.6
2.3.6	Pulse Generator	2.6
2.3.7	Waveform Panel	2.7
2.3.8	Interface Unit	2.7
2.4	Installation Drawings	2.8
2.5	Adjustments and Programming	2.8
2.5.1	Electrical Pulse Analyzer Programming	2.8
2.5.2	Pulse Generator Programming	2.8
2.5.3	Group Droop Module Programming	2.12
2.6	Initial Operation	2.13
2.6.1	Equipment Turn-on	2.13
2.6.2	Power Supplies	2.13
2.6.3	Electrical Pulse Analyzer Initial Operation	2.13
2.6.4	Transmitter Coupler Control Initial Operation	2.18
2.6.5	Pulse Generator Initial Operations for Dual-Rated Stations	2.19
2.6.6	Operational Checks	2.27
2.6.7	TCS Input Signals	2.35
2.6.8	TCS Output Signals	2.36
2.7	Tail-Drive Adjustment	2.36
2.7.1	Group Droop Module Initial Settings	2.36
2.8	De-Installation and Shipping	2.40

TABLE OF CONTENTS (Cont'd)

Paragraph		Page
CHAPTER 3. OPERATION		
3.1	Introduction	3.1
3.2	Controls and Indicators	3.1
3.2.1	Switch Assembly	3.1
3.2.2	Transmitter Coupler Control	3.2
3.2.3	Electrical Pulse Analyzer	3.4
3.2.4	Pulse Generator	3.7
3.2.5	Waveform Panel	3.8
3.3	Operating Procedures	3.9
3.3.1	Equipment Turn-on	3.9
3.3.2	Modes of Operation	3.9
3.3.3	Equipment Turn-off	3.11/3.12
3.3.4	Emergency Turn-off	3.11/3.12
CHAPTER 4. THEORY OF OPERATION		
4.1	Introduction	4.1
4.2	Functional Description	4.1
4.2.1	Switch Assembly	4.1
4.2.2	Transmitter Coupler Control	4.1
4.2.3	Electrical Pulse Analyzer	4.1
4.2.4	Pulse Generator	4.1
4.2.5	Waveform Panel	4.2
4.2.6	Interface Unit	4.2
4.3	Unit Description	4.2
4.3.1	Transmitter Coupler Control	4.2
4.3.2	Electrical Pulse Analyzer	4.3
4.3.3	Pulse Generator	4.6
4.3.4	Interface Unit	4.7
4.4	Time Ladder Diagrams	4.8
CHAPTER 5. MAINTENANCE		
5.1	Maintenance Policy	5.1
5.2	Preventive Maintenance	5.1
5.2.1	Electrical Equipment Cabinet	5.1
5.2.2	Switch Assembly	5.1
5.2.3	Transmitter Coupler Control	5.1
5.2.4	Electrical Pulse Analyzer	5.1
5.2.5	Pulse Generator	5.1
5.2.6	Waveform Panel	5.1
5.2.7	Interface Unit	5.1
5.3	Corrective Maintenance	5.2
5.3.1	Troubleshooting Guide	5.2
5.3.2	Test Point Data	5.25
5.3.3	Adjustments and Repair	5.38
CHAPTER 6. PARTS LIST		
6.1	Introduction	6.1

TABLE OF CONTENTS (Cont'd)

Paragraph		Page
	CHAPTER 7. DIAGRAMS AND SCHEMATICS	
7.1	Introduction	7.1/7.2
	APPENDIX A. TCE/TRANSMITTER DIAGRAMS AND SCHEMATICS	
A.1	Introduction	A.1/A.2
	APPENDIX B. ROS MODIFICATIONS TO AN/FPN-60(V) TRANSMITTER CONTROL SET	
B.1	J-3353/FPN-60A(V) Interface Unit	B.1
B.2	SA-2063/FPN-60A(V) Emergency Stop Switch	B.2
B.3	TS-3550/FPN Electrical Pulse Analyzer (EPA)	B.2

LIST OF ILLUSTRATIONS

Figure		Page
CHAPTER 1. GENERAL INFORMATION		
1.1	AN/FPN-60(V)2 Transmitter Control Set Dual-Rate Configuration)	1.2
1.2	AN/FPN-60(V)1 Transmitter Control Set (Single-Rate Configuration)	1.3
1.3	1A1-Switch Assembly SA-2063/FPN-60(V)	1.5
1.4	1A2-Transmitter Coupler Control C-9888/FPN-60(V)	1.5
1.5	1A3-Electrical Pulse Analyzer TS-3550/FPN	1.6
1.6	1A4-1A7 - Pulse Generator SG-1099/FPN-60	1.7
1.7	1A8-Waveform Panel SB-4156/FPN-60(V)	1.7
1.8	1A9-Interface Unit J-3353/FPN-60(V)	1.8
1.9	Interrelationship of TCS Units	1.11
CHAPTER 2. INSTALLATION		
2.1	Chassis and Cabinet Grounding Details for Overhead Ducting	2.4
2.2	Electrical Equipment Cabinet (Rearview)	2.5
2.3	EPA Rear Panel Location of Switch S5	2.6
2.4	Twin-axial Polarity	2.7
2.5	Pictorial of EPA Chassis Programming	2.8
2.6	Switch Assembly	2.9
2.7	Transmitter Coupler Control	2.9
2.8	Electrical Pulse Analyzer	2.10
2.9	Pulse Generator	2.10
2.10	Waveform Panel	2.11
2.11	Interface Unit	2.11
2.12	Test Point and Potentiometer Locations	2.12
2.13	Programming of W0678-19B/GR DROOP Module Headers for AN/FPN-44/44A/45 Transmitters	2.12
2.14	W0678-19B/GR DROOP Module Changes	2.12
2.15	Programming of W0678-19B/GR DROOP Module Headers for AN/FPN-42 Transmitters	2.13
2.16	Sample Gate Versus Operate RF	2.14
2.17	Oscilloscope Connections for Monitoring EPA Waveforms	2.15
2.18	Top View of EPA Showing Location of Clip Attenuator Module	2.16
2.19	Clip Attenuator Waveform Adjust	2.16
2.20	Oscilloscope Twinax Connector Setup	2.18
2.21	Proper Phase Code Amplitude Balance	2.21
2.22	Improper Phase Code Amplitude Balance	2.21
2.23	Oscilloscope Setup	2.22
2.24	DC Reference Level	2.23
2.25	Opposite Rate Ladder Waveform	2.23
2.26	Same Rate Ladder Waveform	2.24
2.27	Crossing Ladder Waveforms	2.24
2.28	Proper Same Rate Ladder Waveform	2.25
2.29	Proper Opposite Rate Ladder Waveform	2.26
2.30	A+B Waveform	2.26
2.31	AN/FPN-39 Local Control Panel and Low Power Units	2.28
2.32	An/FPN-42 Antenna Coupler and Power Supply Panels	2.29

LIST OF ILLUSTRATIONS (Cont'd)

Figure

2.33	AN/FPN-44/45 Local Control and Control Indicator Panels	2.30
2.34	AN/FPN-44A Local Control and Control Indicator Panels	2.31
2.35	Q4 and C10 Locations	2.37
2.36	Transmitter Drive Waveform without Tail Drive	2.38
2.37	Transmitter Drive Waveform with Tail Drive	2.39
2.38	RF Waveform and Reference Envelope without Tail Drive	2.39
2.39	RF Waveform and Reference Envelope with Tail Drive	2.39
2.40	EPA Dummy Load Internal Wiring	2.40
2.41	TCC Dummy Load Internal Wiring	2.41/2.42

CHAPTER 3. OPERATION

3.1	Switch Assembly	3.2
3.2	TCC Controls and Indicators	3.3
3.3	EPA Controls and Indicators	3.5
3.4	PGEN Controls and Indicators	3.8
3.5	Waveform Panel Control	3.8
3.6	Equipment Setup for Pulse Shape Monitoring	3.9
3.7	Equipment Setup for Pulse Amplitude Monitoring	3.10
3.8	Equipment Setup for Half-Cycle Amplitude Monitoring	3.11/3.12
3.9	Equipment Setup for Droop and Phase Code Monitoring	3.11/3.12

CHAPTER 4. THEORY OF OPERATION

4.1	Master Station Time-Ladder Diagram	4.8
4.2	Secondary Station Time-Ladder Diagram	4.8

CHAPTER 5. MAINTENANCE

5.1	Transmitter Control Set (TCS) Troubleshooting Flow Chart	5.3/5.4
5.2	Transmitter Coupler Control (TCC) Troubleshooting Flow Chart (Sheet 1 of 2)	5.5/5.6
5.3	Transmitter Coupler Control (TCC) Troubleshooting Flow Chart (Sheet 2 of 2)	5.7/5.8
5.4	Electrical Pulse Analyzer (EPA) Troubleshooting Flow Chart (Sheet 1 of 6)	5.9/5.10
5.5	Electrical Pulse Analyzer (EPA) Troubleshooting Flow Chart (Sheet 2 of 6)	5.11/5.12
5.6	Electrical Pulse Analyzer (EPA) Troubleshooting Flow Chart (Sheet 3 of 6)	5.13/5.14
5.7	Electrical Pulse Analyzer (EPA) Troubleshooting Flow Chart (Sheet 4 of 6)	5.15/5.16
5.8	Electrical Pulse Analyzer (EPA) Troubleshooting Flow Chart (Sheet 5 of 6)	5.17/5.18
5.9	Electrical Pulse Analyzer (EPA) Troubleshooting Flow Chart (Sheet 6 of 6)	5.19/5.20

LIST OF ILLUSTRATIONS (Cont'd)

Figure

5.10	Pulse Generator (PGEN) Troubleshooting Flow Chart (Sheet 1 of 2)	5.21/5.22
5.11	Pulse Generator (PGEN) Troubleshooting Flow Chart (Sheet 2 of 2)	5.23/5.24
5.12	Voltage Test Point and Adjustment Locations of the TCC Power Supplies	5.25
5.13	Test Point and Potentiometer Locations of the TCC Modules	5.25
5.13a	Power Supply Voltage Test Points of the Transmitter Coupler Control	5.26
5.14	PS1 and CLP ATTN Test Point and Adjustment Locations	5.26A
5.15	PK DET, GATCON, and ECD Test Point Locations	5.26A
5.15a	Power Supply Voltage Test Points of the Electrical Pulse Analyzer	5.26B
5.16	Operate RF Waveform	5.27
5.17	Full Wave Rectified RF Waveform	5.27
5.18	Reference Envelope Waveform	5.27
5.19	Sample Gate Waveform	5.28
5.20	Local Envelope Crossover Trigger	5.28
5.21	Peak Detector Reset Waveform	5.28
5.22	Data Strobe Waveform	5.29
5.23	ECD Ramp Voltage Waveform	5.29
5.24	MPT Count and Select Strobe Generator Waveform	5.29
5.25	MPT Count and Select (Output of U17) Waveform	5.30
5.26	Half-Cycle Pulse Select Waveform	5.30
5.27	Low Pass Filter Output to Envelope Hard Limiter Waveform	5.30
5.28	Attenuated RF	5.31
5.29	Peak Volts Waveform	5.31
5.30	Count Waveform	5.31
5.31	Switching Gate Output to Envelope Hard Limiter Waveform	5.32
5.32	Voltage Test Point and Adjustment Locations of the PGEN Power Supply	5.32
5.32a	Power Supply Voltage Test Points of the Pulse Generator	5.32A
5.33	Test Point and Potentiometer Locations of the PGEN Modules	5.33
5.34	Transmitter Drive Waveform (2nd MPT)	5.33
5.35	Transmitter Drive Waveform (1st MPT)	5.34
5.36	Transmitter Drive Waveform	5.34
5.37	Phase Code Waveform (Positive Slope Triggered)	5.34
5.38	Phase Code Waveform (Negative Slope Triggered)	5.35
5.39	100 kHz Input	5.35
5.40	Local Interval	5.35
5.41	MPTs	5.36
5.42	Phase Code Reset Waveform (Negative Slope Triggered)	5.36
5.43	Phase Code Reset Waveform (Positive Slope Triggered)	5.36
5.44	Phase Code Set Waveform (Negative Slope Triggered)	5.37

LIST OF ILLUSTRATIONS (Cont'd)

Figure

5.45	Phase Code Set Waveform (Positive Slope Triggered)	5.37
5.46	Gate-H Waveform	5.37
5.47	100 kHz AM Tail	5.38
5.48	Individual Switch Section Connector Diagram	5.41/5.42

CHAPTER 7. DIAGRAMS AND SCHEMATICS

7.1	Loran-C System Block Diagram	7.3/7.4
7.2	Transmitter Control Set Functional Block Text Diagram	7.5/7.6
7.3	TCS Internal Cable Interconnect Diagram	7.7/7.8
7.4	Cable Interconnect Diagram Between TCS and Other Units	7.9/7.10
7.5	Transmitter/TCC System Control Logic Flow Diagram Connected to AN/FPN-39 TCC System Status Wiring Diagram	7.11/7.12
7.6	Transmitter/TCC System Control Logic Flow Diagram Connected to AN/FPN-39 TCC System Control Wiring Diagram	7.13/7.14
7.7	Interconnect Diagram for Transmitter Control Set LRE/AN/FPN-39 for Automatic Remote Control	7.15/7.16
7.7A	Emergency Stop Switch ROS Modification Interconnection Diagram	7.15A/7.16A
7.8	Transmitter/TCC System Control Logic Flow Diagram Connected to AN/FPN-42/TCC System Status Wiring Diagram	7.17/7.18
7.9	Transmitter/TCC System Control Logic Flow Diagram Connected to AN/FPN-42/TCC System Control Wiring Diagram	7.19/7.20
7.10	Interconnect Diagram for LRE/AN/FPN-42 Transmitter Set for Automatic Remote Control	7.21/7.22
7.11	Transmitter/TCC System Control Logic Flow Diagram Connected to AN/FPN-44/TCC System Status Wiring Diagram	7.23/7.24
7.12	Transmitter/TCC System Control Logic Flow Diagram Connected to AN/FPN-44/TCC System Control Wiring Diagram	7.25/7.26
7.13	Interconnect Diagram for LRE/AN/FPN-44 Transmitter Set for Automatic Remote Control	7.27/7.28
7.14	Transmitter Coupler Control Functional Block Text Diagram	7.29/7.30
7.15	Transmitter Coupler Control Wiring Diagram	7.31/7.32
7.16	W0678-5/XMTR CON Module Schematic	7.33/7.34
7.17	W0678-5/XMTR CON Module Parts Locator	7.35/7.36
7.18	W0678-6/XMTR CON DVR Module Schematic	7.37/7.38
7.19	W0678-6/XMTR CON DVR Module Parts Locator	7.39/7.40
7.20	Electrical Pulse Analyzer Functional Block Text Diagram	7.41/7.42
7.21	Electrical Pulse Analyzer Wiring Diagram	7.43/7.44
7.22	W0678-3A/GATCON Module Schematic	7.45/7.46

LIST OF ILLUSTRATIONS (Cont'd)

Figure

7.23	W0678-3A/GATCON Module Parts Locator	7.47/7.48
7.24	W0678-18C/ECD Module Schematic	7.49/7.50
7.25	W0678-18C/ECD Module Parts Locator	7.51/7.52
7.26	W0678-4/PK DET Module Schematic	7.53/7.54
7.27	W0678-4/PK DET Module Parts Locator	7.55/7.56
7.28	W0678-11A/CLP ATTN Module Schematic	7.57/7.58
7.29	W0678-11A/CLP ATTN Module Parts Locator	7.59/7.60
7.30	Pulse Generator Functional Block Text Diagram	7.61/7.62
7.31	Pulse Generator Wiring Diagram	7.63/7.64
7.32	W0678-1PSYN Module Schematic	7.65/7.66
7.33	W0678-1PSYN Module Parts Locator	7.67/7.68
7.34	W0678-19B/GR DROOP Module Schematic	7.69/7.70
7.35	W0678-19B/GR DROOP Module Parts Locator	7.71/7.72
7.36	W0678-2/PCON Module Schematic	7.73/7.74
7.37	W0678-2/PCON Module Parts Locator	7.75/7.76
7.38	Interface Unit Wiring Diagram	7.77/7.78
7.39	Interface Unit Wiring Diagram (ROS)	7.79/7.80

APPENDIX A. TCE/TRANSMITTER DIAGRAMS AND SCHEMATICS

A.1	Transmitter Selector/Bias Pedestal Drive Module and Bias Pedestal Generator Operating Instructions	A.3/A.4
A.2	Schematic Diagram of Power Distribution Box Unit 4A3, Module for LRE/AN/FPN-39	A.5/A.6
A.3	AN/FPN-39 LRE RF Amplifier (New UD 2A1)	A.7/A.8
A.4	Transmitter Wiring Changes for Installation of LRE/AN/FPN-39	A.9/A.10
A.5	PP-2540/FPN-42 Control Circuit Schematic Diagram (Partial Wiring of LRE Modifications)	A.11/A.12
A.6	Antenna Coupler CU-807/FPN-42 Wiring Diagram	A.13/A.14
A.7	W0725-1B/TS/BPD Module Schematic	A.15/A.16
A.8	W0725-1B/TS/BPD Module Parts Locator	A.17/A.18
A.9	AN/FPN-44 Bias Pedestal Generator Modified for Loran Replacement Equipment	A.19/A.20
A.10	AN/FPN-44 Transmitter Drive and Trigger Circuit Modification to Accommodate Loran Replacement Equipment	A.21/A.22
A.11	LRE Time Delay Defeat Circuitry (K39 and K40)	A.23/A.24
A.12	Transmitter Control Wiring (1A12) Change for Installation of LRE/AN/FPN-44	A.25/A.26
A.13	LRE/AN/FPN-44 Antenna Coupler Wiring Diagram	A.27/A.28
A.14	AN/FPN-44 Local Control Unit (CD 5)	A.29/A.30
A.15	Screen Room Junction Box	A.31/A.32

LIST OF TABLES

Table		Page
CHAPTER 1. GENERAL INFORMATION		
1.1	Electrical Power Requirements	1.8
1.2	Equipment Supplied	1.9
1.3	Equipment Required But Not Supplied	1.10
1.4	List of Abbreviations	1.13/1.14
CHAPTER 2. INSTALLATION		
2.1	Materials Supplied	2.1
2.2	Materials Required But Not Supplied	2.2
2.3	TCS Units Cable Interconnect List	2.3
2.4	EPA-Chart Recorder Wiring	2.6
2.5	W0678-18C/ECD Module Programming	2.8
2.6	TCS Input Signals	2.35
2.7	TCS Output Signals	2.36
CHAPTER 5. MAINTENANCE		
5.1	TCC Power Supply Voltage Limits	5.38
CHAPTER 6. PARTS LIST		
6.1	TCS, Reference Designations	6.1
6.2	Parts List	6.2
6.3	Table of Manufacturers	6.10



CHAPTER 1

GENERAL INFORMATION

1.1 Introduction. This technical manual provides a description of the various units of the AN/FPN-60(V) and AN/FPN-60A(V) Transmitter Control Sets (TCS). The TCS is installed at Loran-C Transmitting Stations which have the AN/FPN-44A or 45B Loran-C Transmitter installed. The TCS generates the drive waveforms for the transmitters and monitors the transmitter status and parameters of the transmitted signal. The TCS also provides an interface between the transmitter and the timing and control equipment. Figures 1.1 and 1.2 show the equipment for a dual-rate and single-rate configuration, respectively. Figure 7.1 is the Loran-C System Block Diagram. Appendix A contains diagrams of changes that have been made to the various transmitters and have not been placed in the transmitter technical manuals. Appendix B contains information on the ROS modified equipment in the AN/FPN-60A(V) TCS.

1.1.1 The following units of the AN/FPN-60(V) and AN/FPN-60A(V) are covered in this manual:

- a. 1 -Electrical Equipment Cabinet (CY-7523/FPN-60(V))
- b. 1A1-Switch Assembly (SA-2063/FPN-60(V))
- c. 1A1-Switch Assembly (SA-2063/FPN-60A(V))
(AN/FPN-60A(V) only)
- d. 1A2-Transmitter Coupler Control (C-9888/FPN-60(V))
- e. 1A3-Electrical Pulse Analyzer (TS-3550/FPN)
- f. 1A4-Pulse Generator No. 1 (Low Rate) (SG-1099/FPN-60(V))
- g. 1A5-Pulse Generator No. 1 (High Rate) (SG-1099/FPN-60(V))
(installed at dual-rated stations only)
- h. 1A6-Pulse Generator No. 2 (Low Rate) (SG-1099/FPN-60(V))
- i. 1A7-Pulse Generator No. 2 (High Rate) (SG-1099/FPN-60(V))
(installed at dual-rated stations only)
- j. 1A8-Waveform Panel (SB-4156/FPN-60)
- k. 1A9-Interface Unit (J-3353/FPN-60(V))
- l. 1A9-Interface Unit (J-3353/FPN-60A(V))
(AN/FPN-60A(V) only)
- m. 1A10-EPA Dummy Load Junction Box
- n. 1A11-TCC Dummy Load Junction Box

1.2 General Description.

1.2.1 The Transmitter Control Set (Figures 1.1 and 1.2) performs the following functions:

- a. Generates the drive waveforms for the transmitters.

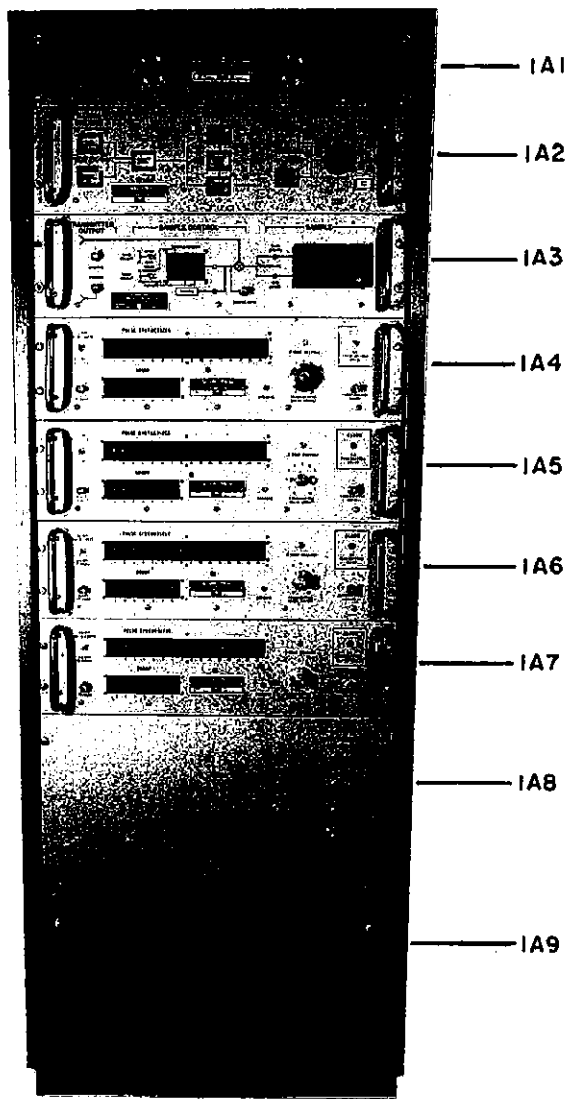


Figure 1.1. AN/FPN-60(V)2 Transmitter Control Set
(Dual-Rate Configuration)

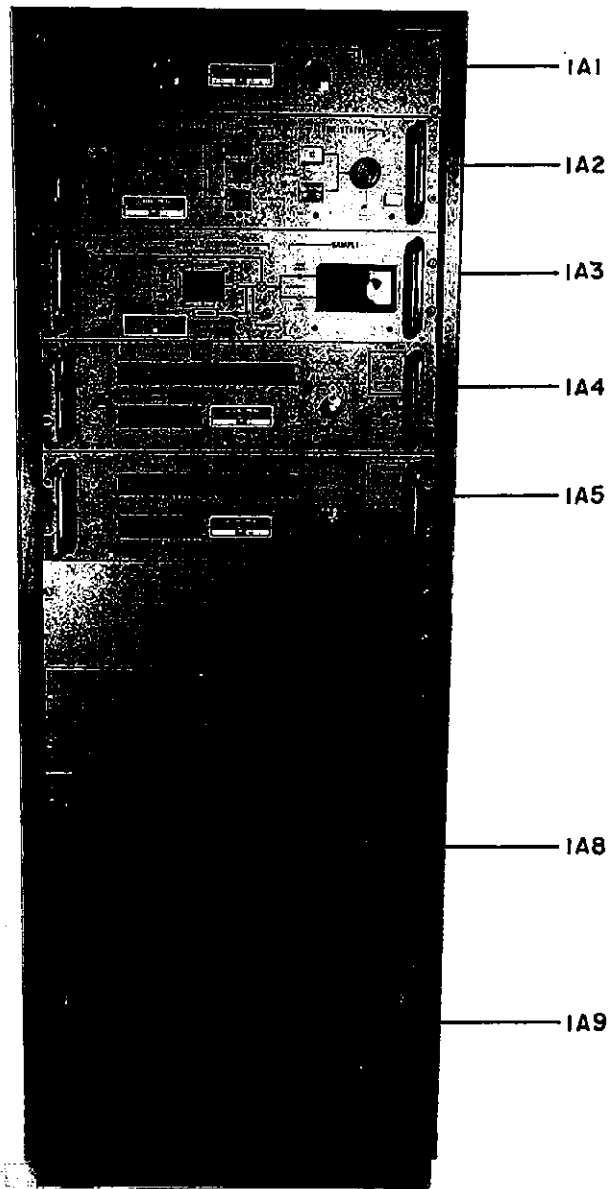


Figure 1.2. AN/FPN-60(V)1 Transmitter Control Set
(Single-rate configuration)

- b. Monitors the transmitted signal level.
- c. Provides the interface between the AN/FPN-54A Loran-Timing Set(s) and the transmitters.
- d. Provides a measurement of the radiated Loran-C pulse shape and amplitude.
- e. Measures and displays the Envelope-to-Cycle-Difference (ECD).
- f. Provides a means for remotely stopping the transmitters.
- g. Indicates the status of both transmitters.
- h. Automatically initiates a switch to the standby transmitter if the signal radiated by the operate transmitter drops below a preset level.
- i. Provides a means for external monitoring of the Loran-C signal.

1.3 Unit Description.

1.3.1 Switch Assembly (1A1). The Switch Assembly (Figure 1.3) contains an emergency stop pushbutton for each transmitter. These switches provide for the shutdown of power to the transmitters to prevent injury to personnel or damage to equipment. These switches are connected in series with the transmitter stop and emergency stop switches in the associated transmitting equipment (refer to the applicable transmitting set technical manual for locations).

1.3.1.1 Switch Assembly (1A1). SA-2063/FPN-60A(V) is a modified switch assembly to be used at ROS equipped stations. The switch assembly is modified to allow both vacuum tube transmitters to be de-energized remotely and simultaneously.

1.3.1.2 AN/FPN-44A/44B/45B Loran-C Transmitters.

WARNING

HAZARDOUS VOLTAGES ARE STILL PRESENT IN THE AN/FPN-44B/44A/45B TRANSMITTERS, AFTER THE ACTIVATION OF THE SWITCH.

When the emergency stop pushbutton is depressed, the transmitter shuts down, with the exception of the blowers and primary cooling, which are on a time delay circuit. This is done to insure that the power amplifier (PA) vacuum tubes are cooled down properly.

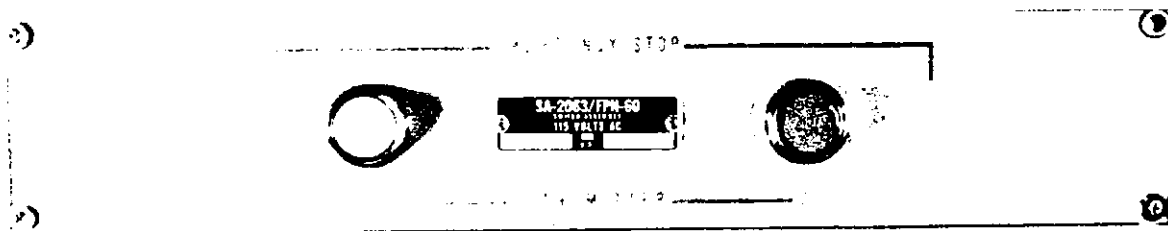


Figure 1.3. 1A1-Switch Assembly (SA-2063/FPN-60)

1.3.2 Transmitter Coupler Control (1A2). The Transmitter Coupler Control (Figure 1.4) contains the Transmitter Control Module W0678-5/XMTR CON, Relay Assembly W0678-13, and Transmitter Control Driver W0678-6/XMTR CON DVR. The Transmitter Coupler Control (TCC) performs the following functions:

- a. Monitors the status of the transmitters, pulse generators, and antenna coupler.
- b. Switches transmitters automatically upon a transmitter failure.
- c. Permits the manual switching of transmitters remotely.
- d. Displays transmitter local/remote control mode.
- e. Displays TRANSMITTER 1 and 2 status (OPERATE or STANDBY).
- f. Enables the STANDBY TRANSMITTER to operate into dummy load.

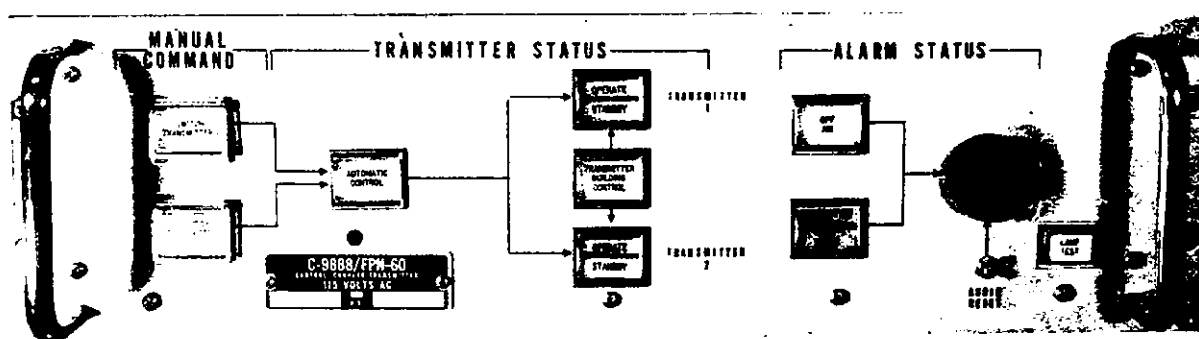


Figure 1.4. 1A2-Transmitter Coupler Control (C-9886/FPN-60)

1.3.3 Electrical Pulse Analyzer (1A3). The Electrical Pulse Analyzer (Figure 1.5) contains a Gate Control Module W0678-3A/GATCON, an Envelope-to-Cycle-Difference Module W0678-18C/ECD, a Peak Detector Module W0678-4/PK DET, and a Clip Attenuator Module W0678-11A/CLP

ATTN. The Electrical Pulse Analyzer (EPA) performs the following functions:

- a. Generates a Reference Envelope Waveform.
- b. Measures and displays the peak value of a selected half-cycle of a selected pulse or the peak amplitude of a LORAN-C pulse within a pulse group. The Electrical Pulse Analyzer can perform this function for either rate at a dual-rated station.
- c. Displays a measure of ECD.
- d. Generates the Local Envelope Crossover trigger.

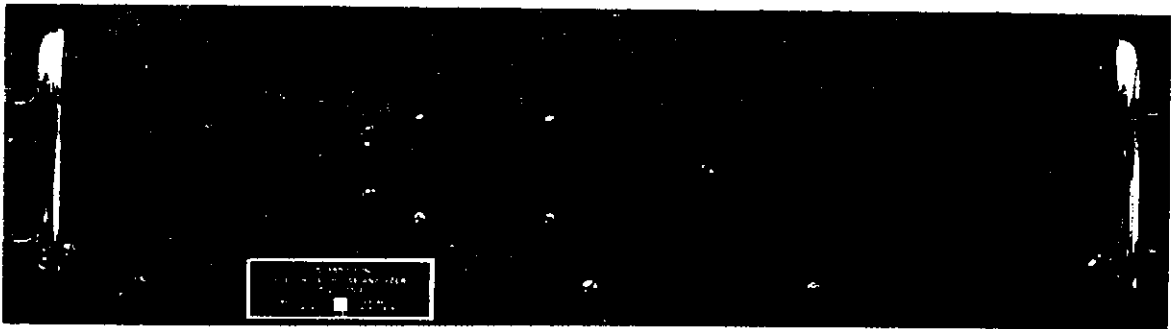


Figure 1.5. 1A3-Electrical Pulse Analyzer (TS-3550/FPN)

1.3.4 Pulse Generator (1A4-1A7). A dual-rated station has Pulse Generators 1A4 thru 1A7 (see Figure 1.1). A single-rated station has Pulse Generators 1A4 and 1A6 (see Figure 1.2). The Pulse Generator (Figure 1.6) contains the Pulse Control Module W0678-2/PCON, Group Droop Module W0678-19B/GR DROOP (for dual-rated stations and stations having tail drive), and Pulse Synthesizer Module W0678-1/PSYN. The Group Droop Module W0678-20/GR DROOP is unique to LORAN STATION CAPE RACE, replacing the W0678-19B/GR DROOP module. The Pulse Generator (PGEN) performs the following functions:

- a. Generates a transmitter drive signal of adjustable shape.
- b. Provides for phase code balance adjustments.
- c. Generates an oscilloscope trigger signal.
- d. Provides the capability of selecting either 1st MPT (NON-Ø CODED) or 2nd MPT (Ø CODED) for the SCOPE TRIGGER.
- e. Provides for transmitted signal droop compensation.
- f. Provides control of the transmitter drive signal amplitude.
- g. Provides visual alarm and logic level output when transmitter drive is below a set level.

h. For dual-rated stations, provides dynamic droop compensation of the transmitter drive signal.



Figure 1.6. 1A4-1A7 - Pulse Generator (SG-1099/FPN-60(V))

1.3.5 Waveform Panel (1A8). The Waveform Panel (Figure 1.7) has two inputs, ENV TRIG+ and ENV TRIG-. It also provides a convenient access to the following signals:

- a. Full wave rectified version of the Loran-C signal.
- b. Reference Loran-C signal envelope.
- c. Oscilloscope trigger (select operate high or low rate).
- d. Optional waveform jack.

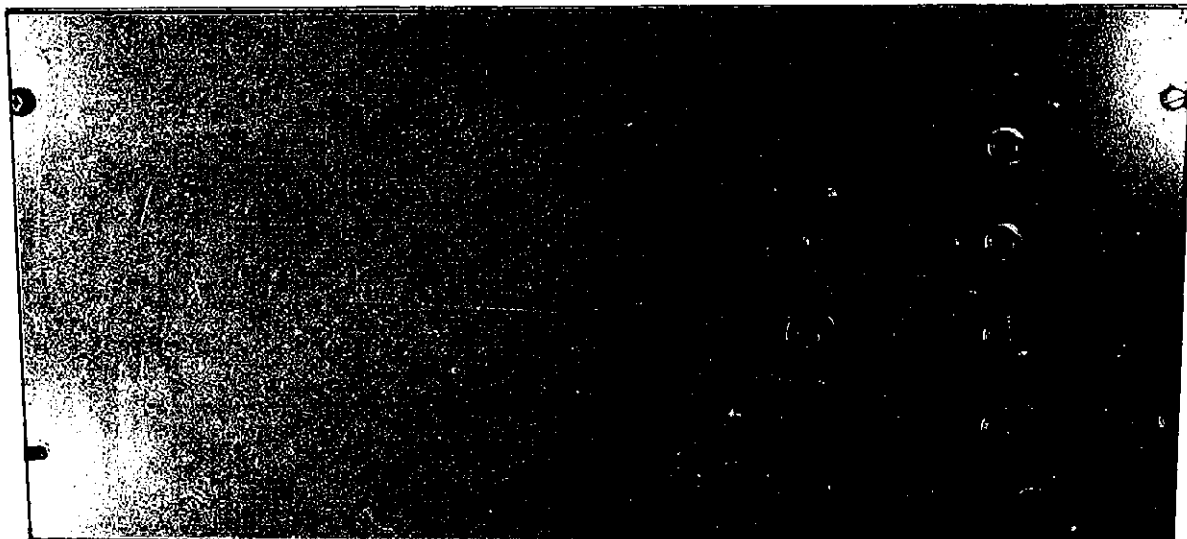


Figure 1.7. 1A8-Waveform Panel (SB-4156/FPN-60(V))

1.3.6 Interface Unit (1A9). The Interface Unit (Figure 1.8) is the unit through which all signals among the AN/FPN-54A Loran Timing Set and the Pulse Generators (PGENs) are routed. In addition, all signals among the units of the Transmitter Control Set (except those of the Waveform Panel) are routed to this unit. The Interface Unit also performs impedance matching, muticoupling, and signal isolation.

1.3.6.1 Interface Unit (1A9). The J-3353/FPN-60A(V) is a modified Interface Unit to be used at ROS equipped stations.

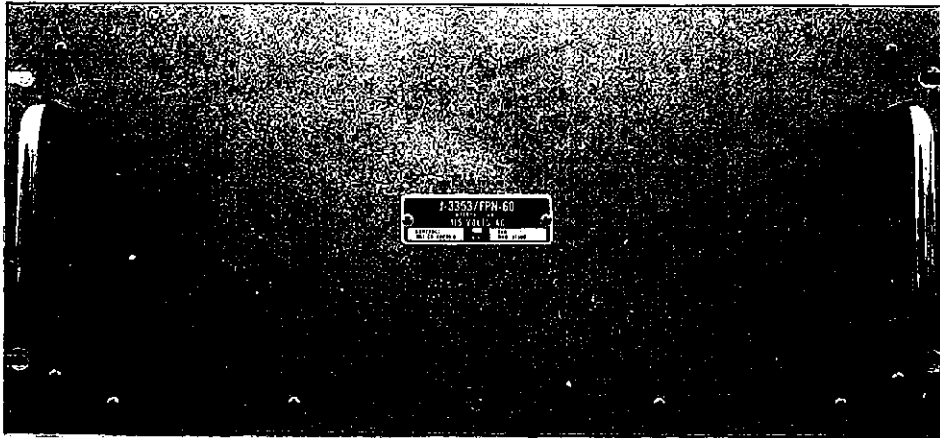


Figure 1.8. 1A9-Interface Unit (J-3353/FPN-60(V))

1.3.7 EPA Dummy Load Junction Box (1A10). The EPA Dummy Load Junction Box is used when the EPA is removed from the equipment cabinet.

1.3.8 TCC Dummy Load Junction Box (1A11). The TCC Dummy Load Junction Box is used when the TCC is removed from the equipment cabinet.

1.4 Reference Data. Table 1.1 lists the electrical power requirements of several units of the Transmitter Control Set. Tables 1.2 and 1.3 list the equipment supplied and the equipment required but not supplied, respectively. Figure 1.9 shows the relationships of all the units of the Transmitter Control Set.

Table 1.1. Electrical Power Requirements

NAME/DESIGNATION	INPUT POWER
Transmitter Coupler Control C-9888/FPN-60(V)	115 VAC $\pm 10\%$ 50-60 Hz, 22 W
Electrical Pulse Analyzer TS-3550/FPN	115 VAC $\pm 10\%$ 50-60 Hz, 31 W
Pulse Generator SG-1099/FPN-60(V)	115 VAC $\pm 10\%$ 50-60 Hz, 28 W

Table 1.2. Equipment Supplied

QUANTITY PER EQUIPMENT	NOMENCLATURE		OVERALL DIMENSIONS				VOLUME	WEIGHT
	NAME	DESIGNATION	HEIGHT	WIDTH	DEPTH			
1 NOTE A	Switch Assembly	SA-2063/FPN-60(V)	3.5 in 9 cm	19.0 in 48 cm	2.0 in 5 cm	.08 ft3 2192 cm3	1.5 lbs .7 kg	
1	Transmitter Coupler Control	C-9888/FPN-60(V)	5.25 13	19.0 48	17.0 43	.98 27751	21.0 9.5	
1	Electrical Pulse Analyzer	TS-3550/FPN	5.25 13	19.0 48	20.75 53	1.19 33854	28.0 12.7	
NOTE B	Pulse Generator	SG-1099/FPN-60(V)	5.25 13	19.0 48	17.0 43	.98 27751	17.0 7.7	
1	Waveform Panel	SB-4156/FPN-60(V)	8.75 22	19.0 48	1.0 3	.1 2681	2.5 1.1	
1 NOTE C	Interface Unit	J-3353/FPN-60(V)	8.75 22	19.0 48	10.0 25.4	.96 27235	11.5 5.2	
NOTE D	Blank Panel		10.5 27	19.0 48	-- --	-- --	-- --	
1	Electrical Equipment Cabinet	CY-7523/FPN-60(V)	59.5 151	21.875 56	31.125 79	23.4 668024	170.0 77.2	

- NOTES: A. The SA-2063/FPN-60A(V) Switch Assembly is used in AN/FPN-60A(V) Transmitter Control Sets.
 B. Four for dual-rated stations; Two for single-rated stations.
 C. The J-3353/FPN-60A(V) Interface Unit is used in AN/FPN-60A(V) Transmitter Control Sets.
 D. One for single-rated stations, only.

Table 1.3. Equipment Required But Not Supplied

QUANTITY PER EQUIPMENT	NOMENCLATURE		REQUIRED USE	REQUIRED CHARACTERISTICS
	NAME	DESIGNATION		
1	Status Alarm Unit	BZ-265/FSN-2(V)	Displays TCS Alarm Data	
NOTE A	Time Interval Counter Panel	SB-4266/FSN-2(V)	Sets ECD Limits	
1	Remote Control Group Technical Manual			
NOTE B	Timer Set	AN/FPN-54A	Generates Timing and Phase Code Signals	MPT, PCI, and LI
2	LORAN-C Transmitter	NOTE C		
1	Oscilloscope	AN/USM-281 or Equivalent	Installation Alignment and Testing	50 MHz, BW; 10 mV Sensitivity; Delayed Sweep; Delayed Gate Output
1	Multimeter	CCUH-8000A or Equivalent	Installation Alignment and Testing	50 VDC; 150 VAC; 5 Amp (DC); 200 to 2 M

NOTES: A. Quantity dependent upon number of rates and responsibilities.
 B. Two for dual-rated stations; One for single-rated stations.
 C. AN/FPN-44A/44B or 45B.

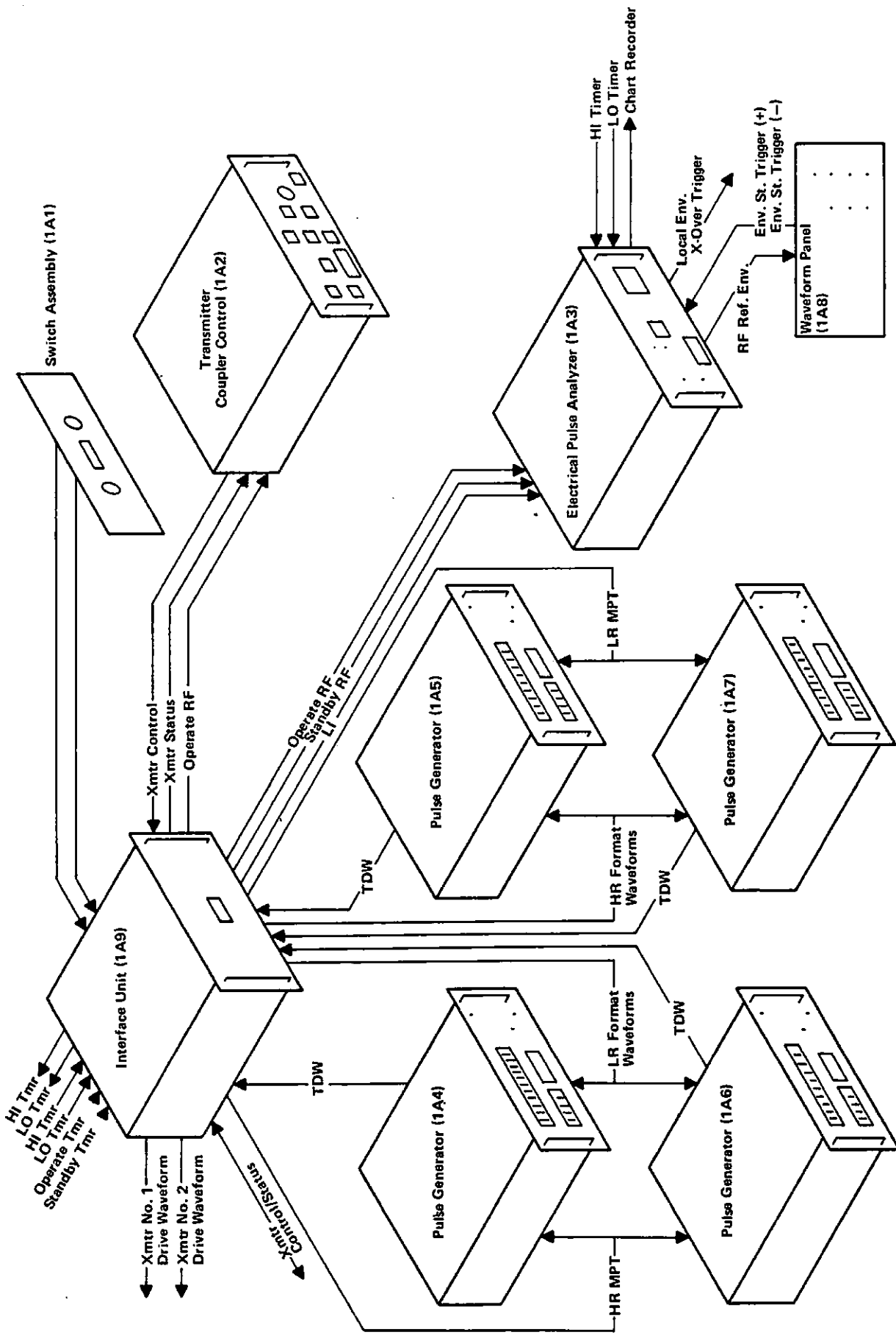


Figure 1.9. Interrelationship Of TCS Units

1.5 Inquiries. For logistics support, Supply Center Brooklyn is the Inventory Control Point (ICP). Refer to E/GICPINST 4408.1 (series) for XB stock number assistance. For logistic assistance, contact Customer Services Branch at Supply Center, Brooklyn, NY.

NOTE

For the latest version of the E/GICPINST 4408.1 (series) instruction, contact:

Commanding Officer (Code 340)
U.S. Coast Guard Supply Center
830 Third Avenue
Brooklyn, NY 11232

1.6 Abbreviations. The abbreviations used throughout this manual are listed and defined in Table 1.4.

1.7 Safety Precautions.

1.7.1 Reference Publications. The following is a list of publications that all technical personnel must be familiar with:

- a. M10550.13 - Electronics Manual
- b. M10550.14 - Electronics Manual
- c. M10550.15 - Electronics Manual
- d. M5100.29 - Safety Manual
- e. M11000.1 - Civil Engineering Manual
- f. CG-139 - Cardiopulmonary Resuscitation Handbook
- g. CG-516 - First Aid Health Lesson Plan

1.7.2 Notes, Warnings, and Cautions.

NOTE

READ ALL They are used in narrative or illustrative non-procedural data.

WARNING

READ ALL

THEY DISCLOSE HAZARDS WHICH MAY CAUSE
BODILY INJURY OR DEATH!

CAUTION

READ ALL

THEY REVEAL INFORMATION WHICH MAY
DAMAGE OR DESTROY EQUIPMENT!

Table 1.4. List of Abbreviations

CODE	DEFINITION	CODE	DEFINITION
AM	AMPLITUDE MODULATED	PC	PHASE CODE
CCW	COUNTER CLOCKWISE	PC RESET	PHASE CODE RESET
CLP ATTN	CLIP ATTENUATOR	PC SET	PHASE CODE SET
DPM	DIGITAL PANEL METER	PCI	PHASE CODE INTERVAL
DR	DUAL RATE	PCON	PULSE CONTROL
DVM	DIGITAL VOLT METER	PGEN	PULSE GENERATOR
ECD	ENVELOPE-TO-CYCLE-DIFFERENCE	PK DET	PEAK DETECTOR
EMPT	EARLY MULTIPULSE TRIGGER	PSYN	PULSE SYNTHESIZER
EOC	END OF CONVERSION (A LOGIC SIGNAL GENERATED IN THE DIGITAL PANEL METER OF THE ELECTRICAL PULSE ANALYZER)	RCG	REMOTE CONTROL GROUP
EPA	ELECTRICAL PULSE ANALYZER	RCI	REMOTE CONTROL INTERFACE
ET	EARLY TRIGGER	RF	RADIO FREQUENCY
ETA	ENVELOPE TIMING ADJUSTMENT	SA	SWITCH ASSEMBLY
FWR	FULL WAVE RECTIFIED	SMEF	SYSTEM MAINTENANCE ENGINEERING FACILITY
GATCON	GATE CONTROL	STBY, STDBY	STANDBY
GR DROOP	GROUP DROOP	SYNC	SYNCHRONOUS NUMBER
GRI	GROUP REPETITION INTERVAL	TBC	TRANSMITTER BUILDING CONTROL
GRR	GROUP REPETITION RATE	TCC	TRANSMITTER COUPLER CONTROL
HR	HIGH RATE	TCE	TIMING AND CONTROL EQUIPMENT
IAW	IN ACCORDANCE WITH	TCS	TRANSMITTER CONTROL SET
ICP	INVENTORY CONTROL POINT	TDW	TRANSMITTER DRIVE WAVEFORM
I/F	INTERFACE	TIC	TIME INTERVAL COUNTER
LED	LIGHT EMITTING DIODE	TINO	TIME INTERVAL NUMBER
LEN	LOCAL ENVELOPE NUMBER	TMR	TIMER
LI	LOCAL INTERVAL	TP	TEST POINT
LPA	LOCAL PHASE ADJUSTMENT	TTL	TRANSISTOR TRANSISTOR LOGIC
LR	LOW RATE	TTY	TELETYPE
LRE	LORAN REPLACEMENT EQUIPMENT	VPK	PEAK VALUE OF VOLTAGE
LSB	LEAST SIGNIFICANT BIT	W	WATTS
MPT	MULTIPULSE TRIGGER	WF	WAVEFORM
MSB	MOST SIGNIFICANT BIT	WP	WAVEFORM PANEL
MTBF	MEAN TIME BETWEEN FAILURE	XMTR	TRANSMITTER
OOT	OUT OF TOLERANCE	XMTR CON	TRANSMITTER CONTROL
OP	OPERATE	XMTR CON DVR	TRANSMITTER CONTROL DRIVER
		100 kHz	NON-PHASE CODED 100 kHz SINEWAVE



CHAPTER 2
INSTALLATION

2.1 Introduction. This chapter provides procedures for unpacking and inspecting the Transmitter Control Set equipment. It describes procedures for installing, programming, adjusting, and initially operating each unit of the TCS. There are also procedures for the de-installation and shipment of equipment.

2.2 Unpacking and Initial Inspection.

2.2.1 Inspect the shipping containers for external damage. If the containers are damaged, have the carrier's agent present when the containers are unpacked.

2.2.2 After unpacking the containers, inspect the chassis and modules for mechanical damage. Inspect all electrical wiring and connections to ensure that connections have not been damaged. Inspect for damage and note any scratches, dents, broken knobs, or broken wires on the units, including cables (see Table 2:1).

Table 2.1. Materials Supplied

QUANTITY PER EQUIPMENT	NOMENCLATURE		OVERALL DIMENSIONS			VOLUME	WEIGHT
	NAME	DESIGNATION	LENGTH	WIDTH	DEPTH		
36	Mounting Screws	10-32	.5 in. 1.3 cm.				
36	Captive Nuts	10-32					
2	Two conductor cables	Alpha 1897	114 in. 289 cm.				
Note A	Interconnect Cable	WO678-7	78 in. 198 cm.				
1	Interconnect Cable (PA)	WO678-8	.78 in. 198 cm.				
1	Interconnect Cable (AC)	WO678-9	78 in. 198 cm.				
1	Copper Strap		55 in. 139 cm.	1.0 in. 2.5 cm.	.0625 in. .16 cm.		

NOTE A: Six for Dual-Rated stations.
Four for Single-Rated stations.

2.3 Installation Instructions.

2.3.1 Materials. Table 2.1 lists the materials that are supplied. Table 2.2 lists the materials that are required, but not supplied. Table 2.3 is a cable interconnect list between the TCS units. For more information on cables listed in Table 2.3 see Figure 7.3.

Table 2.2. Materials Required But Not Supplied

QUANTITY PER EQUIPMENT	NOMENCLATURE		REQUIRED USE	REQUIRED CHARACTERISTICS
	NAME	DESIGNATION		
4	Coaxial Cables	RG-58C/U	Connect EPA to WP	Length 4 feet
8	Connectors	UG-88/U	For Cables used between EPA and WP	BNC
NOTE A	Twinaxial Cables	RG-22B/U	Connect PGEN's to I/F	Length 4 feet
NOTE B	Connectors	UG-421B/U	For PGEN's to I/F Cables	Polarized Twinax
1	AC Power Cable(Note C)	ALPHA 1937	Connect Electrical Power from Circuit Breaker to to Cabinet	12-2

NOTES: A. Four each for Dual-Rated Stations.
Two each for Single-Rated Stations.

B. Eight each for Dual-Rated Stations.
Four each for Single-Rated Stations.

C. Length as required to meet Station Equipment Location.

2.3.2 Electrical Equipment Cabinet.

2.3.2.1 The location of the TCS equipment cabinet is to the right of the AN/FPN-54A Loran Timing Set (as viewed from the front). Locations of the individual units are as shown in Figure 1.1 or Figure 1.2.

WARNING

Ensure that the circuit breaker designated for this cabinet is OFF and tagged.

Table 2.3. TCS Units Cable Interconnect List

FROM	CABLE CONNECTOR	CABLE	CABLE CONNECTOR	TO
SA (S1) *	#22-16 Lugs	Alpha 1897	#22-16 Lugs	I/F (TB1-1, TB1-6)
SA (S2) *	#22-16 Lugs	Alpha 1897	#22-16 Lugs	I/F (TB2-2, TB2-6)
TCC (J1) *	Multiconductor Cable ALPHA #6025			I/F (J23)
TCC (J2) *	W0678-9/AC Interconnect Cable			
	Multiconductor Cable ALPHA #6016			
EPA (J4)	BNC UG-88/U	RG-58 C/U	BNC UG-88/U	WP (J1)
EPA (J5)	BNC UG-88/U	RG-58 C/U	BNC UG-88/U	WP (J4)
EPA (J6) *	Multiconductor Cable ALPHA #6016			I/F (J22)
EPA (J7) *	W0678-7/Interconnect Cable			I/F (J20)
EPA (J8)	BNC UG-88/U	RG-58 C/U	BNC UG-88/U	WP (J3)
EPA (J9)	BNC UG-88/U	RG-58 C/U	BNC UG-88/U	WP (J2)
PGEN (J5) *	Polarized Twinax UG-421 B/U	RG-22 B/U	Polarized Twinax UG-421 B/U	I/F (J31)
PGEN (J7) *	Multiconductor Cable ALPHA #6016			I/F (J15)
PGEN (J5) *	Polarized Twinax UG-421 B/U	RG-22 B/U	Polarized Twinax UG-421 B/U	I/F (J33)
PGEN (J7) *	Multiconductor Cable ALPHA #6016			I/F (J17)
PGEN (J5) **	Polarized Twinax UG-421 B/U	RG-22 B/U	Polarized Twinax UG-421 B/U	I/F (J27)
PGEN (J7) **	Multiconductor Cable ALPHA #6016			I/F (J18)
PGEN (J5) **	Polarized Twinax UG-421 B/U	RG-22 B/U	Polarized Twinax UG-421 B/U	I/F (J29)
PGEN (J7) **	Multiconductor Cable ALPHA #6016			I/F (J16)

* These cables are supplied.

** These cables are supplied for dual-rated stations.

2.3.2.2 Ground the cabinet to the timer room grounding system (see Figure 2.1 for the overhead ducting scheme). Local connection with the system is made with silver solder and pigtail connections at either the overhead or below floor ducting. Additional grounding information may be found in COMDTINST M10550.15.

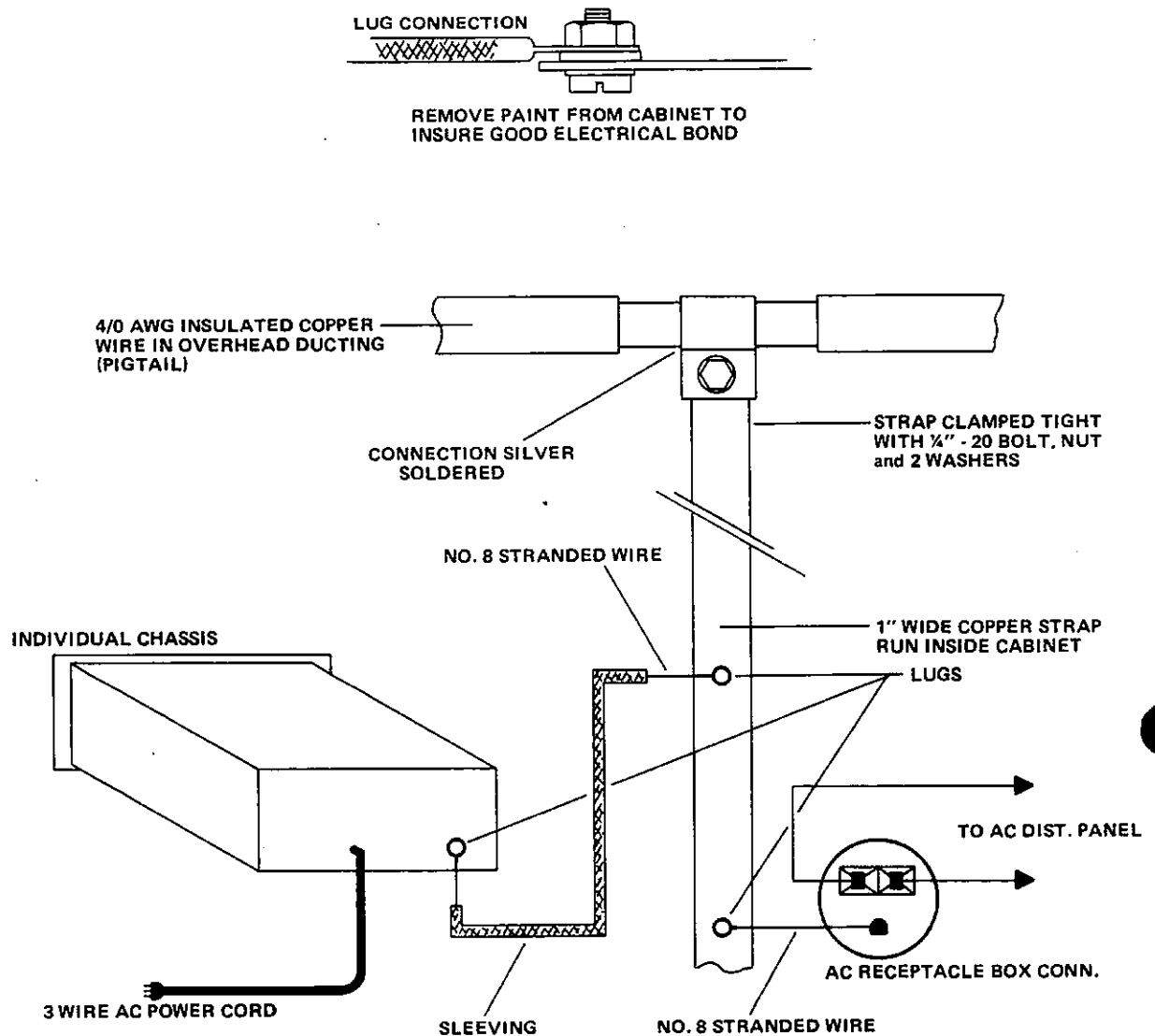


Figure 2.1. Chassis and Cabinet Grounding Details for Overhead Ducting

CAUTION

The Electrical Equipment Cabinet is on a separate circuit breaker, located inside the timer room. DO NOT energize the cabinet, until after the installation of all units. All units are energized upon the application of power.

2.3.2.3 Connect the AC line power cable from the power distribution panel (ensure that the circuit breaker is off) to the cabinet terminal block 1TB1 via the duct at the top of the cabinet. The terminal block supplies power to an AC outlet strip, located inside the cabinet.

2.3.2.4 Figure 2.2 is an illustration of the Electrical Equipment Cabinet. The Electrical Equipment Cabinet is a standard item that has been modified for Coast Guard use.

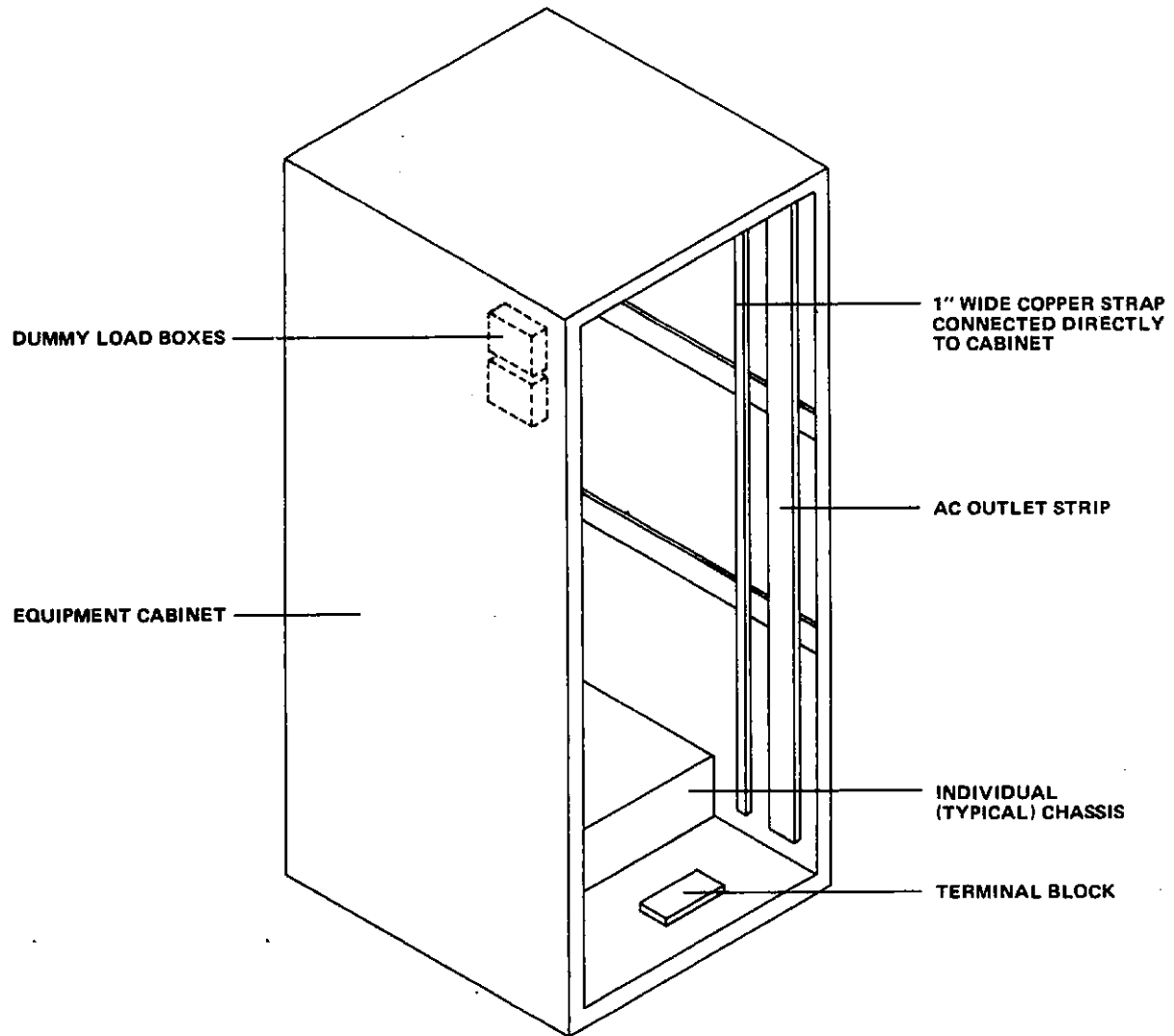


Figure 2.2. Electrical Equipment Cabinet (Rear View)

NOTE

The station's drawings contain the types of cables used between the TCS and other equipments. This manual contains cable specifications of the cables interconnecting the units of the TCS. All of the wiring/cabling in this chapter is for dual-rated stations. Single-rated stations will make connections to "low rate" or "rate 1" only.

2.3.3 Switch Assembly

2.3.3.1 Mount the Switch Assembly (SA) in the cabinet (see Figure 1.1) using four 10-32 mounting screws and captive nuts.

2.3.3.2 Refer to Table 2.3 and Figure 7.3 to connect the Switch Assembly to the Interface Unit.

2.3.4 Transmitter Coupler Control

2.3.4.1 Mount the Transmitter Coupler Control (TCC) in the cabinet (see Figure 1.1) using four 10-32 mounting screws and captive nuts.

2.3.5 Electrical Pulse Analyzer

2.3.5.1 Mount the Electrical Pulse Analyzer (EPA) in the cabinet (see Figure 1.1) using four 10-32 mounting screws and captive nuts.

2.3.5.2 Set the FRONT PANEL CONTROL/REMOTE CONTROL switch (S5), located on the rear of the EPA (Figure 2.3), to the FRONT PANEL CONTROL position.

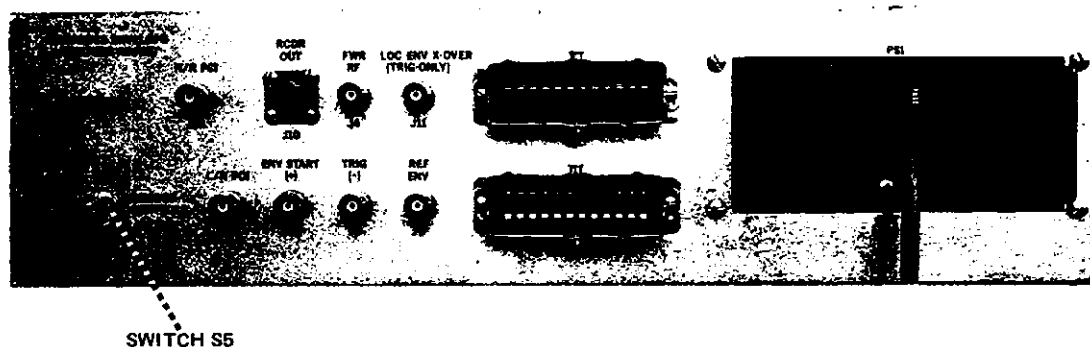


Figure 2.3. EPA Rear Panel Location of Switch S5

2.3.5.3 Connect the coaxial cables in accordance with Figure 7.4.

2.3.5.4 Connect a two conductor, shielded cable from a chart recorder (refer to the Remote Control Group technical manual) to J10 on the EPA (see Figure 7.4). Table 2.4 shows the required connections to be made.

Table 2.4. EPA-Chart Recorder Wiring

To Connect From J10 to Recorder	Use Pins		
	A	B	C (shield)
For Current Drive (0-1 ma) $Z_{in} < 1500\Omega$	+	-	
For Voltage Drive (0-5 v) $Z_{in} \geq 50 K\Omega$		+	-

2.3.6 Pulse Generator

2.3.6.1 At dual-rated stations, mount the four Pulse Generators (PGNs) as shown in Figure 1.1, using sixteen 10-32 mounting screws and captive nuts.

2.3.6.2 At single-rate stations, mount the two PGENs in the 1A4 and 1A5 locations (see Figure 1.2) using eight 10-32 mounting screws and captive nuts. Mount the blank panel in the 1A6 and 1A7 locations.

2.3.7 waveform panel

2.3.7.1 Mount the Waveform Panel (WP) in the cabinet (see Figure 1.1) using four 10-32 mounting screws and captive nuts.

2.3.7.2 Connect the coaxial cables between the EPA and the Waveform Panel in accordance with Figure 7.3.

2.3.8 Interface Unit

2.3.8.1 Mount the Interface Unit (I/F) in the cabinet (see Figure 1.1 or Figure 1.2) using four 10-32 mounting screws and captive nuts.

2.3.8.2 Connect the coaxial cables between the Timer Control Unit and the Interface Unit in accordance with Figure 7.4.

2.3.8.3 Refer to Figure 2.4 for twin-axial connector polarity. This polarity configuration must be maintained to obtain correct signal distribution.

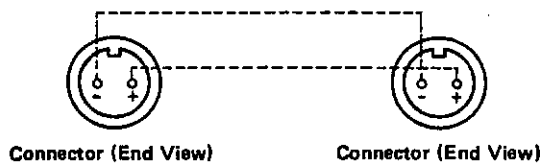


Figure 2.4. Twin-axial Polarity

2.3.8.4 Connect the twin-axial cables in accordance with Figures 7.3 and 7.4. If the station is single-rated make only the low rate connections.

2.3.8.5 Connect cables between the following pairs of jacks:

- a. J15 I/F to J7 PGEN (1A4) (W0678-7/Interconnect Cable).
- b. If dual-rated, J16 I/F to J7 PGEN (1A7) (W0678-7/Interconnect Cable).
- c. J17 I/F to J7 PGEN (1A6) (W0678-7/Interconnect Cable).
- d. If dual-rated, J18 I/F to J7 PGEN (1A5) (W0678-7/Interconnect Cable).
- e. J19 I/F to Status Alarm Unit (BZ-265/FSN-2(V)) TB3-12 thru TB3-18 (see Figure 7.4).
- f. J20 I/F to J6 EPA (W0678-7/Interconnect Cable).
- g. J21 I/F to J2 TCC (W0678-7/Interconnect Cable).
- h. J22 I/F to J7 EPA (W0678-8/PA Interconnect Cable).
- i. J23 I/F to J1 TCC (W0678-9/AC Interconnect Cable).

2.3.9 Ground all units to the copper strap in the cabinet, according to Figure 2.1.

2.3.10 Plug the ICC, EPA, and PGENS into the cabinet's AC power receptacles.

2.4 Installation Drawings. Figures 2.6-2.11 show the dimensions of the units of the TCS.

2.5 Adjusting and Programming.

2.5.1 Electrical Pulse Analyzer programming.

NOTE

To prevent transmitted signal timing shifts due to the cycle compensation loop in the operate timer when working on the EPA, connect a jumper from TP2 (Orange) to TP6 (Black) on the M Card of the operate timer. This disables the cycle compensation loop. If the station is dual-rated, connect a jumper from TP2 (Orange) to TP6 (Black) on the M Card of the operate timers of both rates. Remove the jumper(s) when done.

2.5.1.1 ECD module programming. Program both the operate W0678-18C/ECD module and the spare W0678-18C/ECD module according to Table 2.5.

Table 2.5. W0678-18C/ECD Module Programming

STATION CONFIGURATION	PROGRAMMING
Low Rate Master	Connect E3 to E5
High Rate Master	Connect E3 to E4
Low Rate Secondary	Do Not Connect E3 to E5
High Rate Secondary	Do Not Connect E3 to E4

2.5.1.2 Chassis programming. Program the EPA chassis according to Figure 2.5.

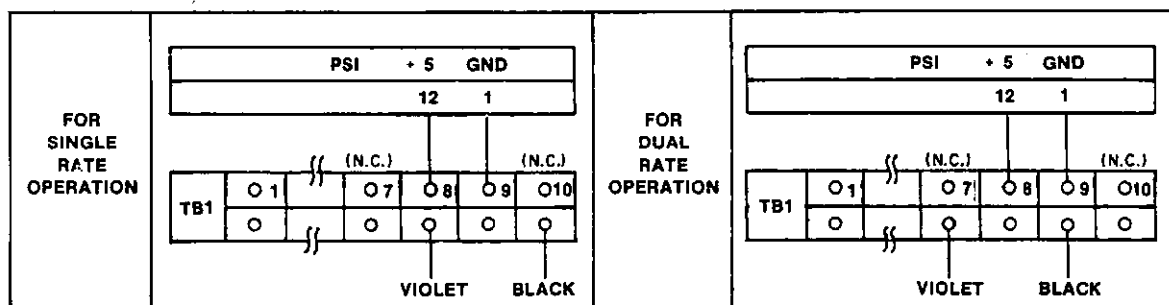


Figure 2.5. Pictorial of EPA Chassis Programming

2.5.2 Pulse Generator programming. Refer to Figure 7.31 for the backplane wiring differences between PGENS at various stations.

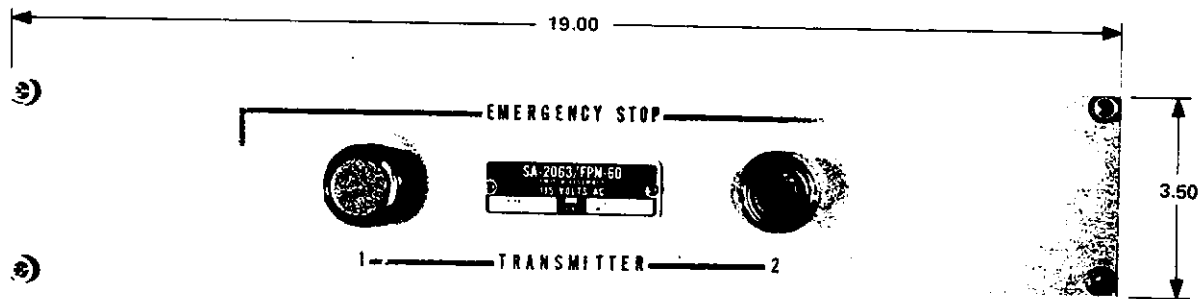


Figure 2.6. 1A1 Switch Assembly

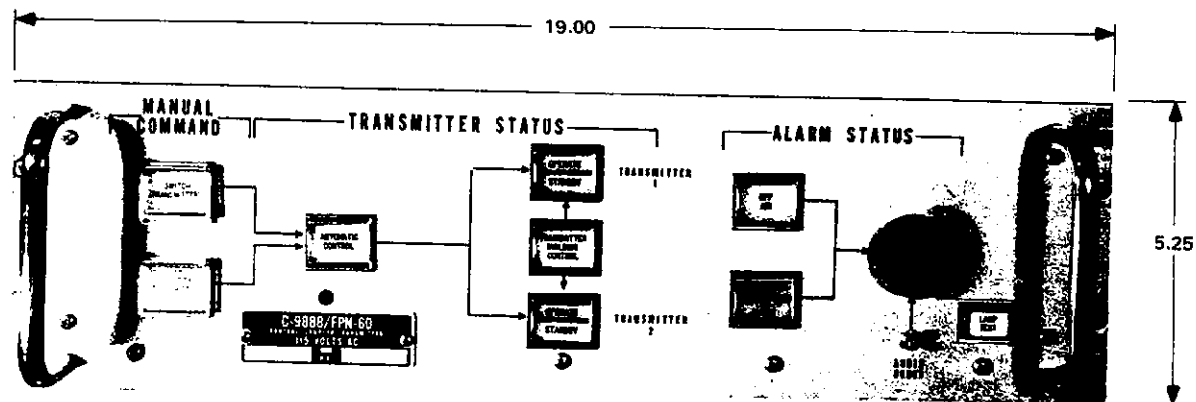


Figure 2.7. 1A2 Transmitter Coupler Control

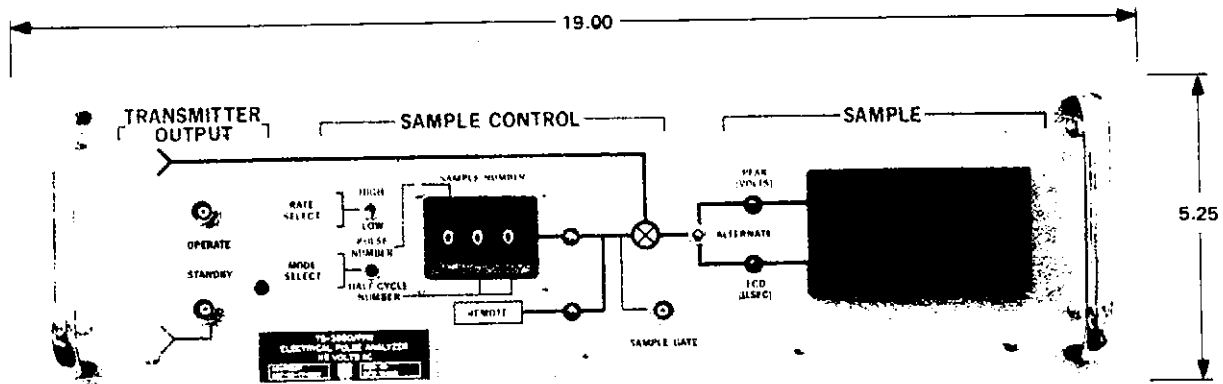


Figure 2.8. Electrical Pulse Analyzer

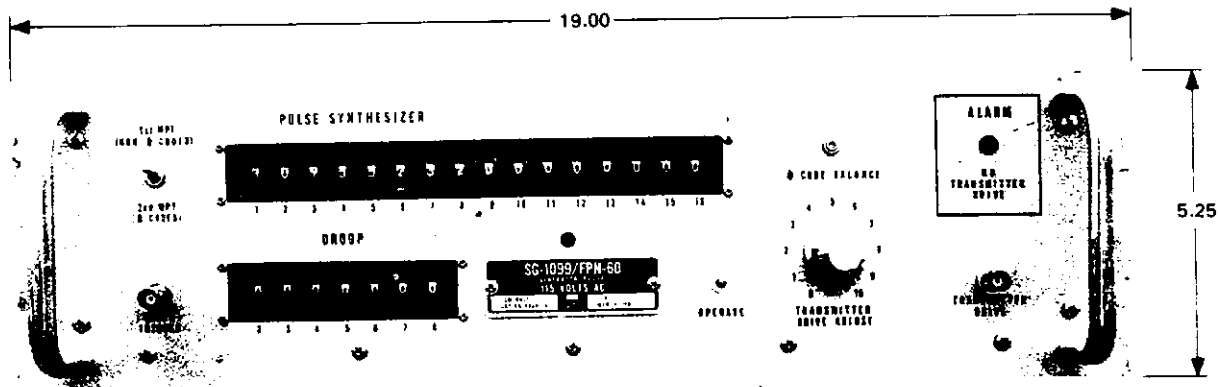


Figure 2.9. 1A4-1A7 Pulse Generator

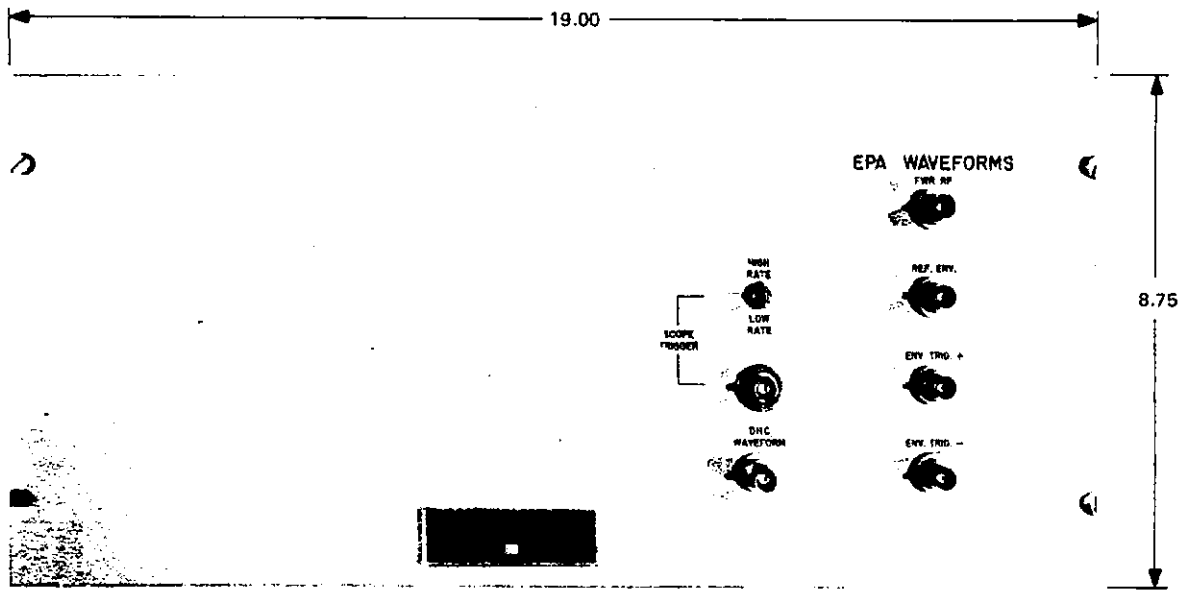


Figure 2.10. 1A8 Waveform Panel

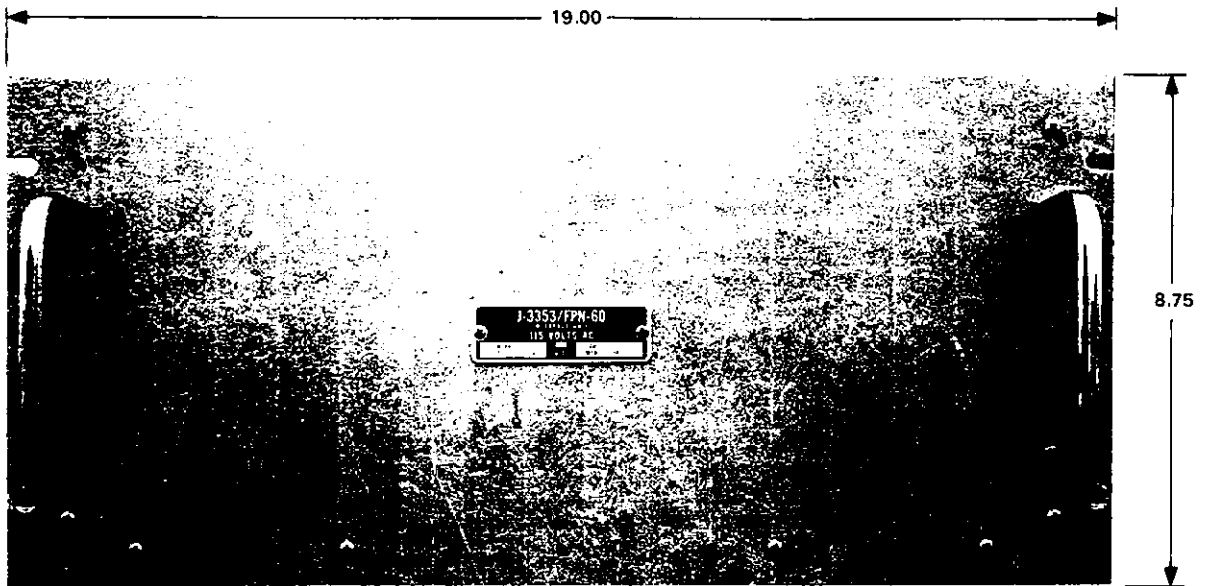


Figure 2.11. 1A9 Interface Unit

2.5.3 Group Droop Module Programming and Initial Settings. This procedure is required when replacing a Group Droop module as well as for initial installation. For test point and potentiometer locations refer to Figure 2.12.

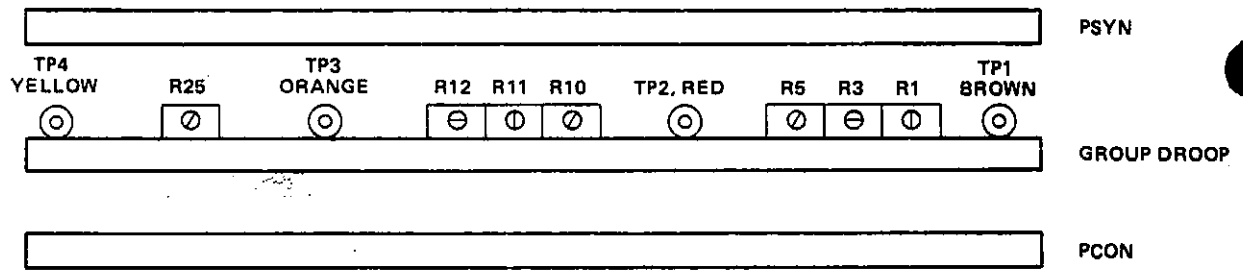


Figure 2.12. Test Point and Potentiometer Locations (as viewed with PGEN side panel removed)

NOTE

All jumpers are to be of #22 AWG solid wire.

a. W0678-19B/GR DROOP module for AN/FPN-44/44A/45 Transmitters.

(1) Jumper pin 1 to pin 14 and pin 5 to pin 16 on E2. Jumper pin 3 to pin 9 and pin 7 to pin 8 on E4. (See Figure 2.13.)

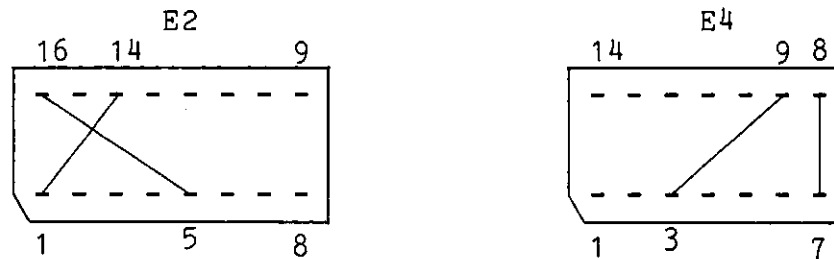


Figure 2.13. Programming of W0678-19B/GR DROOP Module Headers for AN/FPN-44/44A/45 Transmitters

(2) For stations not employing tail drive, if Q4 has not been removed, do so now. Insert a jumper between the source and drain of Q4, see Figures 2.14 and 7.34.

(3) For stations not employing tail drive, if C10 has not been removed, remove it.

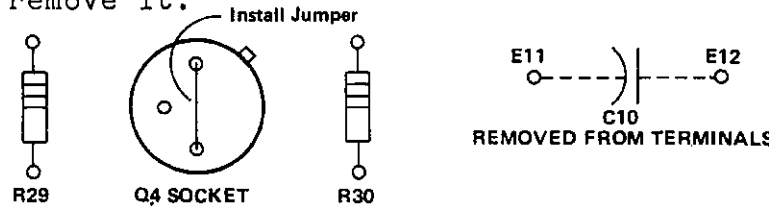


Figure 2.14. W0678-19B/GR/DROOP MODULE CHANGES

(4) Adjust R1 and R5 (see Figure 2.12) fully in the clockwise direction.

(5) Adjust R12 and R10 (see Figure 2.12) fully in the counterclockwise direction.

2.5.3.a. (6) R3, R11, and R25 require no adjustment.

(7) Install the module in the PGEN and set the PGEN DROOP thumbwheels to all zeroes (0's) and the TRANSMITTER DRIVE ADJUST to zero.

b. W0678-19B/GR DROOP module for AN/FPN-42 Transmitters.

(1) Jumper pin 5 to pin 9 and pin 7 to pin 8 on E4. Insert a jumper between pin 3 and pins 5, 14, and 16 on E2. (See Figure 2.15.) Insert a jumper between the source and drain pins of the Q4 socket and remove C10 (see Figures 2.14 and 7.34).

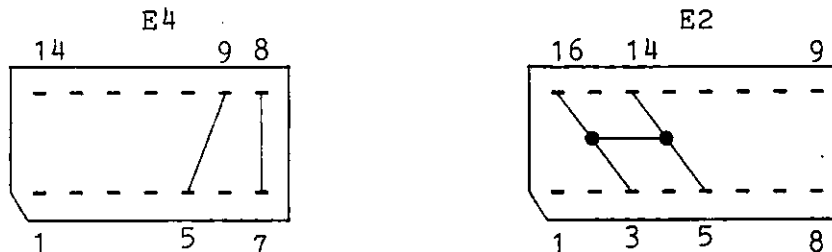


Figure 2.15. Programming of W0678-19B/GR DROOP Module Headers for AN/FPN-42 Transmitters

(2) Adjust R12 and R25 fully in the counterclockwise direction. Do not touch again.

c. For Tail Drive adjustment procedure for the W0678-19B/GR DROOP module for the AN/FPN-44/44A/45 Transmitters with feedback modification, see Paragraph 2.7.

d. Refer to local instructions to program the W0678-20/GR DROOP module for LORAN Station CAPE RACE.

e. A Group Droop module is not used with the AN/FPN-39 Transmitter.

2.6 Initial Operation.

2.6.1 Equipment turn-on. Energize the circuit breaker to the TCS Electrical Equipment Cabinet.

2.6.2 Power Supplies. Check the power supplies of all units according to:

Power Supply	Reference paragraph
TCC PS1	5.3.3.1.a
TCC PS2	5.3.3.1.b
EPA PS1	5.3.3.2.a
EPA PS2	5.3.3.2.a
PGEN PS1	5.3.3.3

2.6.3 Electrical Pulse Analyzer initial operation.

2.6.3.1 Set the front panel switches as follows:

- RATE SELECT switch to LOW.
- MODE SELECT switch to PULSE NUMBER position.
- PEAK (VOLTS)/ECD (usec) switch to ALTERNATE.

2.6.3.2 Turn the left hand thumbwheel (or PULSE NUMBER switch) to the number one (1) position. Observe the Digital Panel Meter and PEAK/ALTERNATE/ECD LEDs for both PEAK (VOLTS) and ECD (usec) readings (see Figure 3.3).

2.6.3.3 Monitor the Sample Gate and Operate RF on the oscilloscope (see Figure 2.16). Trigger the oscilloscope from the red test point (TP7) on one of the DRRG modules in the standby low rate timer. The Sample Gate should move from pulse to pulse as the pulse select thumbwheel is rotated from one (1) to nine (9) for master, and from one (1) to eight (8) for a secondary station.

2.6.3.4 Set the PULSE NUMBER thumbwheel to one (1), and observe the alternate PEAK (VOLTS) and ECD (usec) readings on the Digital Panel Meter and alternate lighting of the respective LEDs.

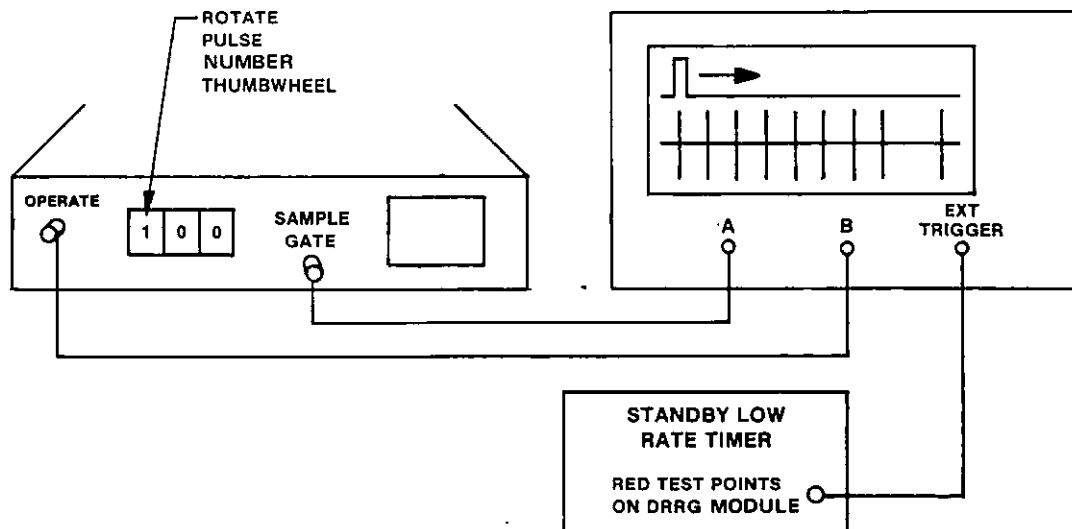


Figure 2.16. Sample Gate Versus Operate RF

2.6.3.5 Make half-cycle readings as follows:

- Set the MODE SELECT switch to the HALF-CYCLE position.
- Set the PULSE NUMBER thumbwheel to one (1).
- Set the PEAK (VOLTS)/ECD (usec) switch to PEAK (VOLTS) position.
- Rotate the two (2) HALF-CYCLE NUMBER thumbwheels from one (1) to nineteen (19) and observe the Digital Panel Meter. The Digital Panel Meter reading should increase, reaching a peak value at about the 13th, 14th, or 15th half-cycle. From then on the voltage should decrease in value.
- Repeat step d. for each position of the PULSE NUMBER thumbwheel from one (1) to eight (8), or nine (9) for a master station.

2.6.3.6 For a dual-rated station, change the RATE SELECT switch to high rate and repeat paragraphs 2.6.3.3 to 2.6.3.5. Use the DRRG red test point of the standby high rate timer.

2.0.3.7 Observe the EPA Full Wave Rectified RF, Reference Envelope, and chart recorder drive as follows (see Figure 2.17):

a. Connect one oscilloscope channel to the REF ENV jack, J2, on the Waveform Panel (this is the same signal that is on the EPA rear panel jack, J9).

b. Connect the other oscilloscope channel to the FWR RF jack, J1, on the Waveform Panel (this is the same signal that is on the EPA rear panel jack, J4).

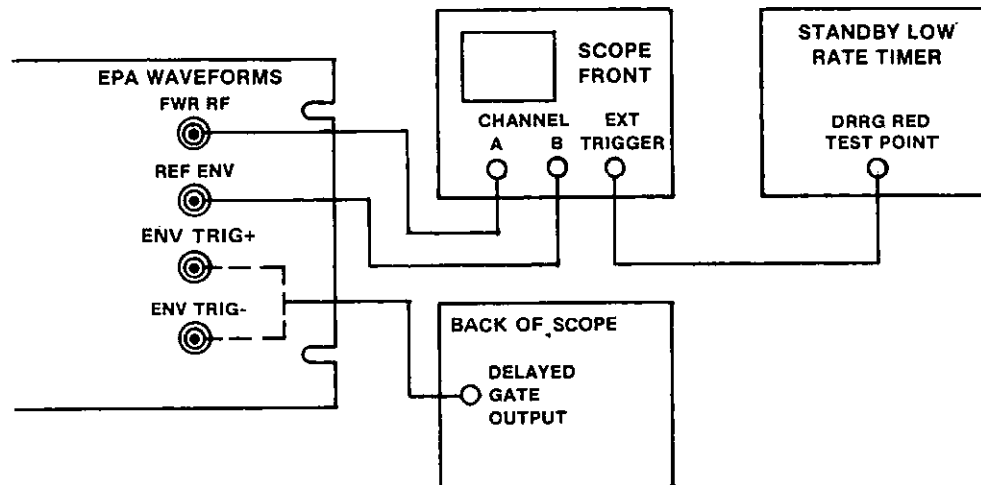


Figure 2.17. Oscilloscope Connections for Monitoring EPA Waveforms

c. Connect the delayed gate output of the oscilloscope to one of the ENV TRIG jacks, J3 (positive) or J4 (negative) on the Waveform Panel, depending upon the polarity of the oscilloscope delayed gate output. These are the same as EPA rear panel jacks, J8 or J5, respectively.

d. Set the horizontal sweep of the oscilloscope to 200 us per division, and the delay sweep to 20 us per division.

e. Adjust the oscilloscope sweep delay to line up the Reference Envelope and the Full Wave Rectified RF waveforms on the oscilloscope.

f. If the station is dual-rated, shift the oscilloscope trigger to the standby high rate timer DRRG red test point, and repeat step e.

g. Check J10 on the rear of the EPA for a voltage of 0-5 volts. A chart recorder can be connected in accordance with Table 2.4. Further information on the chart recorder can be found in the Remote Control Set AN/FNS-2(v) technical manual.

2.6.3.8 Adjust the W0678-11A/CLP ATTN module as follows:

a. On Channel A of the oscilloscope, monitor the Sample Gate (see Figure 5.19) at J3 located on the EPA front panel. If the Sample Gate is not present refer to paragraph 5.3.

b. Place the MODE SELECT switch (S2) in the HALF-CYCLE NUMBER position. Set the PULSE NUMBER thumbwheel to position 1 and the HALF-CYCLE NUMBER to position 08.

c. Remove the chassis mount screws and pull the EPA chassis out far enough from the cabinet so that the top cover of the chassis can be removed. Leave all input/output cables connected to the EPA.

d. On Channel B of the oscilloscope, monitor the Clip Attenuator Gate at TP1 (white test point) on the Clip Attenuator module (see Figure 2.18).

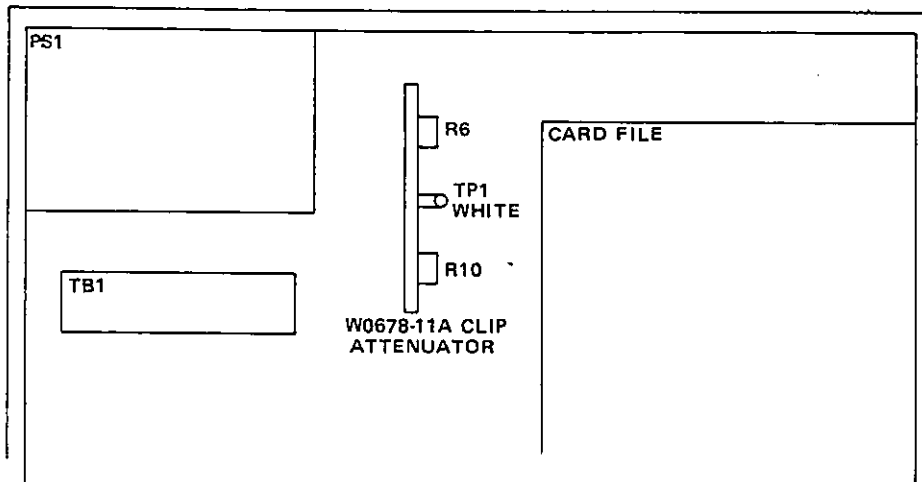


Figure 2.18. Top View of EPA Showing Location of Clip Attenuator Module

e. Adjust R10 on the Clip Attenuator module so that the Sample Gate overlaps with the leading edge of the Clip Attenuator Gate (see Figure 2.19.a).

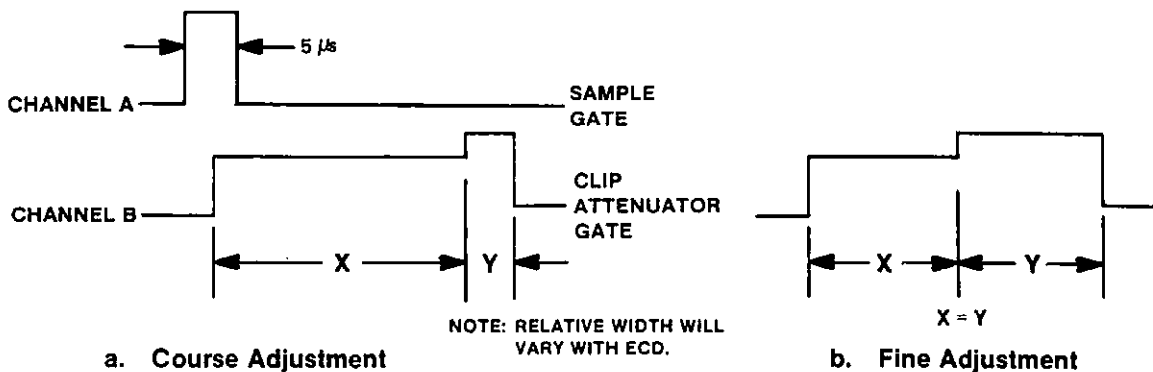




Figure 2.19. Clip Attenuator Waveform Adjust

f. Monitor only the Clip Attenuator Gate and adjust R10 so that $X=Y$ (see Figure 2.19.b).

2.6.3.9 Check for the presence of the Local Envelope Crossover trigger as follows:

- a. Set the Time Interval Counter (TIC) to the following settings:
 - (1) TIME BASE - 0.1 usec.
 - (2) FUNCTION - T.I. A to B.
 - (3) A channel trig - Negative ().
 - (4) B channel trig - Positive ().
 - (5) SAMPLE RATE - Turn clockwise, then fully counterclockwise but not into off detent.
- b. Set the TIC Panel switches to:
 - (1) START thumbwheel - 2.
 - (2) STOP thumbwheel - 3.
 - (3) RATE select switch - LOW RATE.
- c. Observe a LEN number on the TIC digital display.

2.6.3.10 Check the Envelope-to-Cycle-Difference recorder to observe that there is a recorder output from the EPA.

2.6.3.11 Adjust the PEAK (VOLTS) display as follows:

- a. Set the front panel controls as follows:
 - (1) MODE SELECT switch to PULSE NUMBER position.
 - (2) SAMPLE NUMBER switch to 100.
- b. Disable the cycle compensation loop by connecting a jumper from TP2 (Orange) to TP6 (Black) on the M Card of the operate timer (of both rates, if dual-rated).

NOTE

If TP2 (Orange) on the M Card is not jumpered to ground, transmitted signal timing shifts due to the cycle compensation loop may occur.

- c. Remove the chassis cover of the EPA.

WARNING

Hazardous voltages are present in the RF return cable.

- d. Locate and disconnect the keyed twinax connector in the Current Transformer cable (as close to the transformer as possible).

e. Use a 100 ohm, 5%, 1/2 W, resistor and a calibrated oscilloscope to differentially measure the zero-to-peak voltage on the first LORAN-C pulse of the transmitted pulse group. Ensure that the resistor is placed across the plus and minus pins of the twinax connector (refer to Figure 2.20).

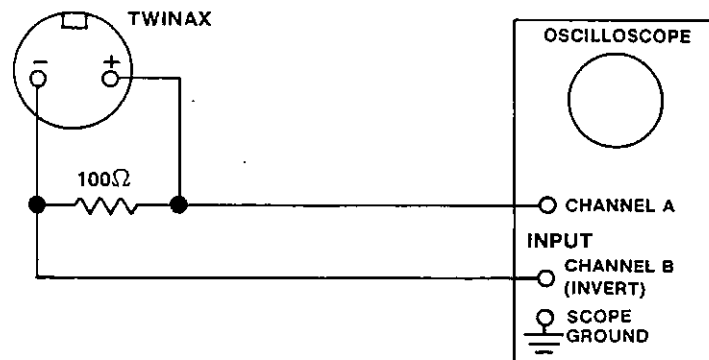


Figure 2.20. Oscilloscope Twinax Connector Test Setup

f. Remove the resistor and reconnect the twinax connector.

g. Adjust the potentiometer (R6) on the Clip Attenuator module (refer to Figure 2.18 for location of R6) until the pulse peak reading on the EPA DPM is the same as the value obtained in step e. (+1 volt) or in accordance with local directives. Since the volt/ampere ratio of the Current Transformer (Pearson Model 1705) is 1/10, the peak current on the antenna may be obtained by multiplying this reading by ten.

h. Replace the top cover on the EPA and re-install the EPA back into the rack using four panel mount screws to securely hold the EPA in place.

i. Enable the cycle compensation loop on the operate timer(s) by removing the jumper(s) from TP2 (Orange) to TP6 (Black) on the M Card(s).

2.6.4 Transmitter Coupler Control initial operation.

2.6.4.1 Perform the following adjustments of the TCC with the AN/FPN-42/44/44A/45 Transmitters:

a. Monitor the peak amplitude of the first LORAN pulse of a group as outlined in paragraph 3.3.2.2. Insure that the transmitter is operating at the prescribed output power.

b. Reduce the transmitter drive adjust on the operate PGEN until the EPA reads a DPM voltage 80% of the prescribed DPM voltage reading, as promulgated by current operating directives. (This corresponds to a 64% radiated power level.)

c. Adjust the TCC threshold detector level adjust, R8 (see Figure 5.13) on the W0678-5/XMTR CON module, clockwise until the OFF AIR lamp goes off, and then counterclockwise until the OFF AIR lamp illuminates. The OFF AIR indicator is a one-half second delayed action indication. Adjust R8 in small increments to avoid over-correction.

d. Return the transmitter drive to the original settings.

e. Repeat steps a. and b. to insure that the OFF AIR alarm condition occurs properly.

2.6.4.2 Perform the following adjustments of the TCC with the AN/FPN-39 Transmitter:

NOTE

Three personnel are required to perform the following checks; two in the transmitter building, and one in the timer room.

a. On the oscilloscope, monitor the amplitude of the pulse group (8 for secondary station, 9 for master station) as outlined in paragraph 3.3.2.2. Ensure that the transmitter is operating at the prescribed output power.

b. Adjust the oscilloscope vertical deflection and position controls until the positive portion of the waveform (the portion from the zero line to the positive peak) measures 5 major divisions.

c. At the transmitter building, lower the plate voltage on the operate transmitter (see the AN/FPN-39 technical manual) until the positive portion of the waveform measures 4 major divisions (this indicates that the transmitter is now at 80% of rated voltage output, which corresponds to 64% rated power).

d. Adjust the TCC threshold detector level adjust, R8 (see Figure 5.13) on the W0678-5/XMTR CON module, clockwise until the OFF AIR lamp extinguishes, and then counterclockwise until the OFF AIR lamp illuminates. The OFF AIR indicator is a one-half second delayed action indication. Adjust R8 in small increments to avoid over-correction.

e. Return the transmitter drive to the original settings.

f. Repeat steps a. and b. to insure that the OFF AIR alarm condition occurs properly.

2.6.5 Pulse Generator initial operations for dual-rated stations.

2.6.5.1 The following are definitions and measurement procedures to be followed in performing adjustments to the Pulse Generator.

NOTE

READ ALL STEPS PRIOR TO STARTING ANY
ADJUSTMENTS.

a. The following are definitions used in the adjustment procedures:

(1) Phase code balance - Operate RF: equal amplitude peaks of the alternately phase coded pulses between the phase code intervals observed at the OPERATE RF jack of the EPA.

(2) Phase code balance - PGEN: equal amplitude peaks of the Transmitter Drive Waveform (TDW) alternately phase coded pulses. Proper phase code balance of the PGEN includes phase offset of less than 100 nsec, as defined below.

(3) Phase code offset of 30-usec zero crossing: the 30-usec zero crossing of a phase coded pulse observed at the TRANSMITTER DRIVE jack on PGEN. The phase offset is the magnitude of the separation between the zero crossing of the positively and negatively phase coded pulses.

(4) Phase jitter of the 30-usec zero crossing: the peak-to-peak phase shift of the 30-usec zero crossing of any operate RF pulse during the crossover epoch.

(5) Droop - The amplitude differences between any individual pulse and any other pulse within the same pulse group.

(6) Group Droop - The amplitude differences between any pulse of one group to any pulse of the other group over the interval.

b. The following are the measurement procedures to be used:

(1) Triggering: Trigger the oscilloscope from the red test point of a DRRG board in the standby timer. This trigger is moved by inserting Local Phase Adjustments (LPAs) into the standby timer. Write down each LPA, as it is inserted, for easy recovery, should it become necessary to switch timers during the measurements. Also, once the LPA necessary to find the 30-usec zero crossing is found, it is a fixed value and can be used for future measurements.

(2) Oscilloscope sweep mode: Never use delayed sweep when measuring phase jitter, as it introduces some jitter. 50 nsec per division is desired to obtain accurate jitter measurements. Use delayed sweep only when determining the LPA necessary to obtain the 30-usec zero crossing.

(3) Obtaining the 30-usec zero crossing: Observe the desired pulse at any sweep time that will display only that pulse at the left side of the display (trigger with TP7 (Red) of DRRG module). Expand the sweep and locate the 30-usec zero crossing. Ensure that the oscilloscope trace is centered on a major horizontal division. Alternately insert LPAs in the standby timer and expand the sweep time to keep the 30-usec zero crossing in the left center of the display. As the display time decreases, reduce the volts per division scale to increase the slope of the waveform. Intensity and focus need to be adjusted accordingly. Upon reaching 50 nsec per division of sweep, center the zero crossing (it is a vertical line) on the display and record the total LPA insertion. Inserting LPAs in 5 usec increments moves the start of the pulse. Inserting LPAs in 1000 usec increments displays the 30-usec zero crossing of the adjacent pulses.

(4) Figures 2.21 and 2.22 show proper and improper phase code balance, respectively. Figure 2.22 is observed when the PSYN module is not properly adjusted (if this occurs, return the module in accordance with E/GICP instructions).

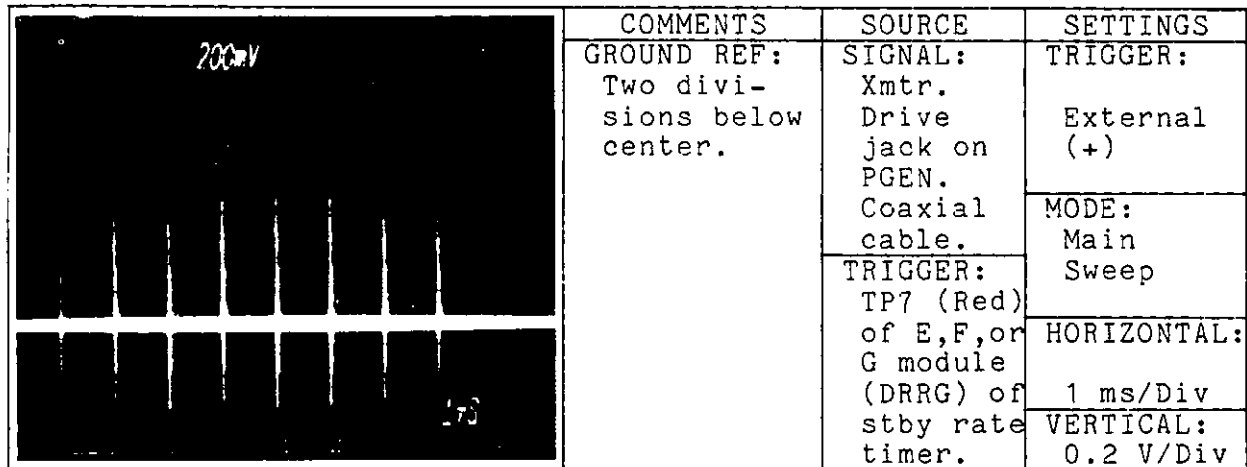


Figure 2.21. Proper Phase Code Amplitude Balance

NOTE

A properly adjusted PSYN module allows the positive and negative halves of the pulses to be balanced.

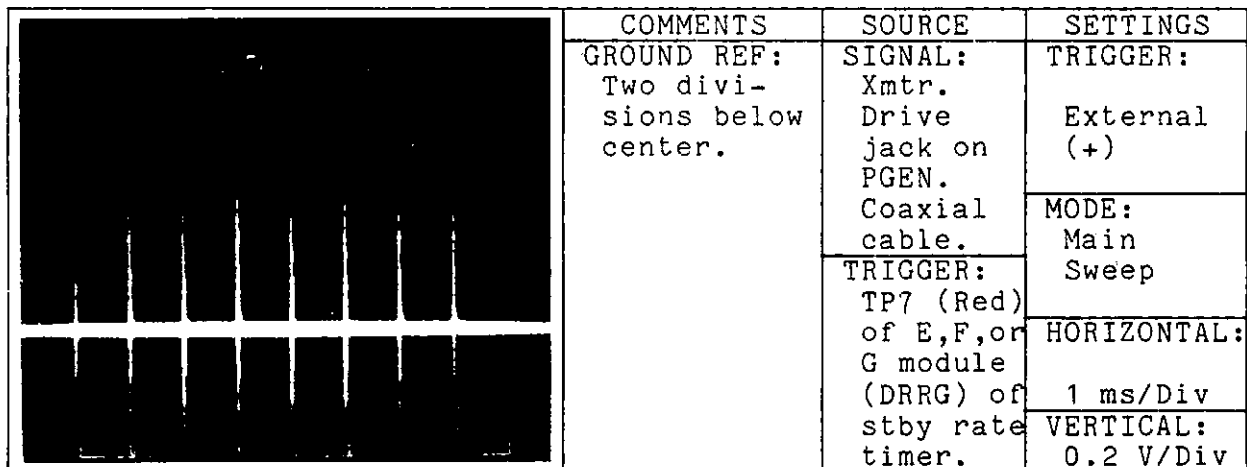


Figure 2.22. Improper Phase Code Amplitude Balance

c. These adjustments ensure a more efficient operation of the transmitter with a minimum of phase jitter.

(1) Adjust the PGEN phase code balance and ensure that the phase offset is less than 100 nsec.

(2) Ensure that the transmitter Power Amplifier (PA) section cathode current is balanced to within 5% tube-to-tube and 5% bank-to-bank. Ensure that PA tube filaments do not exceed the rated voltage. Neutralize the 1st and 2nd Intermediate Power Amplifiers (IPAs). Ensure that the 1st IPA is not in saturation. After the transmitter has been properly balanced, proceed to the adjustments.

d. The following are phase jitter maximums that must be maintained at dual-rated transmitting stations:

(1) Phase jitter of all sixteen pulses must not exceed that described in COMDTINST M16562.4 paragraph 2.B.5.c.

(2) Phase code offset of the alternately phase coded pulses must not exceed 100 nsec.

(3) Phase code amplitude imbalance (bounce) of the transmitter drive waveform (TDW) peaks at the PGEN must not exceed .1 volt, while achieving phase code balance of the Operate RF.

2.6.5.2 W0678-19B/GR DROOP module adjustments for AN/FPN-44/44A/45 Transmitters. Perform the following steps to adjust the W0678-19B/GR DROOP module for use with the AN/FPN-44/44A/45 transmitters without the Feedback Modification.

NOTE

READ ALL STEPS PRIOR TO STARTING ANY ADJUSTMENTS. Steps a. through m. are to be performed on any initial issue or replacement modules, prior to performing step n.

a. Place the DROOP thumbwheels to zeroes (0's) and the TRANSMITTER DRIVE ADJUST to zero. Insure that all modules are programmed according to paragraph 2.5.3.a.

b. Set up a calibrated oscilloscope (with x10 probe) according to Figure 2.23.

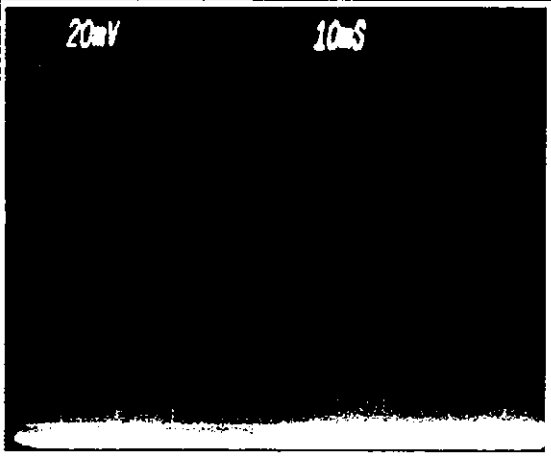
	COMMENTS	SOURCE	SETTINGS
	Channel input coupling switch in ground position. Adjust the scope trace to bottom of graticule.	SIGNAL:	TRIGGER:
		TRIGGER:	Internal Auto MODE: Main Sweep
		HORIZONTAL:	10 ms/Div
		VERTICAL:	0.02 V/Div

Figure 2.23. Oscilloscope Set Up

c. Place the oscilloscope vertical channel input coupling switch to the DC position.

d. Place the oscilloscope Trigger Source switch to External. Trigger the scope from an opposite rate PGEN front panel SCOPE TRIGGER jack (1st MPT selected). This means that if the low rate PGEN is

being adjusted, the trigger would be from the high rate PGEN front panel jack.

e. Connect the oscilloscope to TP4 (Yellow) on the Group Droop module being adjusted. Connect the probe ground clip to the chassis.

f. Record the DC Reference level (see Figure 2.24). This DC reference level should be in the range of +0.9 to 1.1VDC.

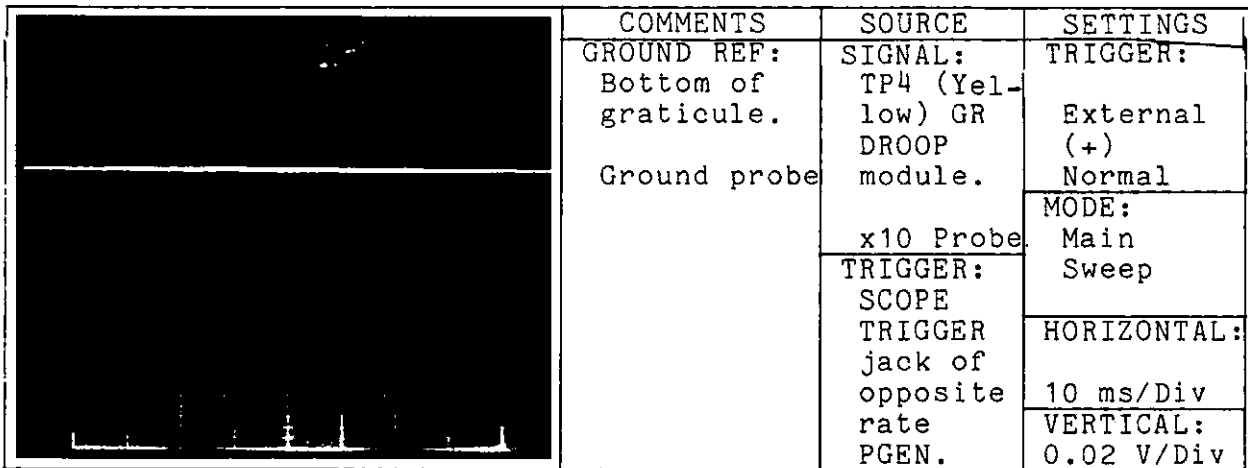


Figure 2.24. DC Reference Level

g. Adjust R1 counterclockwise until a ladder waveform appears (see Figure 2.25) and its peak reaches +1.4VDC. Adjust R12 clockwise until the decay of the ladder waveform reaches the DC level recorded in step f. just before the start of the next ladder waveform. While adjusting R12, it will be necessary to readjust R1 to maintain the peak of the ladder waveform at +1.4VDC.

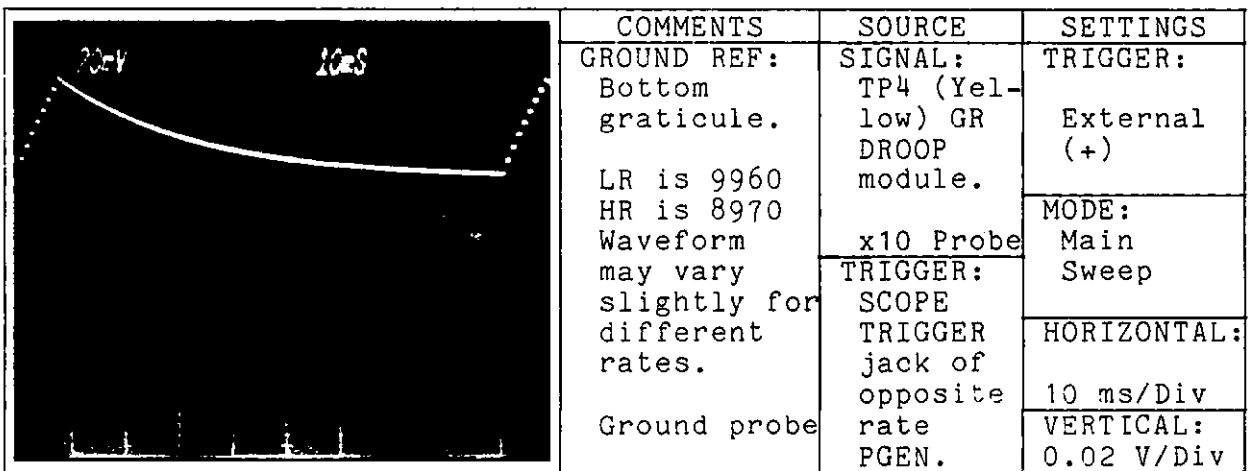


Figure 2.25. Opposite Rate Ladder Waveform

h. Do not readjust R12 again. Adjust R1 clockwise until the ladder waveform just disappears (DC level, signal) see Figure 2.24.

l. Move the oscilloscope trigger cable from the PGEN being adjusted to the SCOPE TRIGGER jack of the PGEN being adjusted.

j. Adjust R5 counterclockwise until a ladder waveform appears (see Figure 2.26) and its peak reaches +1.4VDC. Adjust R10 clockwise until the decay of the ladder waveform reaches the DC Reference level recorded in step f. just before the start of the next ladder waveform. While adjusting R10, it will be necessary to readjust R5 to maintain the peak of the ladder waveform at +1.4VDC.

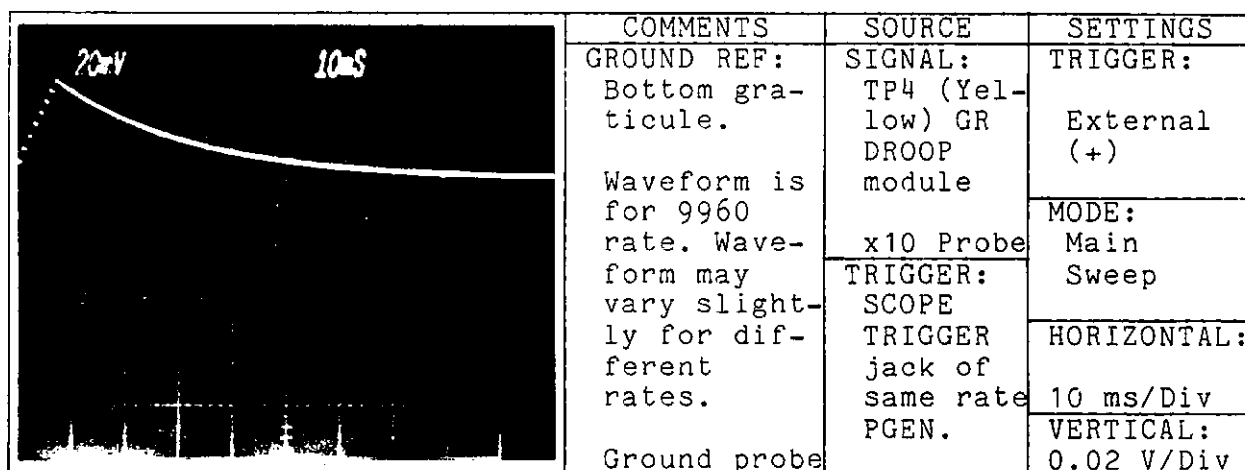


Figure 2.26. Same Rate Ladder Waveform

k. Do not readjust R5 or R10.

l. Move the oscilloscope trigger cable from the PGEN being adjusted to the SCOPE TRIGGER jack of the opposite rate PGEN.

m. Adjust R1 counterclockwise until a stable ladder waveform appears. Both the stable and crossing ladder waveforms will be varying in amplitude. Adjust R1 counterclockwise until the stable waveform reaches +1.4VDC when the crossing ladder waveform nears point A in Figure 2.27. The crossing ladder waveform should be +1.4VDC near point A in Figure 2.27.

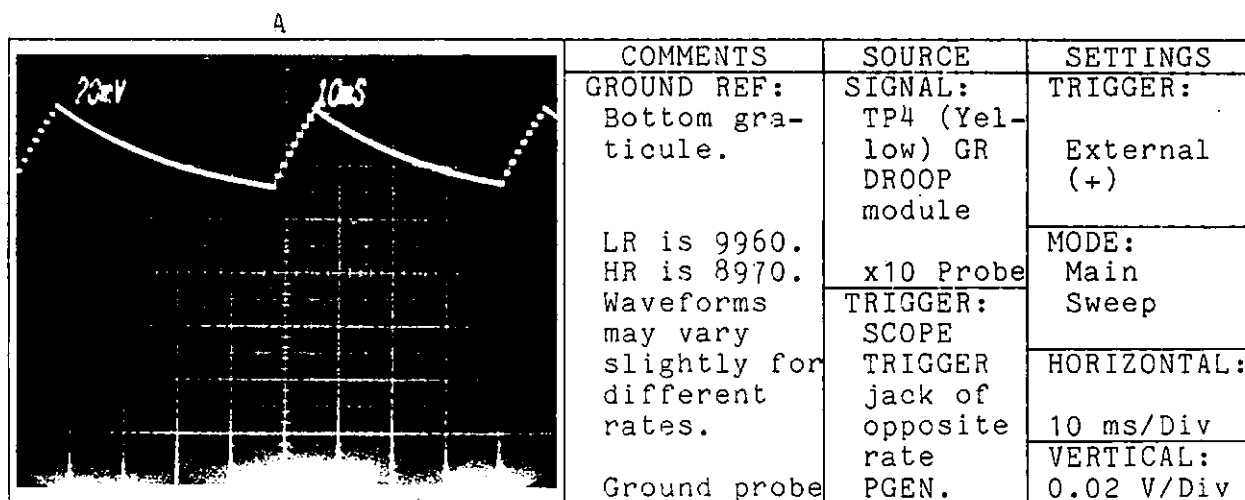


Figure 2.27. Crossing Ladder Waveforms

n. Operate the transmitter in Dummy Load, adjust the PGEN drive to obtain normal drive level and insure that the PGEN is operating correctly.

2.6.5.3 W0678-19B/GR DROOP module initial adjustments for AN/FPN-42 Transmitters. Perform the following steps to adjust the W0678-19B/GR DROOP module for use with the AN/FPN-42 Transmitters:

- a. Ensure that all W0678-19B modules are programmed according to para 2.5.3.b.
- b. Set oscilloscope with zero reference level at the bottom of the graticule with the vertical input set at .02 V/Div. Set the horizontal sweep at 10 msec/div. Use properly calibrated divide by 10 probes.
- c. In the standby high rate PGEN, observe the waveform on TP4 (Yellow) on Channel A of the oscilloscope and trigger the oscilloscope from the SCOPE TRIGGER jack (1st MPT selected) of the same PGEN. Adjust R1, R3, and R11 (see Figure 2.12) until two ladder waveforms are present.
- d. Adjust R11 until the ladder waveforms disappear, then turn R11 in the opposite direction until the ladder waveforms reappear. The DC level of the waveform should be between 1.0 and 1.1 volts. Adjust R3 until the peak of the stable ladder (the other will drift across the screen) is between 1.2 and 1.25 volts.
- e. Move the oscilloscope trigger cable to the SCOPE TRIGGER jack of the low rate standby PGEN. Adjust R1 until the peak of the stable ladder is between 1.2 and 1.25 volts.
- f. Both ladder waveforms are now equal in magnitude, and the DC Reference level is approximately 1.1 volts. There should be no difference in the waveforms when the trigger is moved. If there is, repeat the above steps until the two waveforms are equal. When this is accomplished, this module is the standard. Do not adjust it in any of the following steps. Figures 2.28 and 2.29 show the proper appearance of the "standard" waveform.

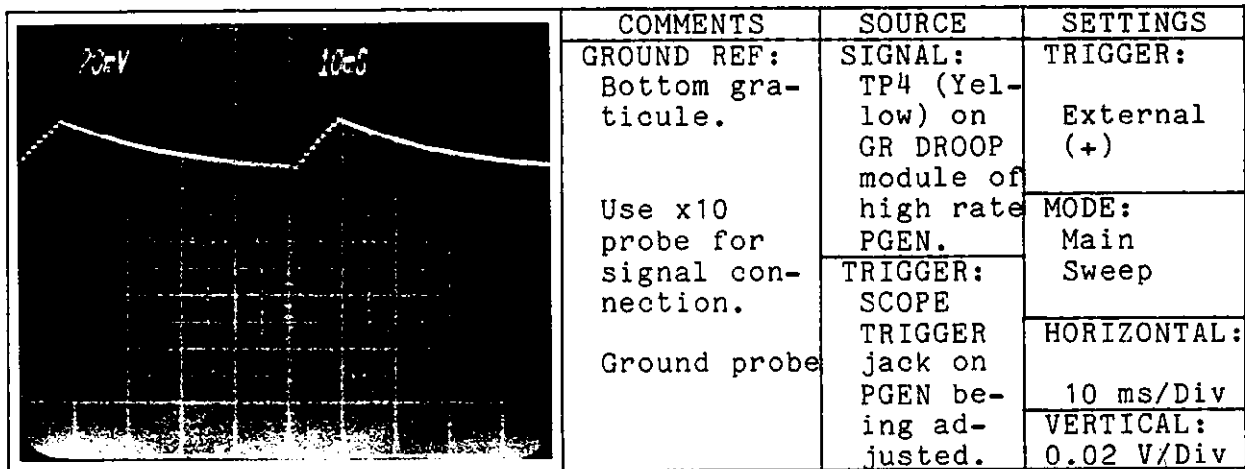


Figure 2.28. Proper Same Rate Ladder Waveform

g. With the standard waveform on Channel A of the oscilloscope, observe the waveform at TP4 (Yellow) on the Group Droop module in the standby low rate PGEN on Channel B (use same settings). Adjust this module using steps (a) thru (f) above. Invert Channel B and add it to Channel A (A+B). Adjust the vertical position control to center the trace when both channels are grounded. Return to the A+B display.

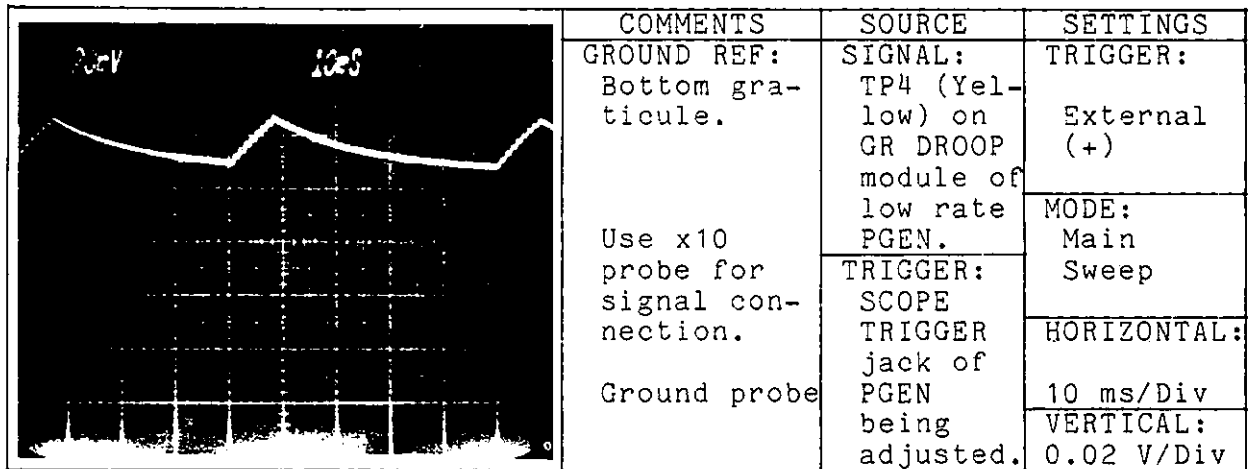


Figure 2.29. Proper Opposite Rate Ladder Waveform

h. With the oscilloscope trigger coming from the same PGEN, adjust R3 for as straight as possible line on the left side of the display. Trigger the oscilloscope from an opposite rate PGEN and adjust R1 for as straight a line as possible on the left side of the display. Adjust R11 for a straight line across the entire display. Repeat these steps until the two waveforms add to a straight line similar to Figure 2.30. Observe Channel B alone and not inverted, to ensure that it is set properly.

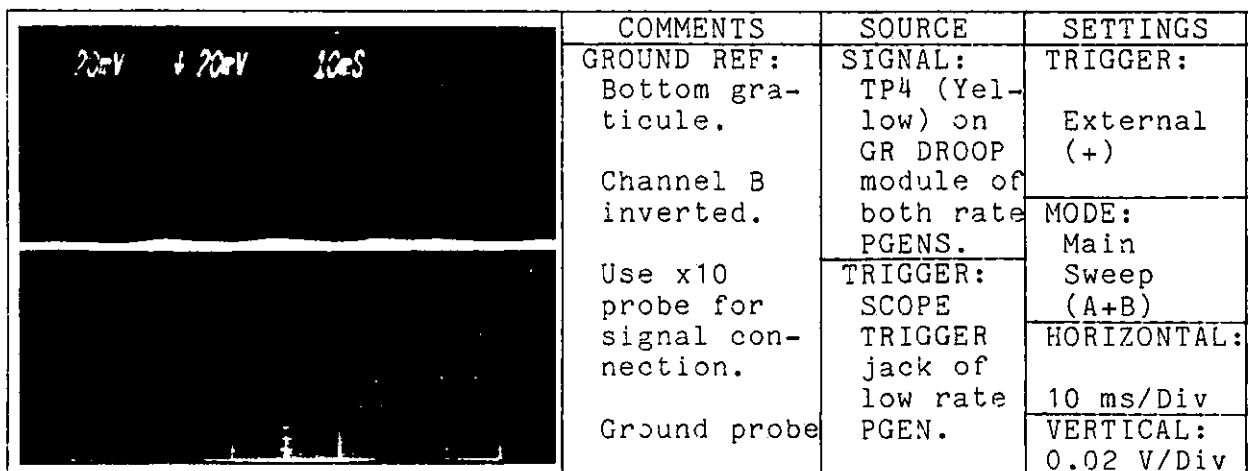


Figure 2.30. A+B Waveform

i. Switch transmitters and adjust the phase code balance and transmitter drive (drive may have to be reduced). Droop should be less than 5% for both the group and pulse train.

NOTE

The following step adjusts droop. Any attempt to improve droop shall maintain the voltage values given in the above steps. During any adjustment ensure that (1) the two ladders on the TP4 waveform are equal in magnitude and (2) the high and low rate TP4 waveforms are identical among all PGENs.

j. Continue to observe the standard waveform on Channel A of the scope, and adjust the remaining PGEN Group Droop modules in accordance with the above steps. Repeat step i, for the other transmitter, first making sure that it is properly balanced. Adjust the spare module. All Group Droop modules should now be interchangeable without any readjustments.

k. The peak-to-peak amplitude of the TDW observed at the PGEN TRANSMITTER DRIVE jack must not exceed 2.5 volts to achieve the constraints in the above paragraph. At this drive level, the station is still able to transmit at its assigned power level.

2.6.5.4 Adjustment procedures for the W0678-20/GR DROOP module. The adjustments for this module are done at the depot.

NOTE

Three personnel are required to perform the following checks; two in the transmitter building, and the other in the timer room.

2.6.6 Operational Checks. Paragraph 2.6.6.1 is a step-by-step check of the TCS equipment. Paragraphs 2.6.6.2 and 2.6.6.3 require the switching of transmitters and contain additional checks. These procedures are written for a dual-rated station, but can be used at a single-rated station, remembering that a single-rated station has only one operate and one standby PGEN. If any of the checks fail, recheck all connections and repeat the checks. If any of the checks still fail, refer to Chapter 5 for the troubleshooting procedures. After the successful completion of the below checks, the Transmitter Control Set will be ready for operation.

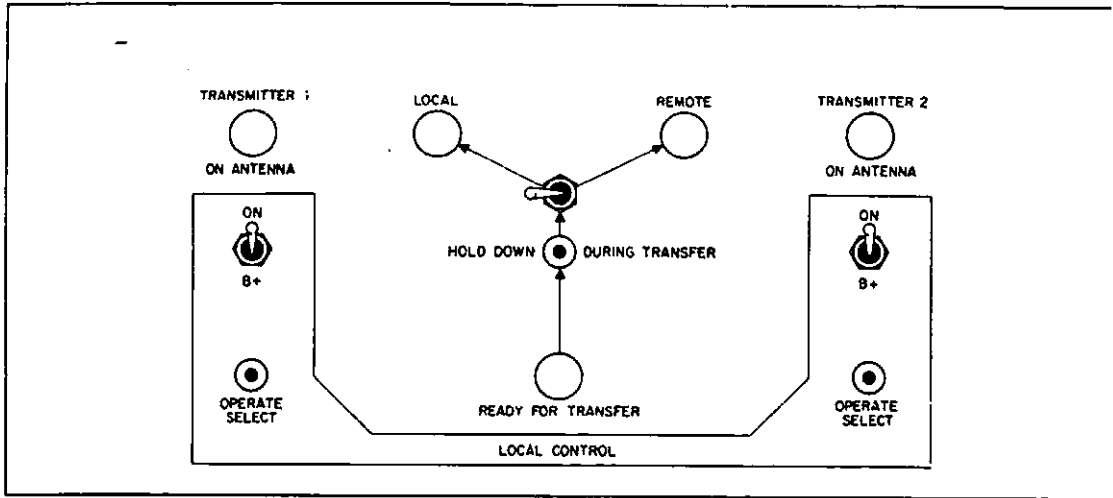
2.6.6.1 Perform the following steps:

a. Insure that the following are set:

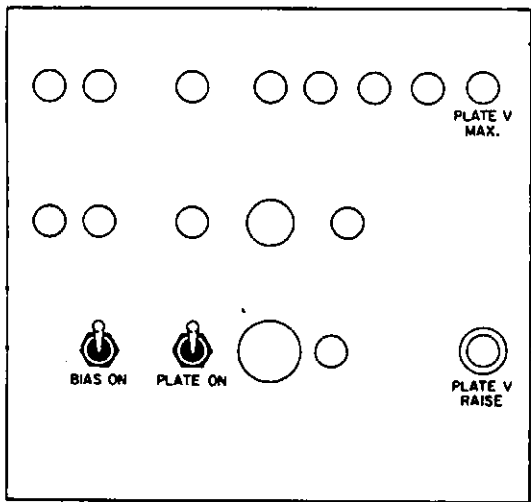
(1) All alarms are off and the TRANSMITTER DRIVE ADJUST on the PGENs is set for full rated power.

(2) The B+ switch turned on for the operate transmitter only on the Local Control Panel. (Figures 2.31-2.34 show the panels and control units of the AN/FPN-39, 42, 44/45 and 44A transmitters respectively).

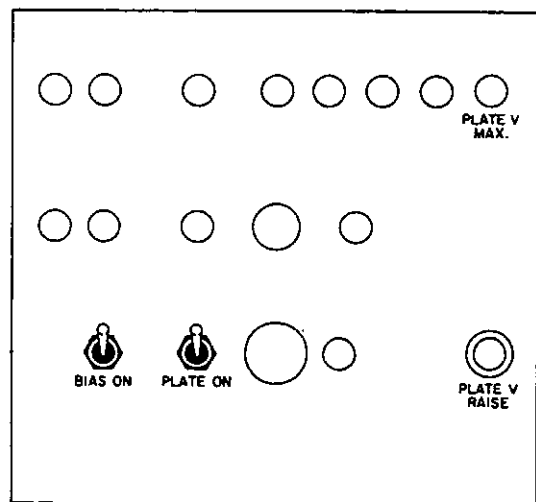
AN/FPN-39 TRANSMITTER



LOCAL CONTROL PANEL IN POWER DISTRIBUTION UNIT (3A4)



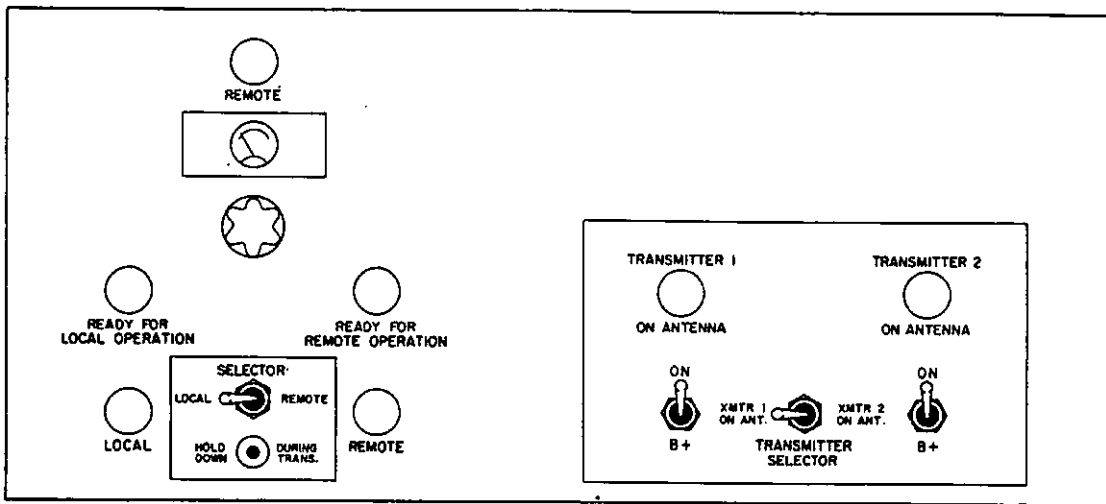
LOW POWER UNIT -(2A8)
TRANSMITTER NO. 1



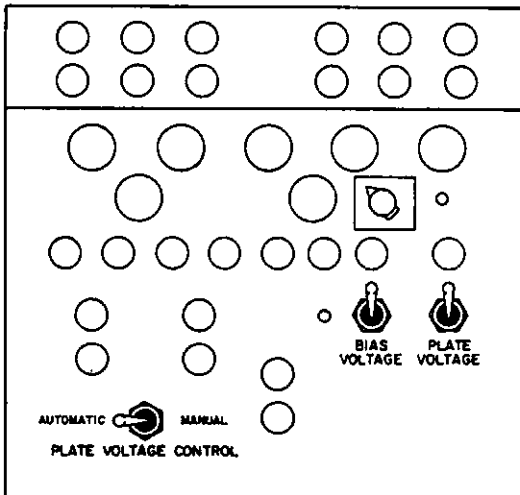
LOW POWER UNIT -(2A8)
TRANSMITTER NO. 2

Figure 2.31. AN/FPN-39 Local Control Panel and Low Power Units

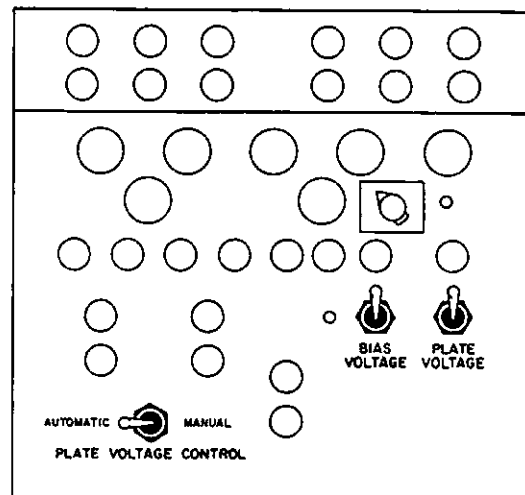
AN/FPN-42 TRANSMITTER



ANTENNA COUPLER CU-807/FPN-42 (4A)



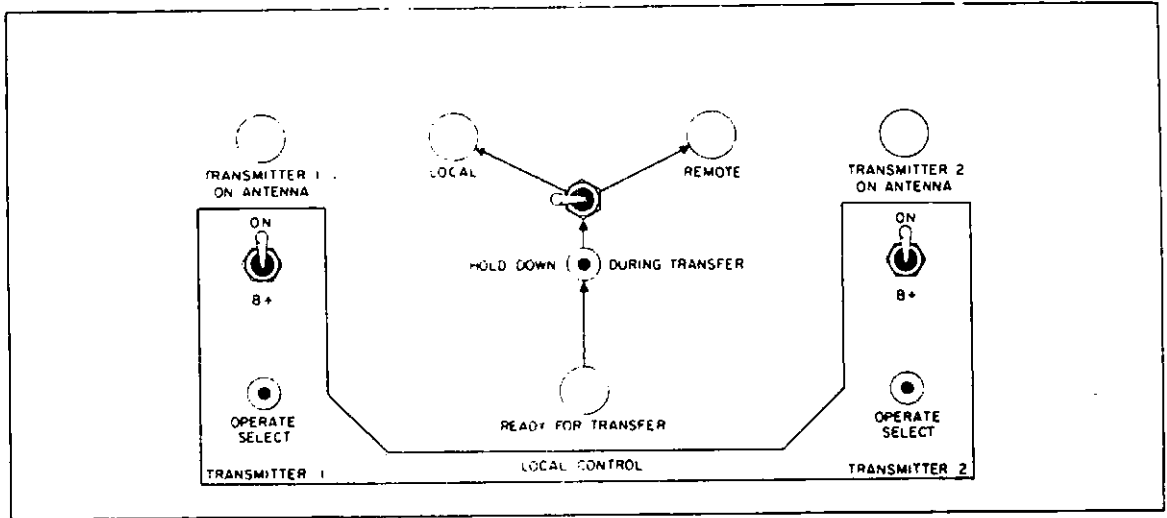
POWER SUPPLY PP-2540 (1A)
TRANSMITTER NO. 1



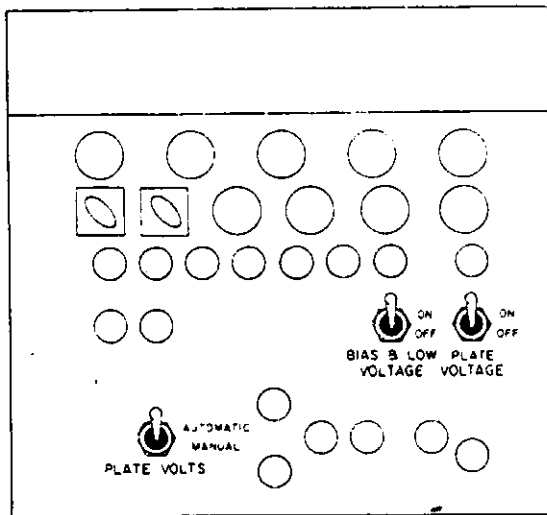
POWER SUPPLY PP-2540 (1A)
TRANSMITTER NO. 2

Figure 2.32. AN/FPN-42 Antenna Coupler and Power Supply Panels

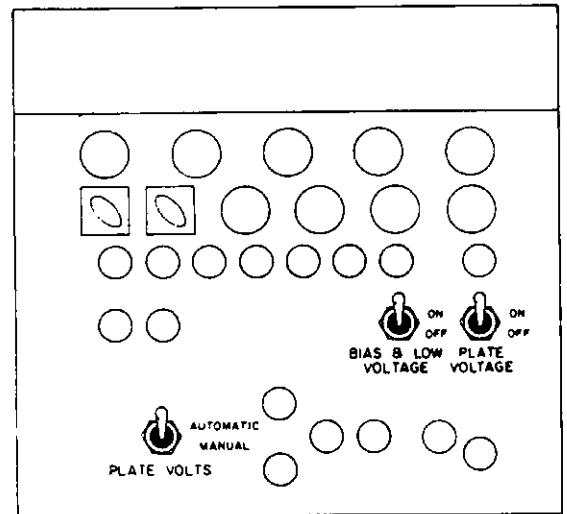
AN/FPN-44/45 TRANSMITTER



LOCAL CONTROL UNIT (UD5)



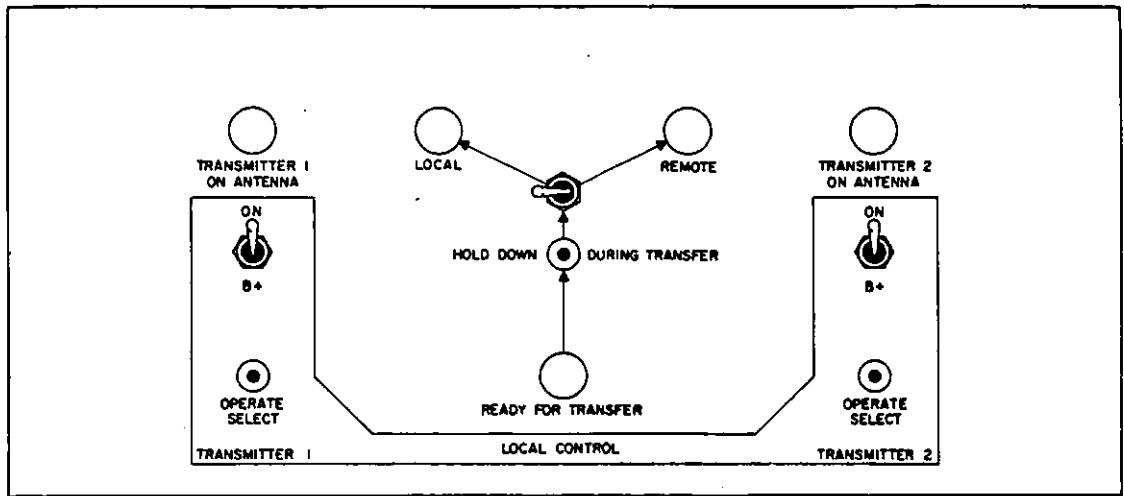
CONTROL INDICATOR C-4752 (IA3A2)
TRANSMITTER NO. 1



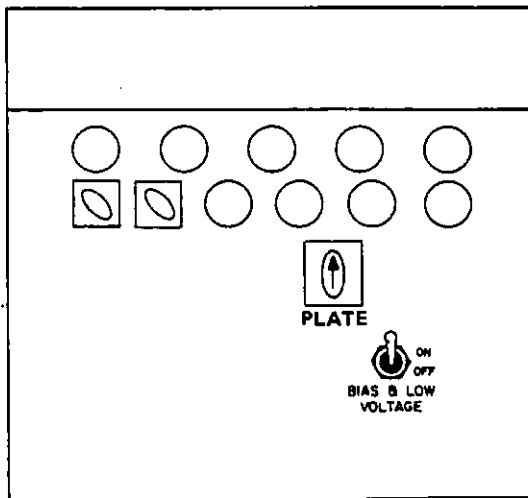
CONTROL INDICATOR C-4752 (IA3A2)
TRANSMITTER NO. 2

Figure 2.33. AN/FPN-44/45 Local Control and Control Indicator Panels

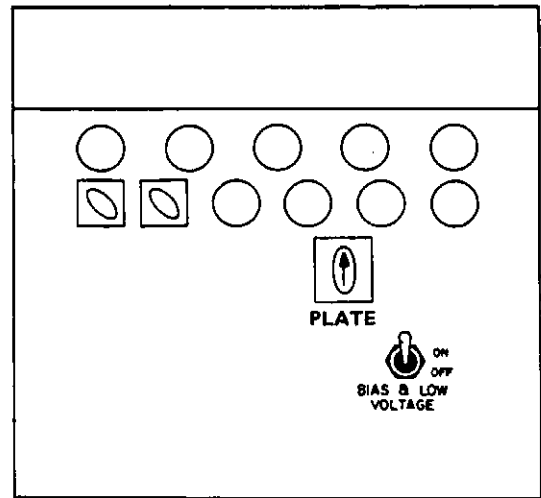
AN/FPN-44A TRANSMITTER



LOCAL CONTROL UNIT (UD5)



CONTROL INDICATOR C-10034 (1A53A2)
TRANSMITTER NO. 1



CONTROL INDICATOR C-10034 (1A53A2)
TRANSMITTER NO. 2

Figure 2.34. AN/FPN-44A Local Control and Control Indicator Panels

(3) The LOCAL/REMOTE switch on the Local Control Panel is in the LOCAL position.

(4) The BIAS switch turned on for both transmitters. The plate volts automatic switch in AUTOMATIC position. (both are on the transmitter, see Figures 2.32-2.33).

(5) Transmitter No.1 is the operate transmitter.

b. Press the LAMP TEST switch on the TCC, and the following should occur:

(1) All lights on the TCC illuminate.

(2) The Audio alarm sounds.

(3) The PGEN ALARM and OPERATE LEDs illuminate.

c. Release the LAMP TEST switch, and the following Lamps/LEDs remain lit:

(1) OPERATE LEDs on the operate PGENs.

(2) ON THE TCC: TRANSMITTER BUILDING CONTROL, TRANSMITTER 1 OPERATE, TRANSMITTER 2 STANDBY.

(3) ON THE LOCAL CONTROL PANEL: READY FOR LOCAL OPERATION and LOCAL CONTROL (AN/FPN-42), and READY FOR TRANSFER (AN/FPN-39/44/44A/45).

d. Record the present setting of the TRANSMITTER DRIVE ADJUST, for future reference. Turn the TRANSMITTER DRIVE ADJUST of the operate and standby PGENs, of the same rate, fully counterclockwise and observe the TCC OFF AIR and TRANSMITTER FAILURE lamps illuminate and the TRANSMITTER 2 STANDBY lamp extinguishes. Thirty seconds later the Audio alarm sounds.

e. Return the TRANSMITTER DRIVE ADJUST of the PGENs to the recorded settings of step d. The OFF AIR and TRANSMITTER FAILURE lamps extinguish, and the TRANSMITTER 2 STANDBY lamp illuminates.

f. Turn the standby transmitter BIAS switch off. The TRANSMITTER 2 STANDBY lamp extinguishes and the TRANSMITTER FAILURE lamp illuminates. The TRANSMITTER 1 OPERATE lamp blinks off for approximately 1 second.

g. Turn the standby transmitter BIAS switch on. The TRANSMITTER FAILURE lamp extinguishes. The TRANSMITTER 2 STANDBY lamp illuminates. The TRANSMITTER 1 OPERATE lamp blinks off for approximately 1 second.

h. Turn the TRANSMITTER DRIVE ADJUST of a standby PGEN fully counterclockwise. The NO TRANSMITTER DRIVE LED of the PGEN and the TRANSMITTER FAILURE lamp of the TCC illuminate. The TRANSMITTER 2 STANDBY lamp extinguishes.

i. Return the TRANSMITTER DRIVE ADJUST of the standby PGEN to its original position. The NO TRANSMITTER DRIVE LED of the PGEN and the TRANSMITTER FAILURE lamp of the TCC extinguish. The TRANSMITTER 2 STANDBY lamp illuminates.

2.6.6.2 The following steps require switching transmitters.

a. On the Local Control Panel, turn off the operate transmitter B+ switch, couple transmitter No. 2 to the antenna, turn on the B+ switch for transmitter No. 2, and observe the following indications:

(1) On the Local Control Panel, the READY FOR TRANSFER (AN/FPN-39/44/44A/45), TRANSMITTER 2 ON ANTENNA (all), READY FOR LOCAL OPERATION (AN/FPN-42), and LOCAL (all) lamps illuminate.

(2) On the TCC, the TRANSMITTER BUILDING CONTROL, TRANSMITTER 2 OPERATE, and TRANSMITTER 1 STANDBY lamps illuminate.

b. On the TCC, press the SWITCH TRANSMITTERS switch. There is no effect, as the system is in local control. Press the STANDBY TRANSMITTER B+ switch. There is no effect, as the system is in local control.

c. Repeat steps d. through i. of the paragraph 2.6.6.1.

d. Press the HOLD DOWN TO TRANSFER switch. Place the LOCAL/REMOTE switch on the Local Control Panel in the REMOTE position. Then release the HOLD DOWN TO TRANSFER switch. Observe on the TCC, that the TRANSMITTER BUILDING CONTROL lamp extinguishes, and the AUTOMATIC CONTROL lamp illuminates.

e. Press the STANDBY TRANSMITTER B+ switch on the TCC. Observe that the STANDBY TRANSMITTER B+ lamp illuminates.

f. Press the STANDBY TRANSMITTER B+ switch again. Observe that the STANDBY TRANSMITTER B+ lamp extinguishes.

g. Turn the TRANSMITTER DRIVE ADJUST of an operate PGEN fully counterclockwise. The OFF AIR lamp on the TCC illuminates.

h. Within 30 seconds of the above step, return the TRANSMITTER DRIVE ADJUST of the operate PGEN to its original position. This must be done to stop the automatic transmitter switch sequence. The OFF AIR lamp extinguishes.

i. Turn the TRANSMITTER DRIVE ADJUST of a standby PGEN fully counterclockwise. Observe that the PGEN's ALARM LED and TRANSMITTER FAILURE lamp illuminate and the Audio alarm sounds.

j. Press the SWITCH TRANSMITTER switch and observe that a transmitter switch does not occur.

k. Press the STANDBY TRANSMITTER B+ switch and observe that the STANDBY TRANSMITTER B+ lamp on the TCC illuminates. Press the switch again to extinguish the lamp.

l. Return the TRANSMITTER DRIVE ADJUST of the standby PGEN to its original position. This extinguishes the TRANSMITTER FAILURE lamp and secures the Audio alarm.

m. Turn off the standby transmitter BIAS switch. Observe that the TRANSMITTER FAILURE lamp illuminates, Audio alarm sounds, and that the TRANSMITTER 1 STANDBY lamp extinguishes.

n. Press the SWITCH TRANSMITTERS switch. Observe that a transmitter switch did not occur. The standby transmitter bias was turned off in the previous step, therefore, the standby transmitter is inoperative.

o. Press the STANDBY TRANSMITTER B+ switch and observe that the STANDBY TRANSMITTER B+ lamp remains extinguished (no standby transmitter).

p. Turn on the standby transmitter BIAS switch. Observe that the TRANSMITTER FAILURE lamp extinguishes and the Audio alarm is secured. Also observe, that the TRANSMITTER 1 STANDBY lamp illuminates.

2.6.6.3 Perform the the following steps to check the automatic transmitter change sequence:

a. Turn the TRANSMITTER DRIVE ADJUST of an operate PGEN fully counterclockwise. Observe the OFF AIR lamp illuminate. Thirty seconds later, observe the following:

(1) Different operate PGENs indicated.

(2) The TRANSMITTER 2 OPERATE, TRANSMITTER 1 STANDBY, and TRANSMITTER 2 ON ANTENNA lamps extinguish.

(3) The TRANSMITTER 1 ON ANTENNA and TRANSMITTER FAILURE lamps illuminate and the Audio alarm sounds.

b. Eight seconds later, observe that the TRANSMITTER 1 OPERATE lamp illuminates.

c. Eight to sixteen seconds later, observe the OFF AIR lamp extinguish.

d. Return the TRANSMITTER DRIVE ADJUST of the now standby PGEN to its original position. This clears the TRANSMITTER FAILURE lamp and secures the Audio alarm.

e. Press the SWITCH TRANSMITTERS switch on the TCC. Observe the following:

(1) The SWITCH TRANSMITTERS lamp remains lit during the pressing of the switch.

(2) The TRANSMITTER 1 ON ANTENNA, TRANSMITTER 1 OPERATE, and TRANSMITTER 2 STANDBY lamps extinguish.

(3) The OFF AIR, TRANSMITTER 1 STANDBY, and TRANSMITTER 2 ON ANTENNA lamps illuminate.

(4) Eight seconds later, observe the TRANSMITTER 2 OPERATE lamp illuminate.

(5) Eight to sixteen seconds later, observe the OFF AIR lamp extinguish.

2.6.6.4 This completes the initial operation. Install other equipments of the Loran system.

2.34

2.6.7 TCS Input Signals. Table 2.6 is a list of the Input Signals to the Transmitter Control Set.

Table 2.6. AN/FPN-60(V) INPUT SIGNALS

	EQUIPMENT	JACK OR TERMINAL	SIGNAL
INPUTS TO TCS	EPA	J12 J13	PCI High Rate PCI Low Rate
	WP	J3 J4	ENV TRIG + ENV TRIG -
	I/F	J1	High Rate 100 kHz
		J2	High Rate MPT
		J3	High Rate PC Reset
		J4	High Rate PC Set
		J5	High Rate Local Interval
		J7	High Rate Local Interval
		J8	Low Rate 100 kHz
		J9	Low Rate MPT
		J10	Low Rate PC Reset
		J11	Low Rate PC Set
		J12	Low Rate ET & EMPT
		J14	Low Rate Local Interval
		J23A	XMTR No. 1 AC Control Voltage Common
		J23B	XMTR No. 1 Ready Relay
		J23D	XMTR No. 1 Plate on Return
		J23E	Antenna Switching, XMTR No. 2 to Antenna
		J23F	Antenna Switching, XMTR No. 1 to Antenna
		J23G	Remote DC Common
	J23H	Ready for Remote Common	
	J23J	Standby XMTR AC Common	
	J23L	XMTR No. 2 AC Control Voltage Common	
	J23M	XMTR No. 2 Ready Relay	
	J23P	XMTR No. 2 Plate on Return	
	J23R	XMTR No. 2 Operate Relay	
	J23S	XMTR No. 1 Ready for Remote	
	J23T	XMTR No. 2 Ready for Remote	
	J23U	Remote Relay	
	J25	Operate RF	
	J26	Standby RF	

2.6.8 TCS Output Signals. Table 2.7 is a list of the Output Signals to the Transmitter Control Set.

Table 2.7. AN/FPN-60(V) OUTPUT SIGNALS

	EQUIPMENT	JACK OR TERMINAL	SIGNAL
OUTPUTS FROM TCS	I/F	J6 J13 J19 J28 J30 J32 J34 J36 J38	High Rate Operate RF Low Rate Operate RF TCS Alarm Data XMTR No. 1 Drive Waveform XMTR No. 2 Drive Waveform M175 No. 1 M175 No. 2 XMTR No. 1 ET & EMPT XMTR No. 2 ET & EMPT
	EPA	J10 J11	ECD Chart Recorder Drive LOCAL ENV X-OVER (+ TRIGGER ONLY)

2.7 Tail Drive Adjustment. Tail Drive adjustment procedures apply only to the W0678-19B/GR DROOP module for the AN/FPN-44/44A/45 Transmitters with feedback modification installed.

a. The Group Droop module (W0678-19B/GR-DR) is used to generate a tail drive signal for AN/FPN-44A/44B/45B Transmitters that have the Feedback modification installed. The Group Droop section of this module is not used.

b. The preliminary adjustments outlined in section 2.7.1.1 are performed on the Pulse Generators (PGENS) that are driving the standby transmitter. This will ensure a drive signal that requires a minimum of on-air adjustments. This will also verify that the module is operating properly.

c. Prior to beginning, confirm that the transmitted pulse shape meets all specifications for its leading edge. In addition, ensure that the transmitted pulse follows the Electrical Pulse Analyzer's (EPA) Reference Envelope as closely as possible, from 65-80 usec, as measured from the start of the pulse. It is essential that this portion of the transmitted pulse be properly adjusted to obtain the optimum level of tail drive.

2.7.1 Group Droop Module Programming and Initial Settings. Prior to installing a Group Droop module in the standby PGEN, perform Steps a through c below.

a. Ensure that no jumper wires are installed on Headers E2 and E4. These jumpers are not required.

b. Verify that Q4 and C10 are installed on the module (see figure 2.35). If Q4 or C10 are not installed obtain a replacement module.

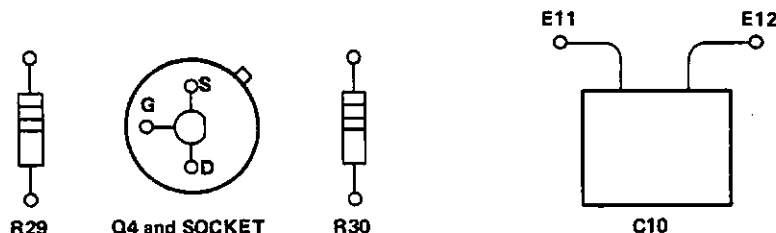


FIGURE 2.35 Q4 and C10 LOCATIONS

c. Adjust the potentiometers located on the edge of the Group Droop module (see figure 2.12) as follows:

- (1) Rotate R25 fully clockwise (CW).
- (2) R1, R3, R5, R10, R11 and R12 are not used and no adjustments are required to these potentiometers.

d. When steps a through c have been completed, the Group Droop module is ready to be installed. Place the transmitters in local control and set the Plate switch of the standby transmitter in the off position. Unplug the standby PGEN to be used, and install the Group Droop module in the middle slot. Set all PGEN DROOP thumbwheel switches to their normal settings and adjust the TRANSMITTER DRIVE ADJUST to its normal level. If the PGENs are operated in the FULL CYCLE mode set the 8th thumbwheel switch to zero. If the PGENs are operated in the 1/2 CYCLE mode set the 16th thumbwheel switch to zero. Apply power to the PGEN.

2.7.1.1 INITIAL ADJUSTMENT PROCEDURE The following are step by step instructions for adjusting the Group Droop module. Figures 2.36 through 2.37 referenced during these steps are signal waveforms for a dual-rated station. If you are unable to obtain any of the waveforms described in this procedure, first ensure correct test equipment setup. Return the module for repair if this doesn't correct the problem. Due to cross-rate blanking either rate signals may disappear momentarily.

a. Monitor the Transmitter Drive Waveform at the PGEN front panel jack. Using the delayed sweep mode of the oscilloscope (20usec/div), display the drive waveform for the 5th pulse (see figure 2.36).

b. Adjust the 8th/16th PGEN thumbwheel switch so that the first 1/2 cycle of tail drive does not exceed the level of the last 1/2 cycle of normal drive. (see figure 2.37).

c. Adjust R25 counter clockwise (CCW) so that the tail drive decays to zero \pm 40 millivolts at approximately 140 usec from the start of the drive waveform. (see figure 2.37).

d. If the station is dual-rated repeat steps a,b, and c for the other rate PGEN.

2.7.1.2 This completes the initial adjustment procedure. Operate the standby transmitter into the dummy load and check for proper operation of the equipment.

2.7.1.3 ON-AIR ADJUSTMENTS The on-air adjustment of the Group Droop module will require that the operator be familiar with the effect that R25 has on the transmitter drive waveform. The following steps are the suggested method of performing the on-air adjustments to obtain optimum transmitted signal parameters. All adjustments are made to the operate PGENs. Place the transmitter to be adjusted on air.

a. Monitor the transmitted signal from the EPA front panel OPERATE jack. Trigger the oscilloscope from the PGEN of the rate to be adjusted.

b. Using the procedure outlined in Paragraph 2.7.1.1, set up the oscilloscope to monitor the Reference Envelope and the transmitted signals 5th pulse.

c. If the transmitted tail does not match the level of the Reference Envelope at 80 usec, adjust the 8th/16th thumbwheel switch to achieve the closest match. (see figures 2.38 and 2.39)

d. Adjust R25 in small increments so that the transmitted tail matches as closely as possible the Reference Envelope between 80-120 usec, measured from the start of the pulse. (see figure 2.39)

e. If the station is dual-rated, repeat steps a. through d. for the other rate PGEN.

2.7.1.4 This completes the adjustment procedure for this transmitter /PGEN combination. Repeat steps 2.7.1.1 and 2.7.1.3 for the other transmitter/PGEN combination (if it has not been adjusted).

2.7.1.5 REPLACEMENT OF EXISTING GROUP DROOP MODULES The drive waveform for each Group Droop module should be recorded, using a scope camera if possible. When a Group Droop module fails, the replacement module can be adjusted to the recorded waveform while operating as standby equipment. This will reduce the amount of on-air adjustments required.

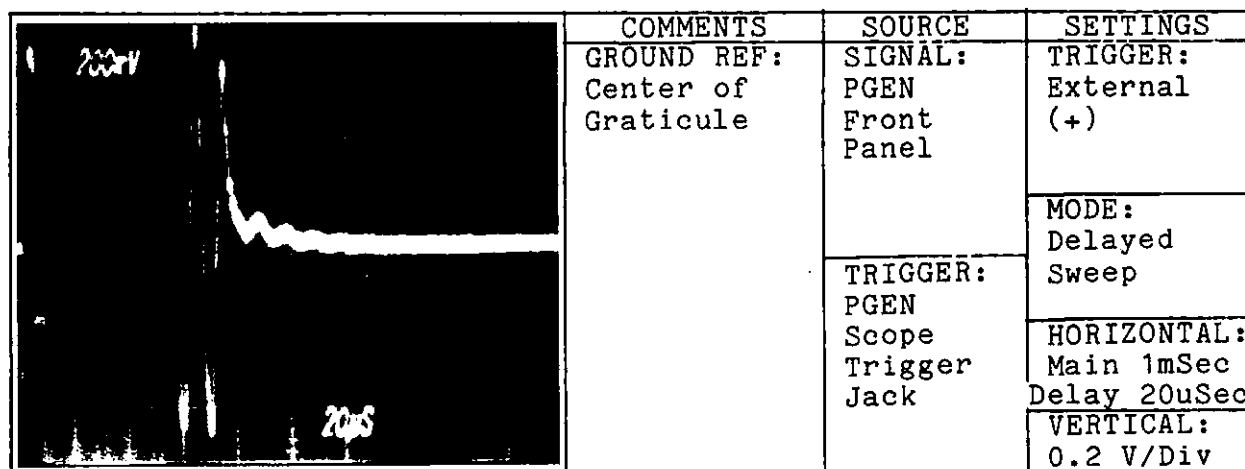


Figure 2.36. Transmitter Drive Waveform without Tail Drive

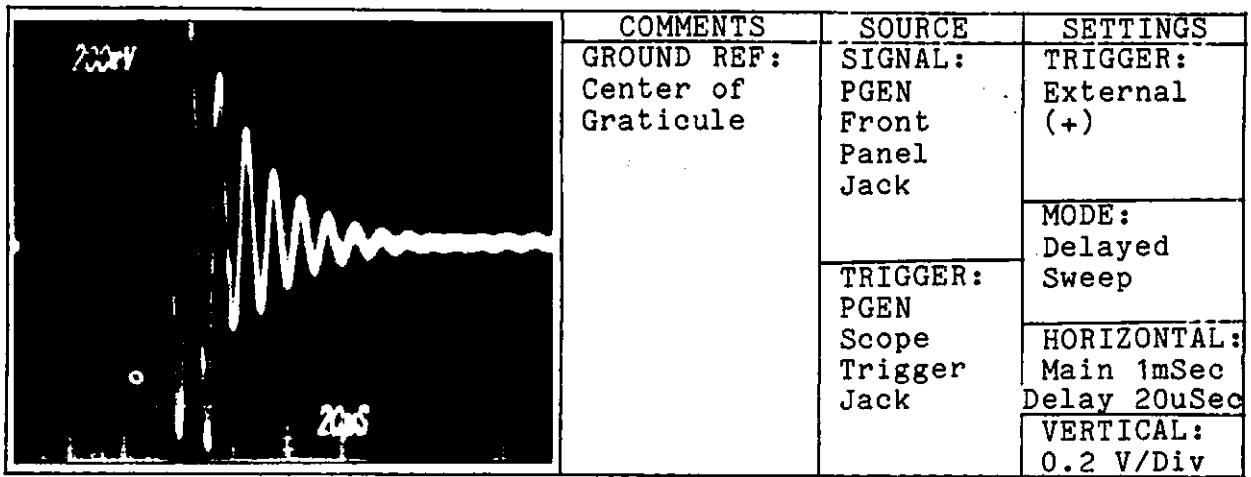


Figure 2.37. Transmitter Drive Waveform with Tail Drive

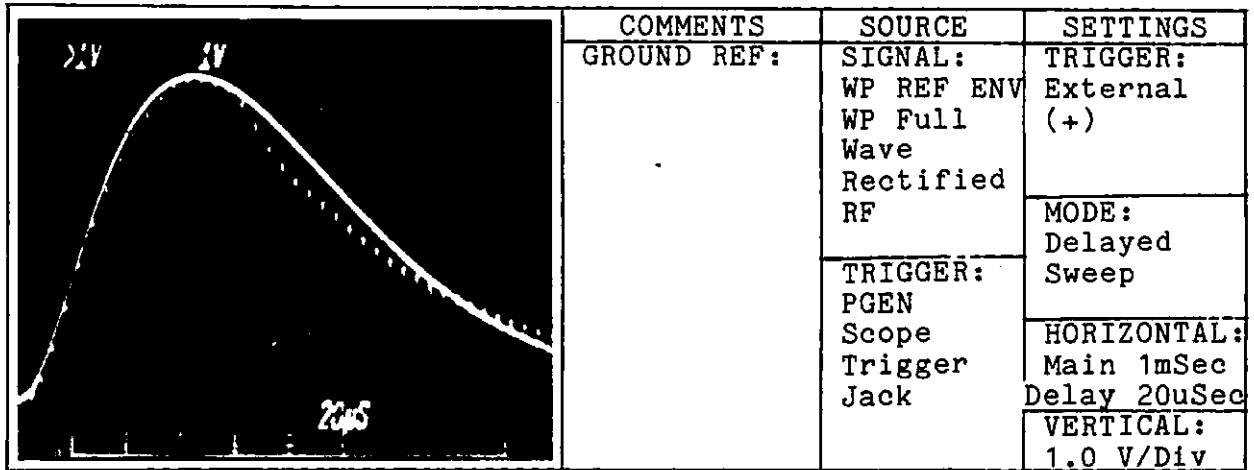


Figure 2.38. RF Waveform and Reference Envelope without Tail Drive

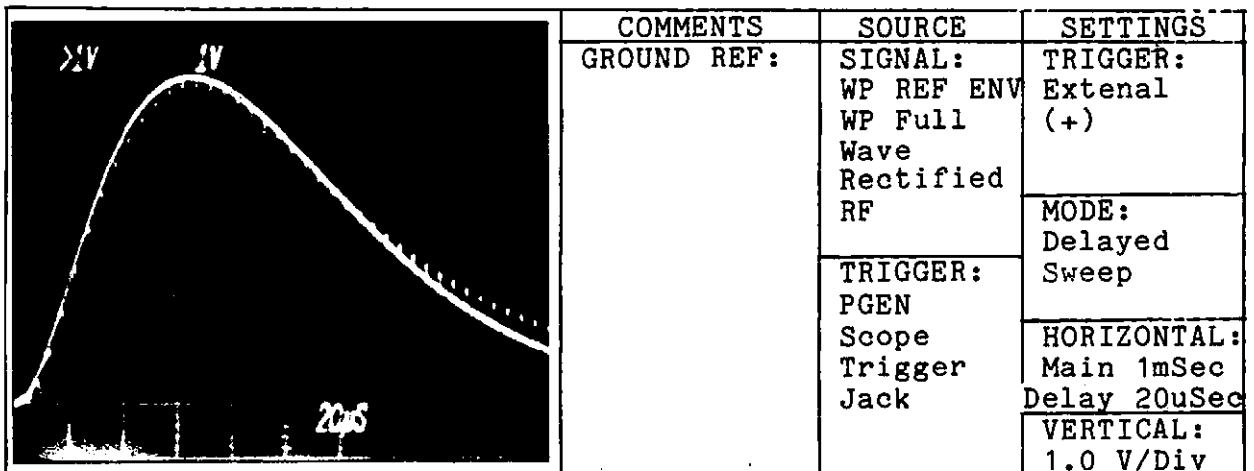


Figure 2.39. RF Waveform and Reference Envelope with Tail Drive

2.8 De-installation and Shipping. Paragraph 2.8.1 contains instructions for the complete de-installation of the TCS units. Paragraph 2.8.2 contains instructions for the de-installation of some of the TCS units, while maintaining operations. Paragraph 2.8.3 contains instructions for the shipping of the unit involved.

2.8.1 De-energize the unit to be de-installed. Disconnect all cables from the unit. Remove the unit from the equipment rack.

2.8.2 Below are procedures to de-install TCS units, while maintaining operations:

NOTE

Take local control prior to the removal of any unit. If the removal of the EPA or TCC takes too long, the cycle compensation loop will jump, due to OP RF load change and amplitude shift.

a. Standby PGEN(s) - unplug unit, disconnect all cables, and remove from the equipment rack.

b. Electrical Pulse Analyzer (EPA)

(1) Unplug AC power cord.

(2) Disconnect all cables.

(3) Reconnect W0678-8/PA Interconnect cable to dummy load (see Figure 2.40 for dummy load internal wiring).

(4) Remove from equipment cabinet.

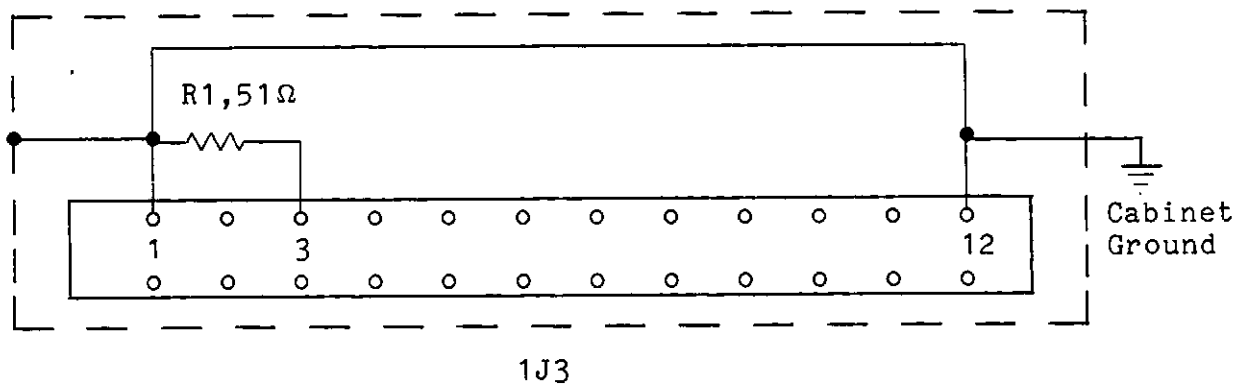


Figure 2.40. EPA Dummy Load Internal Wiring

2.8.2.c. Transmitter Coupler Control (TCC)

- (1) Place transmitters in Transmitter Building Control.
- (2) Unplug AC power cord.
- (3) Disconnect all cables.
- (4) Reconnect W0678-7/Interconnect cable to dummy load (see Figure 2.41 for dummy load internal wiring).
- (5) Remove from equipment cabinet.

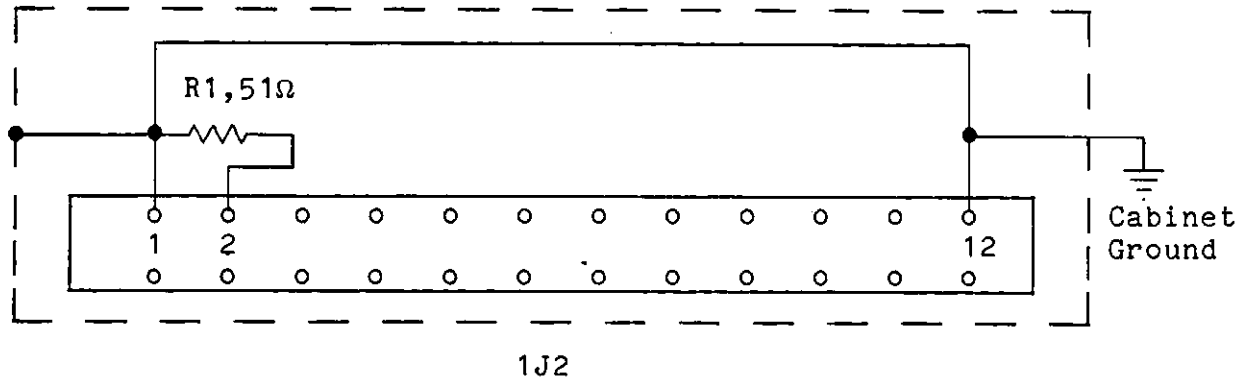


Figure 2.41. TCC Dummy Load Internal Wiring

2.8.3 Return the defective unit in the accordance with applicable instructions. Refer to MIL-E-17555G for packing instructions.



CHAPTER 3

OPERATION

3.1 Introduction. The Transmitter Control Set provides various alarm and transmitter status information to the watchstander. It also routes the drive signal to the transmitter and monitors various parameters of the transmitted signal. The Switch Assembly, TCC, EPA, PGENs, and Waveform Panel have controls and/or indicators listed in the following paragraphs. The following units either provide information to, or act as an interface for, the TCS:

- a. AN/FPN-54A Loran Timing Set(s) (MPT, PCI, LI, 100 kHz, PC Set, PC Reset).
- b. Current Transformer, Pearson Model 1705 (antenna and dummy load RF).
- c. Status Alarm Unit (displays alarm information).
- d. Time Interval Counter Panel (displays timing information).
- e. Transmitter/coupler (allows for remote/local control).

3.2 Controls and Indicators.

3.2.1 Switch Assembly. The Switch Assembly (Figure 3.1) contains the following controls:

REFERENCE	DESIGNATION	DESCRIPTION
1	EMERGENCY STOP SWITCH	These switches (S1 for transmitter #1, S2 for transmitter #2) provide for the shutdown of power to the transmitters to prevent injury to personnel or damage to equipment. The switches are connected in series with other emergency stop switches located on the station. The switch is reset by the activation of the transmitter START button.

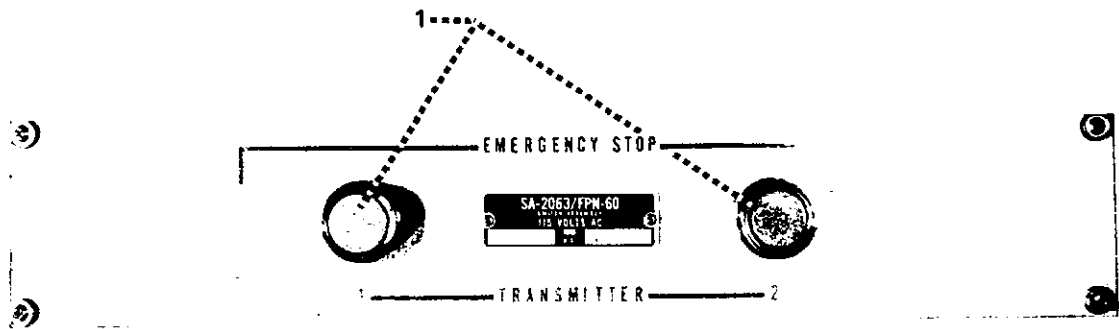


Figure 3.1. Switch Assembly

3.2.2 Transmitter Coupler Control. The following is a list of the controls and indicators of the TCC (see Figure 3.2):

REFERENCE	DESIGNATION	DESCRIPTION
1	SWITCH TRANSMITTERS switch/lamp (S1)	Activation of this pushbutton switch remotely switches the transmitters. When illuminated, this lamp is amber.
2	AUTOMATIC CONTROL lamp (DS1)	This lamp indicates that the transmitter switching function is controlled by the TCC. When illuminated, this lamp is green.
3	TRANSMITTER 1 OPERATE/STANDBY (DS2)	These lamps indicate whether Transmitter 1 is coupled to the antenna or is in a ready state, with the associated PGEN(s) providing TDW(s). When illuminated, OPERATE is green and STANDBY is white.
4	OFF AIR lamp (DS6)	This lamp indicates the failure of the operate PGEN(s) or that the transmitted signal is below the prescribed antenna current level. This lamp is normally off. When illuminated, this lamp is red.
5	Audio alarm	This audio alarm sounds when a TRANSMITTER FAILURE, OFF AIR, or LOW POWER indication is observed. This alarm is normally off.
6	LAMP TEST switch/lamp (S4)	Activation of this pushbutton switch tests all the lamps/LEDs of the TCC and PGENs. When illuminated, the lamp is yellow.

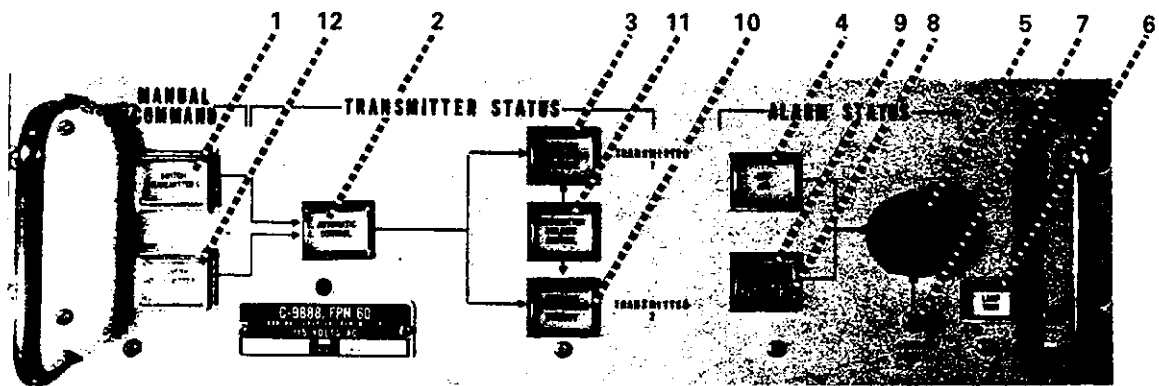


Figure 3.2. TCC Controls and Indicators

REFERENCE	DESIGNATION	DESCRIPTION
7	AUDIO RESET (S3)	This pushbutton switch secures the audio alarm.
8	LOW POWER lamp (DS5)	This lamp indicates a transmitter low power or PGEN low drive level condition that occurred prior to a transmitter switch. This lamp is normally off. When illuminated, this lamp is red.
9	TRANSMITTER FAILURE lamp (DS5)	This lamp indicates the failure of the standby PGEN(s), or that the operate transmitter has been off air for at least 30 seconds, or that the standby transmitter is not in a ready status. This lamp is normally off. When illuminated, this lamp is red.
10	TRANSMITTER 2 OPERATE/STANDBY (DS4)	These lamps indicate whether Transmitter 2 is coupled to the antenna or is in a ready state, with the associated PGEN(s) providing TDW(s). When illuminated, OPERATE is green and STANDBY is white.
11	TRANSMITTER BUILDING CONTROL lamp (DS3)	This lamp indicates that the transmitter switching function is controlled from the transmitter building. When illuminated, this lamp is yellow.

REFERENCE	DESIGNATION	DESCRIPTION
12	STANDBY TRANSMITTER B+ switch/lamp (S2)	This pushbutton switch is used to energize or de-energize the standby transmitter's B+ voltage. If the standby transmitter is not in a ready status, the B+ voltage cannot be energized. When illuminated, the lamp is yellow.

3.2.3 Electrical Pulse Analyzer. The following are the controls and indicators of the EPA (see Figure 3.3):

REFERENCE	DESIGNATION	DESCRIPTION
1	RATE SELECT switch (S1)	This switch is provided for use at dual-rated stations. At single-rated stations, actuation of the switch does not affect operation.
2	SAMPLE NUMBER switch (S3)	This is a three digit thumb-wheel switch. The pulse number to be sampled is selected by the setting of the left most thumbwheel. The half-cycle number is selected by the setting of the center and right thumbwheels.
3	Local control indicator (DS1)	This indicator is illuminated (yellow) when the EPA is in local control. This indicator is normally on.
4	PEAK (VOLTS) (DS3)	This indicator is illuminated (green) when a peak voltage measurement is being displayed.
5	Display	This DPM displays the value of the quantity measurement.
6	ECD (μ sec) (DS4)	This indicator is illuminated (green) when an ECD measurement is being displayed.
7	PEAK/ALTERNATE/ECD switch (S6)	This toggle switch provides for a selection of the quantitative value of the pulse or half-cycle peak voltage samples. The results are displayed on the Digital Panel Meter. The switch can be set to PEAK (measures peak amplitude in volts), ECD (takes average of

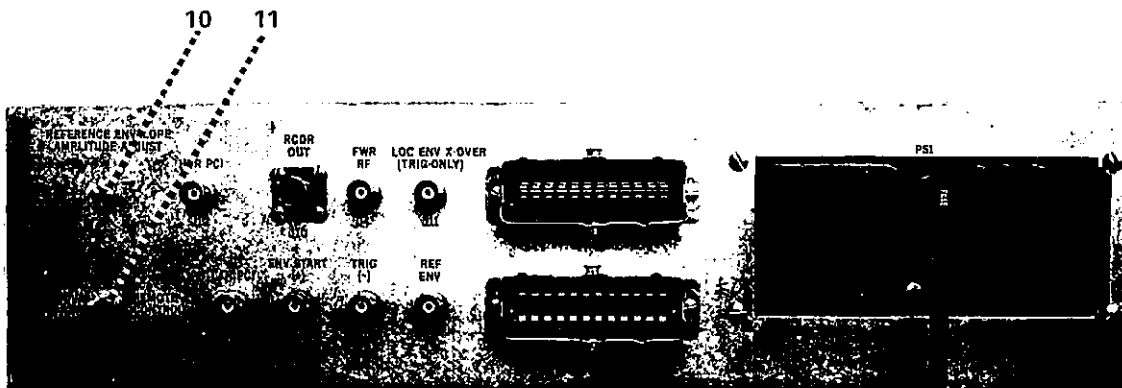
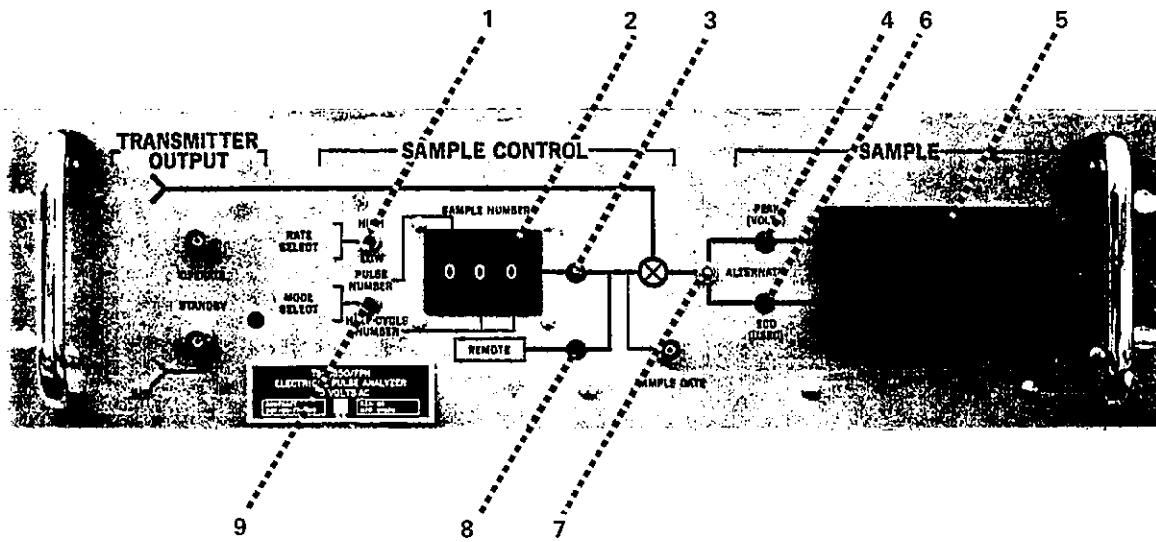


Figure 3.3. EPA Controls and Indicators

REFERENCE	DESIGNATION	DESCRIPTION
		first pulse and third pulse (for master) or seventh pulse (for secondary) in uSec or ALTERNATE (alternates between the two). The ALTERNATE and ECD (uSec) settings result in a blank SAMPLE display unless the MODE SELECT switch is in the PULSE NUMBER position.
8	REMOTE control indicator (DS2)	This indicator is illuminated (green) when the EPA is in remote control. This indicator is normally off.
9	MODE SELECT switch (S2)	This switch is a two-position toggle switch which selects between PULSE NUMBER and HALF-CYCLE NUMBER mode of operation. In the PULSE NUMBER position, the SAMPLE display indicates peak voltage or ECD of the pulse selected, depending on the position of the PEAK/ALTERNATE/ECD switch. In the HALF-CYCLE NUMBER position, the SAMPLE display indicates the peak voltage of the half-cycle of the pulse selected by the SAMPLE NUMBER thumbwheel switch. The PEAK/ALTERNATE/ECD switch must be placed in the PEAK voltage position when the mode switch is in the HALF-CYCLE position.
10	REFERENCE ENVELOPE AMPLITUDE ADJUST	This is a potentiometer on the rear of the EPA that allows the adjustment of the amplitude of the Reference Envelope signal available at J9. Refer to Figure 5.18 for the adjustment of this potentiometer.
11	FRONT PANEL CONTROL/ REMOTE CONTROL switch (S5)	This switch is on the rear of the EPA and selects EPA control via either the front panel or remote control.

3.2.4 Pulse Generator. The following is a list of the controls and indicators of the PGEN (see Figure 3.4):

REFERENCE	DESIGNATION	DESCRIPTION
1	1st MPT (NON Ø CODED) 2nd MPT (Ø CODED) switch (S1)	This two position toggle switch is used to select the oscilloscope trigger for the SCOPE TRIGGER jack on the front panel. The selectable triggers are the first MPT or the second MPT.
2	PULSE SYNTHESIZER switches (S2)	The PULSE SYNTHESIZER switches are used to adjust the amplitude of the sixteen half-cycles of the Transmitter Drive Waveform or of the eight full cycles (using the first eight thumbwheel switch sections from the left) of the Transmitter Drive Waveform. The S1 switch on the PCON module is used to select half-cycle or full cycle control.
3	Ø CODE BALANCE potentiometer	This potentiometer is used to minimize the amplitude variation (bounce) in alternating phase-coded pulses.
4	ALARM - NO TRANSMITTER DRIVE (DS2)	This light emitting diode (red) illuminates when the TDW signal level falls below 1 volt peak-to-peak.
5	TRANSMITTER DRIVE ADJUST	This potentiometer is used to adjust the amplitude of the Transmitter Drive Waveform (TDW).
6	OPERATE (DS1)	This light emitting diode (green) indicates that the PGEN is supplying the drive signal to the transmitter.
7	DROOP switches (S3)	This seven section thumbwheel switch is used to adjust the amplitude of the second through the eighth pulses. This switch is not used with the Group Droop module (set all switches to "0").

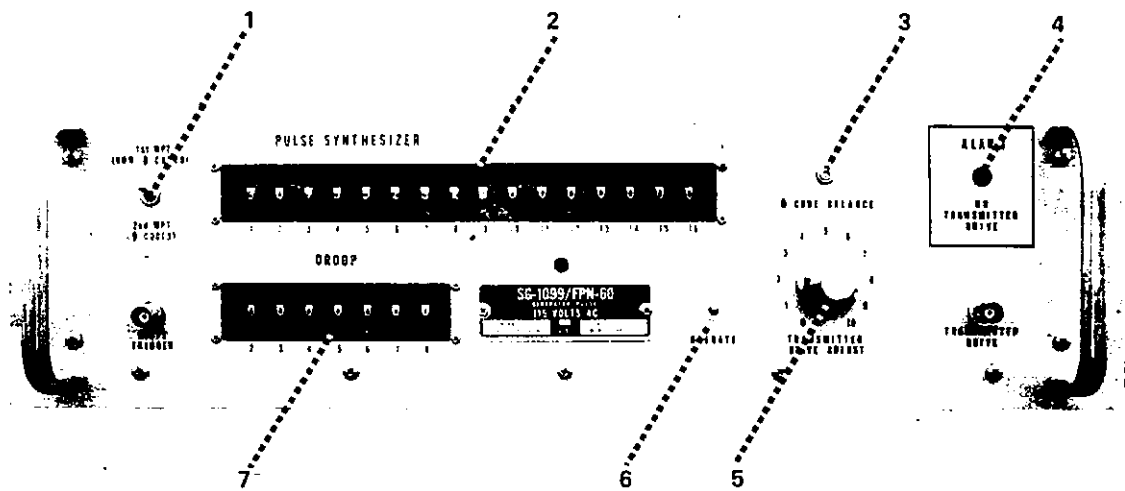


Figure 3.4. PGEN Controls and Indicators

3.2.5 Waveform Panel. The Waveform Panel (Figure 3.5) has the following control:

REFERENCE	DESIGNATION	DESCRIPTION
1	SCOPE TRIGGER switch	This switch allows for the selection of the oscilloscope trigger for the high or low rate signal(s).

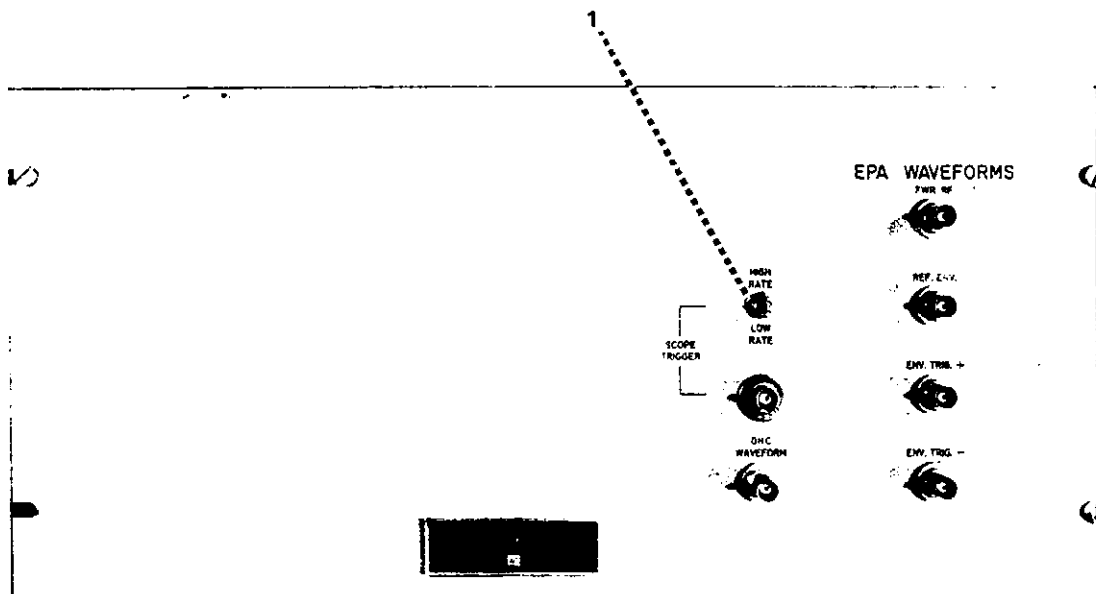


Figure 3.5. Waveform Panel Control

3.3 Operating Procedures. Ensure that all units of the TCS are installed in the cabinet and all programming and operational checks have been made prior to performing any steps in the following paragraphs.

3.3.1 Equipment turn-on. The TCC, EPA, and PGENS are turned on by plugging the power cords into the power strip in the electrical equipment cabinet.

3.3.2 Modes of operation. The TCS has only the local mode of operation.

3.3.2.1 Pulse shape monitoring. Refer to Figure 3.6 and the following steps to monitor the pulse shape:

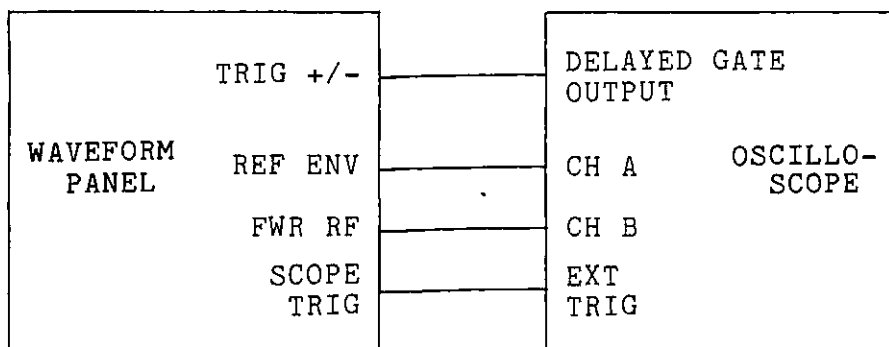


Figure 3.6. Equipment Setup for Pulse Shape Monitoring

- a. Set vertical Channels A and B to 0.5 volts per division.
- b. Set the oscilloscope to External Trigger mode, Display Trigger Source to alternate, and Time Base to 1 millisecond per division.
- c. Using the Delay Vernier Control, set the Reference Envelope waveform on the pulse to be checked.
- d. With the Reference Envelope set on the desired pulse, set the Delay Sweep Control to 10 microseconds per division.
- e. The amplitude of the Reference Envelope may be adjusted by the Reference Amplitude Adjust potentiometer on the rear of the EPA.

3.3.2.2 Pulse amplitude monitoring. Refer to Figure 3.7 and the following steps to monitor the pulse amplitude:

- a. Set vertical Channel A to 2 volts per division.
- b. Set vertical Channel B to 5 volts per division.

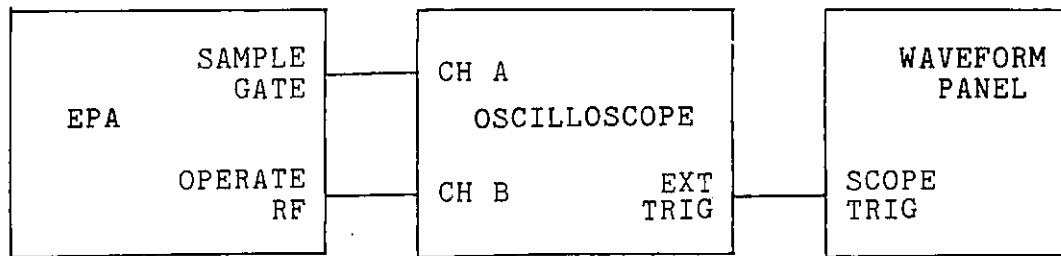


Figure 3.7. Equipment Setup for Pulse Amplitude Monitoring

c. Connect the Waveform Panel Scope Trigger jack to the external Trigger input of the oscilloscope. Set the PEAK/ALTERNATE/ECD switch to ALTERNATE.

d. Set the MODE SELECT switch to the Pulse Number position.

e. Set the left-hand thumbwheel of the SAMPLE NUMBER switch to the number of the desired pulse.

f. Set the oscilloscope Time Base to 1 millisecond per division.

g. As the SAMPLE NUMBER switch is changed, the Sample Gate will move across the oscilloscope to the corresponding pulse, and the peak voltage/ECD will alternately be displayed.

3.3.2.3 Half-cycle amplitude monitoring. Refer to Figure 3.8 and the following steps to monitor the half-cycle amplitude:

a. Set vertical Channel A to 2 volts per division.

b. Set vertical Channel B to 5 volts per division.

c. Connect the Waveform Panel SCOPE TRIGGER jack to the External Trigger input of the oscilloscope.

d. Set the EPA PEAK/ALTERNATE/ECD switch to PEAK (VOLTS).

e. Set the EPA MODE SELECT switch to the HALF-CYCLE position.

f. Set the EPA SAMPLE NUMBER switch to the desired half-cycle number.

g. As the SAMPLE NUMBER switch is changed, the Sample Gate will move across the scope to the corresponding half-cycle.

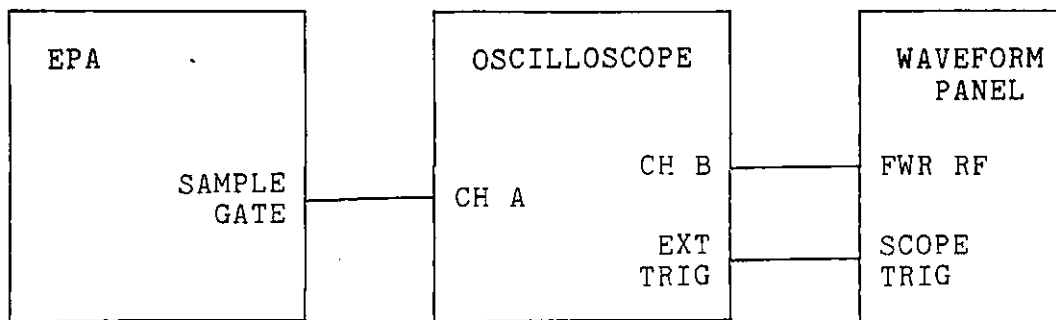


Figure 3.8. Equipment Setup for Half-Cycle Amplitude Monitoring

3.3.2.4 Droop and Phase Code monitoring. Refer to Figure 3.9 and the following steps to monitor droop and phase code:

- a. Connect the Waveform Panel SCOPE TRIGGER jack to the External Trigger input of the oscilloscope.
- b. Set vertical Channel A to 5 volts per division.
- c. Set the oscilloscope Time Base to 1 millisecond per division.

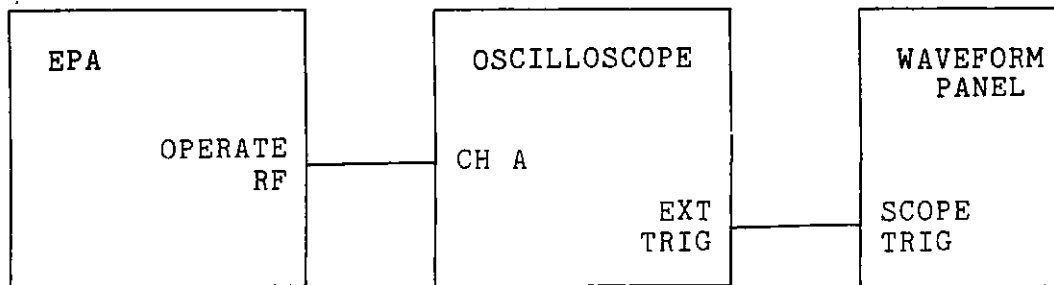


Figure 3.9. Equipment Setup for Droop and Phase Code Monitoring

3.3.3 Equipment turn-off. The TCC, EPA, and PGENs are secured by removing the plugs from their electrical receptacles. The power to the cabinet is secured at the wall circuit breaker.

3.3.4 Emergency turn-off. In the event of an emergency, power to the TCS equipment can be secured at the wall circuit breaker.



CHAPTER 4

THEORY OF OPERATION

4.1 Introduction. The Transmitter Control Set (TCS) receives signals from the Loran Timing Set(s), processes these signals, and generates the drive signals for the transmitters. The TCS monitors the Operate RF and the status of the transmitters, and provides a means of emergency shut down of the transmitters. The TCS also displays various alarm information for the station watchstander. Figure 7.1 shows the Loran-C System Block Diagram. Figure 7.2 shows the Transmitter Control Set Functional Block Text Diagram.

4.2 Functional Description.

4.2.1 Switch Assembly. There is a normally closed, manually actuated, pushbutton switch on this panel for each transmitter. The switches are connected in series with the transmitter stop and emergency stop switches in the associated transmitting equipment (refer to applicable transmitting set technical manual for location). Depressing a switch interrupts the control voltage to the holding coil of the transmitter blower control relays (refer to applicable transmitting set technical manual). The switches are used to secure power to the transmitters to prevent injury to personnel or damage to equipment.

4.2.2 Transmitter Coupler Control. The TCC monitors the Operate RF and the status of the transmitters. With the standby transmitter in a ready status, the standby PGEN(s) providing drive waveform(s), and the antenna coupler in remote control, the TCC controls the switching of the transmitters. When the TCC detects a drop below a preset level of the Operate RF or an operate PGEN failure, the TCC will automatically switch transmitters. Otherwise, the switching of transmitters is accomplished by the actuation of the SWITCH TRANSMITTERS switch. The standby transmitter's B+ voltage is controlled by the TCC when the antenna coupler is in remote control. The TCC displays OFF AIR, TRANSMITTER FAILURE, and LOW POWER conditions.

4.2.3 Electrical Pulse Analyzer. The EPA displays half-cycle amplitude, pulse amplitude, and ECD information. The EPA receives signals from the I/F Unit and Loran Timing Set(s). The EPA also receives an oscilloscope (via the Waveform Panel) trigger, which is used to generate the Reference Envelope. The EPA provides for oscilloscope viewing of a Local Envelope Crossover trigger, a Full Wave Rectified RF, a Reference Envelope, and RF signals.

4.2.4 Pulse Generator. The PGEN generates the drive signal required by the transmitter in order to radiate the standard LORAN-C pulse. The drive signal shape is adjustable by the 16-section PULSE SYNTHESIZER digital thumbwheel switch. The PGEN also controls droop compensation and phase code balance. Another output of the PGEN is an oscilloscope trigger.

4.2.5 Waveform Panel. The Waveform Panel provides a convenient access to the Full Wave Rectified RF, the Reference Envelope, and a Scope Trigger. The Envelope Triggers (+ and -) are inputs to the Waveform Panel which are used by the EPA to develop the Reference Envelope. The Waveform Panel has an "optional" waveform jack that is not used.

4.2.6 Interface Unit. The Interface Unit is an interface between the transmitters and the Loran Timing Set(s). The Interface Unit receives signals from the PGENs, TCC, Switch Assembly, Loran Timing Set(s), and current transformers. Signals are passed to the transmitters, PGENs, EPA, TCC, and Status Alarm Unit.

4.3 Unit Description.

4.3.1 Transmitter Coupler Control (see Figure 7.14).

4.3.1.1 W0678-5/XMTR CON module (see Figure 7.16). The TTL active low Transmitter 1 & 2 Operate, Transmitter 1 & 2 Ready & Ready, Remote and Local signals are inputs to the Transmitter Status section on this module. These signals are inputs to set-reset circuits, and become active high signals. The transmitter operate signals are then routed to the Status Steerage, Loss of Signal Detector, and Transmitter Selector sections and the W0678-6/XMTR CON DVR module. The loss of transmitter drive alarms from the PGENs and Operate RF are inputs to the Loss of Signal Detector section. In this section, these signals are compared to detect an off air condition and triggers the timer chip to start counting the 30 seconds before a transmitter failure condition is indicated. This 30 second time period is to prevent a transmitter switch as a result of a transient overload condition. At single-rated stations, the PGEN I & II High Rate lines are tied to ground. The Initialize section resets the OFF AIR and TRANSMITTER FAILURE circuits on power up or a transmitter switch. The actuation of the standby transmitter's B+ switch turns on the standby transmitter's B+ voltage via the W0678-6/XMTR CON DVR module and the W0678-13/Relay Assembly. The transmitter (from the Transmitter Status section) and PGEN (from the Loss of Signal Detector section) signals are inputs to the Status Steerage section. This section generates alarm condition signals and signals for the lamp driver circuits on the W0678-6/XMTR CON DVR module. Outputs of this section are inputs to the Visual Alarm Generator, Audio Alarm Generator, and Interrupt Timer Start sections. Other outputs of the Status Steerage section are signals to the TRANSMITTER 1 STANDBY and TRANSMITTER 2 STANDBY lamp driver circuits on the W0678-6/XMTR CON DVR module. Outputs from the Loss of Signal Detector, Status Steerage, and Interrupt Timer Start sections are used in the Visual Alarm Generator section to generate the signals for the TRANSMITTER FAILURE and LOW POWER circuits, in the W0678-6/XMTR CON DVR module. The LOW POWER signal becomes active when the TCC is in remote control and a switch has been made to a transmitter which has low PGEN drive, but not an alarm condition. In the Audio Alarm Generator section, when the transmitter is in local control, the Audio alarm sounds when the LOW POWER and TRANSMITTER FAILURE circuits are enabled. When the transmitter is in remote control, the Audio alarm sounds when the TRANSMITTER FAILURE circuit is enabled. The Loss of Signal Detector, Status Steerage, and Manual Transmitter Command sections input signals to the Interrupt Timer Start section. The output of this section triggers the 8 Second

Interrupt Timer section, generating an eight second delay in switching transmitters. During this eight second delay, the high voltage in the standby transmitter is brought up to the proper level. This delayed signal is an input to the W0678-6/XMTR CON DVR module and the Transmitter Selector section. The SWITCH TRANSMITTERS switch on the front panel controls the inputs to the Manual Transmitter Command section. The Transmitter Selector section inputs are the Remote and Operate signals from the Transmitter Status section, the 8 second delayed signal from the 8 Second Interrupt Timer section, and the Initialize signal. This section generates the Latch and Reset signals for the W0678-6/XMTR CON DVR module and Standby B+ Control section of this module. The STANDBY TRANSMITTER B+ switch on the front panel provides the other inputs to the Standby B+ Control section. The output turns on/off the standby transmitter's B+ voltage, when the TCC is displaying AUTOMATIC CONTROL.

4.3.1.2 W0678-6/XMTR CON DVR (see Figure 7.18). This module contains nine lamp drivers, one alarm driver, and four relay driver circuits. Each circuit generates two outputs. One output latches or resets a relay, lights a lamp, or sounds an alarm. The other output is provided for computer control. The computer control outputs are not presently used. The inputs to the circuits are generated on the W0678-5/XMTR CON module. The C-LDR-2 and C-LDR-5 Lamp Drivers also have inputs from the respective Relay Drivers. The LAMP TEST switch on the front panel also activates the lamp drivers and the alarm driver.

4.3.1.3 W0678/Relay Assembly (see Figure 7.15). The Relay Assembly acts as a DC/AC convertor for the signals to the transmitter from the TCC and as an AC/DC convertor for the signals to the TCC from the transmitter. The signals from the TCC, to switch the transmitters, are sent through relays K1 and K3. Relay K3 is a latching relay that is used to place the transmitters in remote or local control. Relays K4 through K7 are the AC/DC converting relays. The Xmtr No. 1 & 2 Ready and Xmtr No. 2 Operate AC signals are sent to the TCC through these relays.

4.3.2 Electrical Pulse Analyzer (see Figure 7.20).

4.3.2.1 W0678-3A/GATCON module (see Figure 7.22). Local Interval (high and low rate) and Remote and Local Rate Select signals are inputs to the Rate Select Circuit section of this module. The Local and Remote Rate Select signals are used to generate the Rate Select signal. The Rate Select and Local Interval signals are used to generate the Strobe Enable and Initiate Sequence signals. Local Mode Select, Local/Remote Select, and Remote Mode Select signals are routed to the Mode Select Circuit section to generate the Mode Select signal. The $\frac{1}{2}$ Cycle From Bi-Directional 1-Shot, Initiate Sequence, $\frac{1}{2}$ Cycle Pulse Select (from ECD module), and Selected MPTs (from ECD module) signals are also sent to the Mode Select Circuit section. The Count Waveform is generated from these signals. The binary bits of the pulse or half cycle selected for measurement are inputs to the Address Control Circuit section. The Strobe Enable and Relatch signals are sent to this section to transfer the binary bit information to the Data Strobe Generator section. Inputs to the Data Strobe Generator section (Count Waveform, Pulse/ $\frac{1}{2}$ Cycle/(Remote) Select, Strobe Enable,

Initiate Sequence, and binary bits from the Address Control Circuit section) are used to generate the Data Strobe signal (see Figure 5.22). Data Strobe occurs once each interval and corresponds in time to the particular pulse (or half-cycle of the pulse) selected by the SAMPLE NUMBER switches. Sixty-four Data Strobes are generated prior to the start of the DPM measurement. Mode Select, Rate Select, and a trigger from the Address Control Circuit section are used to generate the Relatch signal in the Data Control Circuit section. Also generated in this section are Convert (for the DPM to start measurement), Data Ready (not used), ECD/VP Toggle (for the ECD module), and Peak Detector Reset (see Figure 5.21), from Initiate Sequence, FOC, EOC, Relatch, and the divide-by-64 output signals. The divide-by-64 circuit is used to count the sixty-four Data Strobes generated on this module.

4.3.2.2 W0678-18C/ECD module (see Figure 7.24). The ATTN RF from the W0678-11A/CLP ATTN module enters the RF Deriver section of the ECD module, which is an active allpass filter-and-add. This filter-and-add produces a derived LORAN-C pulse having an amplitude null and a phase reversal on the leading edge. This occurs at 18 microseconds after the start of a pulse having an ECD of zero. The ATTN RF is also hardlimited in the Pulse Hard Limiter section. The resulting TTL signal is used to gate the programmable amplifier of the RF Detector section and to synchronously detect the derived pulse. The detected signal enters a two-pole lowpass active filter with 11 kHz cutoff, which smooths the signal, to form a derived envelope (see Figure 5.27). This derived envelope is initially negative, crossing zero at forty microseconds, then becoming positive, for a zero ECD pulse. The Envelope Hard Limiter section converts the derived envelope to TTL levels; low before the crossover and high after. The hardlimited envelope is outputted at pin 51 of the module, where it is "wire ANDed" with the Clip Attenuator Gate generated on the W0678-11A/CLP ATTN module. The "ANDed" signal is jumpered to the Envelope Start Cycle Stop Generator section via pin 42 of the ECD module. On the pulse selected by the Sample Strobe Generator, MPT Count and Select, and PCI Synchronizer sections; the Envelope Start Cycle Stop Generator section generates a Local Envelope Crossover trigger, which goes high at the crossover and returns low at the next RF zero crossing. The ECD Voltage Generator section converts the 0 to 10 microsecond pulse width of the trigger (which corresponds to an ECD of -5 to +5 microseconds) to a -5 to +5 volt level to drive the Digital Panel Meter via the DPM Combiner Driver section. This level is also shifted and scaled to provide a chart recorder drive signal of either 0 to 1 milliamper or 0 to 5 volts full scale. The DPM Combiner Driver section selects either the ECD or pulse peak voltage for display by the DPM, scales the DPM voltage to a range of -1 to +1 volts, sets the decimal point location on the DPM, and lights the ECD (μ sec) or PEAK (VOLTS) indicators, as controlled by the PEAK/ALTERNATE/ECD switch. The center position (ALTERNATE) of this switch allows the ECD/VP Toggle waveform from the W0678-3A/GATCON module to toggle the state of this section and alternately display ECD and peak volts. The high-going Initiate Sequence signal from the W0678-3A/GATCON module enables the MPT Count and Select section to count the MPTs from the start of PCI interval A of the selected rate. The MPT Count and Select section also enables the Sample Strobe Generator section to initiate an ECD measurement on the first pulse of PCI interval B (positive phase code) and the nega-

tively coded seventh pulse (secondary) or third pulse (master) of PCI interval A. The grounding of E4 or E5 to E3 programs, respectively, the HI or LOW rate for master. A selected MPT corresponding to the setting of the pulse number, on the SAMPLE NUMBER switch, is output to the Peak Detector module.

4.3.2.3 W0678-4/PK DET module (see Figure 7.26). In response to an externally applied trigger (positive or negative), the Reference Envelope Generator section generates the adjustable Reference Envelope waveform. A Clipped RF signal from the W0678-11A/CLP ATTN module is sent to one of the active two-pole Butterworth low-pass filters. The output of this filter is a clipped filtered RF of 10V positive and 8V negative amplitude. This clipped filtered RF is sent to the Tri-State Discriminator section. This section generates two hardlimited RF signals (180 degrees out-of-phase) to control the Fullwave Rectifier section. The Count Waveform (see Figure 5.30) and the Count Waveform (for the Peak Detect and Hold section) are also outputs of the Tri-State Discriminator section. These outputs consist of a hard limited signal of +4V amplitude. An Operate RF (Attenuated) from the W0678-11A/CLP ATTN module is sent to the other low-pass filter on this module. The output of this filter is a filtered attenuated RF of 6V positive and 8V negative amplitude. This signal is then sent to the Fullwave Rectifier section. A full wave rectified RF is developed in this section and is sent to the Peak Detect and Hold section. This full wave rectified RF is also fed through a voltage follower (buffered), then is sent to the EPA rear panel jack, J4. The Peak Detect and Hold section generates a Sample Gate signal from the Data Strobe, Peak Detector Reset, and Count Waveform signals. This section also uses an inverted Sample Gate signal, a full wave rectified RF (from the Fullwave Rectifier section), and the Peak Detector Reset signal to detect and hold the peak value of the full wave rectified RF during the sample period. This DC level (see Figure 5.29) is then sent to the W0678-18C/ECD module.

4.3.2.4 W0678-11A/CLP ATTN module (see Figure 7.28). The resistors and potentiometer in the Attenuator section provide passive attenuation of the Operate RF and a means of calibrating the DPM. In the Limiter section of this module are five resistors (R1, R2, R3, R7, and R8). Four of these resistors (R1, R2, R3, and R8) are used to limit the current through the front panel LED indicators (DS1 through DS4). R7 forms a voltage divider with R1, located on the EPA rear panel. When the Operate RF input to the EPA exceeds 30V peak-to-peak, the Clipper section of the W0678-11A/CLP ATTN module clips the operate RF to 30V peak-to-peak. The Selected MPTs signal from the W0678-18C/ECD module is sent to the Delay Gate Generator section. In this section, a 15 sec gate (see Figure 5.31) is generated and coupled to the output of the Envelope Hard Limiter section of the W0678-18C/ECD module. This is done to ensure that spurious transitions of the hardlimited envelope cannot cause erroneous ECD indications.

4.3.2.5 Digital Panel Meter. Upon receipt of the Convert signal from the W0678-3A/GATCON module, peak volts or ECD analog voltages received from the W0678-18C/ECD module are measured. The DPM converts and displays the peak volts or ECD on a three-and-a-half digit panel display. After the DPM completes the conversion, it sends an EOC signal to the W0678-3A/GATCON module.

4.3.3 Pulse Generator (see Figure 7.30).

4.3.3.1 W0678-1/PSYN module (see Figure 7.32). The Multiplying Digital to Analog Converter section of this module receives the 100-kHz sine wave input from the timer set. Data control words from the Cycle Data Control section of the Pulse Control module are also inputs to the Multiplying Digital to Analog Converter section. These control words control the amplitude of the individual 100-kHz cycles. The output of this section is a preshaped version of the Transmitter Drive Waveform. This waveform is an input to the Switched Inverting Amplifier section, where it is phase coded. Phase code balance is provided via the front panel \emptyset CODE BALANCE potentiometer, which provides an amplitude balance between the positive and negative half cycles. The output is a phase coded signal, which along with data control words from the Pulse Data Control section of the Pulse Control module are inputs to the Gain Control Amplifier section. This section acts as a multiplying analog-to-digital converter to provide pulse droop compensation and an ungated, amplitude modulated Transmitter Drive Waveform (TDW) is outputted. This signal is buffered in the Amplifier section and output to the front panel TRANSMITTER DRIVE potentiometer via the W0678-19B/GR DROOP module (at single-rated stations, the signal is output directly to the front panel). The signal returns to the Amplifier section where it is again buffered, then enters the Gating Power Amplifier section. This section controls the start of the TDW by using the 500- μ sec Gate-H and Gate-L signals from the Tail Gate Generator section of the W0678-19B/GR DROOP module. The timing of the Gate-H and Gate-L signals is controlled by the Envelope Timing Adjust (ETA) switch on the timer or Remote Control Interface (RCI) by controlling the MPT timing. This section outputs a balanced Transmitter Drive Waveform to the transmitters via the Interface Unit, and signals to the Lost Signal Detector section (see Figures 5.34 and 5.35). A loss of the drive waveform generates a No Transmitter Drive signal to the TCC and will light the ALARM-NO TRANSMITTER DRIVE LED on the front panel of the PGEN. The Transmitter 1 & 2 Operate and Lamp Test signals are also inputs to the Lost Signal Detector section. These signals light the correct LED (ALARM or OPERATE).

4.3.3.2 W0678-19B/GR DROOP module (see Figure 7.34). The MPTs of both rates are inputs to the Droop Generator and Filter section. The programming (paragraph 2.6.2) and adjustments (paragraph 2.7.2) of the low pass filters generate the droop compensating waveforms in this section. Pulse droop compensation is produced by using the rate of interest MPTs. The other rate MPTs are used to produce a dynamic compensation waveform as the two rates move with respect to each other. The droop compensating waveforms are inputs to the Group Droop Summing Amplifier section. This section produces a 1-volt reference level and sums the compensating waveforms with the 1-volt reference level to produce a composite, compensation waveform (see paragraph 2.7.2). Inputs to the Tail Gate Generator section are Local Interval and the 80- μ sec Gate-L signal from the Control section of the W0678-2/PCON module. The 80- μ sec Gate-L signal is used to generate two 500- μ sec gates (Gate-H, Figure 5.36, and Gate-L) used by the Gating Power Amplifier section of the W0678-1/PSYN module. The 500- μ sec Gate-L signal and Local Interval are used to generate a tail gate signal for the Pulse Tail Generator section of this module. This section uses the tail gate signal to superimpose an exponentially decaying, tail

shaping waveform on the composite, compensation waveform from the Group Droop Summing Amplifier section. The decay time constant is varied by the adjustment of R25. This signal is used to modulate the ungated, amplitude modulated TDW in the Hundred Kilohertz Modulator section. This provides dynamic droop compensation and a controlled tail for the drive pulses. The 500- μ sec Gate-L signal and the Phase Code-H signal from the Phase Code Control section of the W0678-2/PCON module are used to produce a Reclocked Phase Code-H signal in the Phase Code Reclock section. This signal is an input to the Switched Inverting Amplifier section of the W0678-1/PSYN module. Also present on this module is the Deccajector Summing Amplifier section. This section is only wired for use on the W0686-20/GR DROOP module. The Deccajector Summing Amplifier section sums the deccajector outphasing signals with the 100 kHz used to produce the drive waveform. This prevents interference to DECCA navigation equipment by LORAN-C transmitters.

4.3.3.3 W0678-2/PCON module (see Figure 7.36). The Local Interval (see Figure 5.40), 100-kHz sine wave (see Figure 5.39), and MPT-H (see Figure 5.46) signals are inputs to the Control section of this module. These inputs are used to generate the Gate-L and Gate-H signals. At single-rated stations not employing tail drive, both signals are inputs to the W0678-1/PSYN module. At dual-rated stations, the 80- μ sec Gate-H signal is not used, and the 80- μ sec Gate-L signal is a W0678-19B/GR DROOP module input. The switch, S1, allows for the selection of half drive cycle or full drive cycle control with the PULSE SYNTHESIZER thumbwheel switches. A threshold detector is used to determine the zero crossing of the 100-kHz sine wave. This is used to generate a timing control waveform for the Cycle Selection section. This section uses the timing control waveform to select the front panel PULSE SYNTHESIZER switch digit to be read. The Pulse Selection section uses the timing control waveform to select the proper front panel DROOP switch digit. The Cycle Data Control section has inputs from the PULSE SYNTHESIZER thumbwheel switches and outputs data control words to the Multiplying Digital to Analog Convertor section of the W0678-1/PSYN module. The Pulse Data Control section has inputs from the DROOP thumbwheel switches and outputs data control words to the Gain Control Amplifier section of the W0678-1/PSYN module. The Scope Trigger Generator section uses inputs from the Pulse Selection section, the Gate-L signal and the position of the front panel SCOPE TRIGGER switch (S1) to generate a scope trigger from the 1st or 2nd MPT. The Phase Code Control section uses Phase Code Set and Reset (see Figures 5.42 through 5.45) from the Loran Timing Set(s) and the inverted Local Interval from the Control section to generate the Phase Code-H signal for the Phase Code Reclock section of the W0678-19B/GR DROOP module (at stations with tail drive). At stations without tail drive, the Phase Code-H signal is generated for the Switched Inverting Amplifier section of the W0678-1/PSYN module.

4.3.4 Interface Unit (see Figure 7.38). The Interface Unit distributes signals to other units. This unit receives the Operate RF from the Current Transformer through a balanced, 100-ohm, double shielded cable. Two hybrid power splitters receive this signal. One splitter outputs two in-phase RF signals to the Loran Timing Set(s) (for the cycle compensation loop); the EPA and TCC receive an inverted RF signal from the other splitter. If either in-phase output is unused (single-rated operation), it must be terminated in 50 ohms.

4.4 Time-ladder Diagrams. Figures 4.1 and 4.2 are the time-ladder diagrams for master and secondary stations, respectively. The signals are received by the TCS equipment from the Loran Timing Set(s). The Local Interval starts 500 μsec before the first MPT and ends 1,400 μsec after the last MPT. The master station's Local Interval is 10,900 μsec long, and the secondary station's Local Interval is 8,900 μsec long. Phase Coding of the MPTs occur between the Phase Code Reset (starts the negative \emptyset code) and Phase Code Set (starts the positive \emptyset code) pulses.

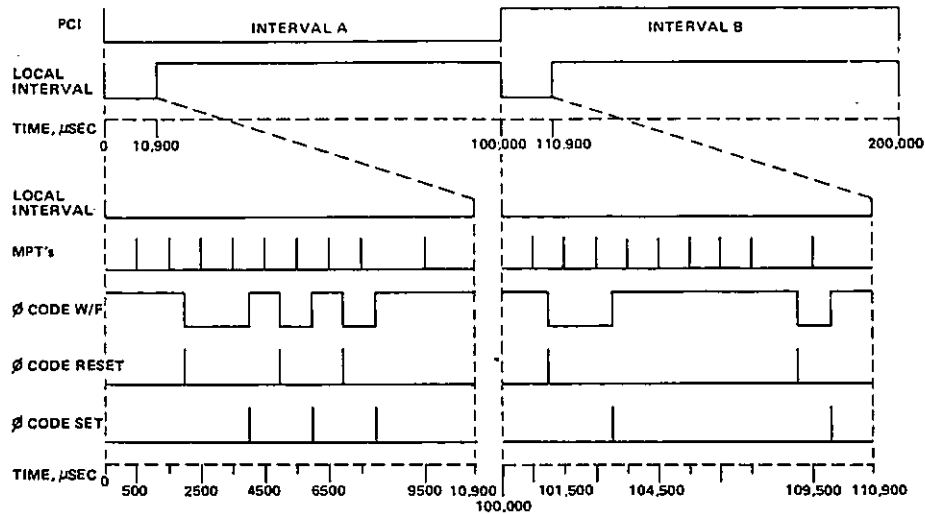


Figure 4.1. Master Station Time-Ladder Diagram
(Non-Existing Rate 10,000)

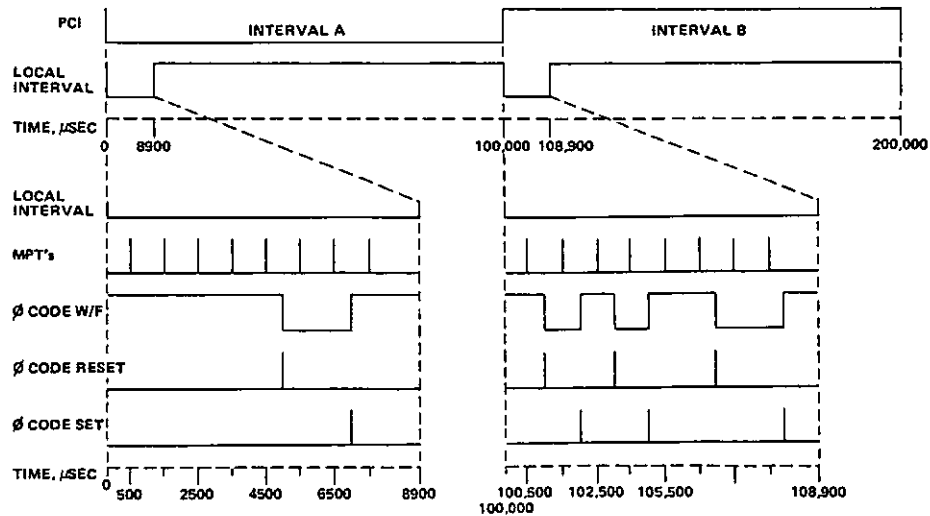


Figure 4.2. Secondary Station Time-Ladder Diagram
(Non-Existing Rate 10,000)

CHAPTER 4

THEORY OF OPERATION

4.1 Introduction. The Transmitter Control Set (TCS) receives signals from the Loran Timing Set(s), processes these signals, and generates the drive signals for the transmitters. The TCS monitors the Operate RF and the status of the transmitters, and provides a means of emergency shut down of the transmitters. The TCS also displays various alarm information for the station watchstander. Figure 7.1 shows the Loran-C System Block Diagram. Figure 7.2 shows the Transmitter Control Set Functional Block Text Diagram.

4.2 Functional Description.

4.2.1 Switch Assembly. There is a normally closed, manually actuated, pushbutton switch on this panel for each transmitter. The switches are connected in series with the transmitter stop and emergency stop switches in the associated transmitting equipment (refer to applicable transmitting set technical manual for location). Depressing a switch interrupts the control voltage to the holding coil of the transmitter blower control relays (refer to applicable transmitting set technical manual). The switches are used to secure power to the transmitters to prevent injury to personnel or damage to equipment.

4.2.2 Transmitter Coupler Control. The TCC monitors the Operate RF and the status of the transmitters. With the standby transmitter in a ready status, the standby PGEN(s) providing drive waveform(s), and the antenna coupler in remote control, the TCC controls the switching of the transmitters. When the TCC detects a drop below a preset level of the Operate RF or an operate PGEN failure, the TCC will automatically switch transmitters. Otherwise, the switching of transmitters is accomplished by the actuation of the SWITCH TRANSMITTERS switch. The standby transmitter's B+ voltage is controlled by the TCC when the antenna coupler is in remote control. The TCC displays OFF AIR, TRANSMITTER FAILURE, and LOW POWER conditions.

4.2.3 Electrical Pulse Analyzer. The EPA displays half-cycle amplitude, pulse amplitude, and ECD information. The EPA receives signals from the I/F Unit and Loran Timing Set(s). The EPA also receives an oscilloscope (via the Waveform Panel) trigger, which is used to generate the Reference Envelope. The EPA provides for oscilloscope viewing of a Local Envelope Crossover trigger, a Full Wave Rectified RF, a Reference Envelope, and RF signals.

4.2.4 Pulse Generator. The PGEN generates the drive signal required by the transmitter in order to radiate the standard LORAN-C pulse. The drive signal shape is adjustable by the 16-section PULSE SYNTHESIZER digital thumbwheel switch. The PGEN also controls droop compensation and phase code balance. Another output of the PGEN is an oscilloscope trigger.

4.2.5 Waveform Panel. The Waveform Panel provides a convenient access to the Full Wave Rectified RF, the Reference Envelope, and a Scope Trigger. The Envelope Triggers (+ and -) are inputs to the Waveform Panel which are used by the EPA to develop the Reference Envelope. The Waveform Panel has an "optional" waveform jack that is not used.

4.2.6 Interface Unit. The Interface Unit is an interface between the transmitters and the Loran Timing Set(s). The Interface Unit receives signals from the PGENs, TCC, Switch Assembly, Loran Timing Set(s), and current transformers. Signals are passed to the transmitters, PGENs, EPA, TCC, and Status Alarm Unit.

4.3 Unit Description.

4.3.1 Transmitter Coupler Control (see Figure 7.14).

4.3.1.1 W0678-5/XMTR CON module (see Figure 7.16). The TTL active low Transmitter 1 & 2 Operate, Transmitter 1 & 2 Ready & Ready, Remote and Local signals are inputs to the Transmitter Status section on this module. These signals are inputs to set-reset circuits, and become active high signals. The transmitter operate signals are then routed to the Status Steerage, Loss of Signal Detector, and Transmitter Selector sections and the W0678-6/XMTR CON DVR module. The loss of transmitter drive alarms from the PGENs and Operate RF are inputs to the Loss of Signal Detector section. In this section, these signals are compared to detect an off air condition and triggers the timer chip to start counting the 30 seconds before a transmitter failure condition is indicated. This 30 second time period is to prevent a transmitter switch as a result of a transient overload condition. At single-rated stations, the PGEN I & II High Rate lines are tied to ground. The Initialize section resets the OFF AIR and TRANSMITTER FAILURE circuits on power up or a transmitter switch. The actuation of the standby transmitter's B+ switch turns on the standby transmitter's B+ voltage via the W0678-6/XMTR CON DVR module and the W0678-13/Relay Assembly. The transmitter (from the Transmitter Status section) and PGEN (from the Loss of Signal Detector section) signals are inputs to the Status Steerage section. This section generates alarm condition signals and signals for the lamp driver circuits on the W0678-6/XMTR CON DVR module. Outputs of this section are inputs to the Visual Alarm Generator, Audio Alarm Generator, and Interrupt Timer Start sections. Other outputs of the Status Steerage section are signals to the TRANSMITTER 1 STANDBY and TRANSMITTER 2 STANDBY lamp driver circuits on the W0678-6/XMTR CON DVR module. Outputs from the Loss of Signal Detector, Status Steerage, and Interrupt Timer Start sections are used in the Visual Alarm Generator section to generate the signals for the TRANSMITTER FAILURE and LOW POWER circuits, in the W0678-6/XMTR CON DVR module. The LOW POWER signal becomes active when the TCC is in remote control and a switch has been made to a transmitter which has low PGEN drive, but not an alarm condition. In the Audio Alarm Generator section, when the transmitter is in local control, the Audio alarm sounds when the LOW POWER and TRANSMITTER FAILURE circuits are enabled. When the transmitter is in remote control, the Audio alarm sounds when the TRANSMITTER FAILURE circuit is enabled. The Loss of Signal Detector, Status Steerage, and Manual Transmitter Command sections input signals to the Interrupt Timer Start section. The output of this section triggers the 8 Second

Interrupt Timer section, generating an eight second delay in switching transmitters. During this eight second delay, the high voltage in the standby transmitter is brought up to the proper level. This delayed signal is an input to the W0678-6/XMTR CON DVR module and the Transmitter Selector section. The SWITCH TRANSMITTERS switch on the front panel controls the inputs to the Manual Transmitter Command section. The Transmitter Selector section inputs are the Remote and Operate signals from the Transmitter Status section, the 8 second delayed signal from the 8 Second Interrupt Timer section, and the Initialize signal. This section generates the Latch and Reset signals for the W0678-6/XMTR CON DVR module and Standby B+ Control section of this module. The STANDBY TRANSMITTER B+ switch on the front panel provides the other inputs to the Standby B+ Control section. The output turns on/off the standby transmitter's B+ voltage, when the TCC is displaying AUTOMATIC CONTROL.

4.3.1.2 W0678-6/XMTR CON DVR (see Figure 7.18). This module contains nine lamp drivers, one alarm driver, and four relay driver circuits. Each circuit generates two outputs. One output latches or resets a relay, lights a lamp, or sounds an alarm. The other output is provided for computer control. The computer control outputs are not presently used. The inputs to the circuits are generated on the W0678-5/XMTR CON module. The C-LDR-2 and C-LDR-5 Lamp Drivers also have inputs from the respective Relay Drivers. The LAMP TEST switch on the front panel also activates the lamp drivers and the alarm driver.

4.3.1.3 W0678/Relay Assembly (see Figure 7.15). The Relay Assembly acts as a DC/AC convertor for the signals to the transmitter from the TCC and as an AC/DC convertor for the signals to the TCC from the transmitter. The signals from the TCC, to switch the transmitters, are sent through relays K1 and K3. Relay K3 is a latching relay that is used to place the transmitters in remote or local control. Relays K4 through K7 are the AC/DC converting relays. The Xmtr No. 1 & 2 Ready and Xmtr No. 2 Operate AC signals are sent to the TCC through these relays.

4.3.2 Electrical Pulse Analyzer (see Figure 7.20).

4.3.2.1 W0678-3A/GATCON module (see Figure 7.22). Local Interval (high and low rate) and Remote and Local Rate Select signals are inputs to the Rate Select Circuit section of this module. The Local and Remote Rate Select signals are used to generate the Rate Select signal. The Rate Select and Local Interval signals are used to generate the Strobe Enable and Initiate Sequence signals. Local Mode Select, Local/Remote Select, and Remote Mode Select signals are routed to the Mode Select Circuit section to generate the Mode Select signal. The $\frac{1}{2}$ Cycle From Bi-Directional 1-Shot, Initiate Sequence, $\frac{1}{2}$ Cycle Pulse Select (from ECD module), and Selected MPTs (from ECD module) signals are also sent to the Mode Select Circuit section. The Count Waveform is generated from these signals. The binary bits of the pulse or half cycle selected for measurement are inputs to the Address Control Circuit section. The Strobe Enable and Relatch signals are sent to this section to transfer the binary bit information to the Data Strobe Generator section. Inputs to the Data Strobe Generator section (Count Waveform, Pulse/ $\frac{1}{2}$ Cycle/(Remote) Select, Strobe Enable,

Initiate Sequence, and binary bits from the Address Control Circuit section) are used to generate the Data Strobe signal (see Figure 5.22). Data Strobe occurs once each interval and corresponds in time to the particular pulse (or half-cycle of the pulse) selected by the SAMPLE NUMBER switches. Sixty-four Data Strobes are generated prior to the start of the DPM measurement. Mode Select, Rate Select, and a trigger from the Address Control Circuit section are used to generate the Relatch signal in the Data Control Circuit section. Also generated in this section are Convert (for the DPM to start measurement), Data Ready (not used), ECD/VP Toggle (for the ECD module), and Peak Detector Reset (see Figure 5.21), from Initiate Sequence, FOC, EOC, Relatch, and the divide-by-64 output signals. The divide-by-64 circuit is used to count the sixty-four Data Strobes generated on this module.

4.3.2.2 W0678-18C/ECD module (see Figure 7.24). The ATTN RF from the W0678-11A/CLP ATTN module enters the RF Deriver section of the ECD module, which is an active allpass filter-and-add. This filter-and-add produces a derived LORAN-C pulse having an amplitude null and a phase reversal on the leading edge. This occurs at 18 microseconds after the start of a pulse having an ECD of zero. The ATTN RF is also hardlimited in the Pulse Hard Limiter section. The resulting TTL signal is used to gate the programmable amplifier of the RF Detector section and to synchronously detect the derived pulse. The detected signal enters a two-pole lowpass active filter with 11 kHz cutoff, which smooths the signal, to form a derived envelope (see Figure 5.27). This derived envelope is initially negative, crossing zero at forty microseconds, then becoming positive, for a zero ECD pulse. The Envelope Hard Limiter section converts the derived envelope to TTL levels; low before the crossover and high after. The hardlimited envelope is outputted at pin 51 of the module, where it is "wire ANDed" with the Clip Attenuator Gate generated on the W0678-11A/CLP ATTN module. The "ANDed" signal is jumpered to the Envelope Start Cycle Stop Generator section via pin 42 of the ECD module. On the pulse selected by the Sample Strobe Generator, MPT Count and Select, and PCI Synchronizer sections; the Envelope Start Cycle Stop Generator section generates a Local Envelope Crossover trigger, which goes high at the crossover and returns low at the next RF zero crossing. The ECD Voltage Generator section converts the 0 to 10 microsecond pulse width of the trigger (which corresponds to an ECD of -5 to +5 microseconds) to a -5 to +5 volt level to drive the Digital Panel Meter via the DPM Combiner Driver section. This level is also shifted and scaled to provide a chart recorder drive signal of either 0 to 1 milliamperes or 0 to 5 volts full scale. The DPM Combiner Driver section selects either the ECD or pulse peak voltage for display by the DPM, scales the DPM voltage to a range of -1 to +1 volts, sets the decimal point location on the DPM, and lights the ECD (μ sec) or PEAK (VOLTS) indicators, as controlled by the PEAK/ALTERNATE/ECD switch. The center position (ALTERNATE) of this switch allows the ECD/VP Toggle waveform from the W0678-3A/GATCON module to toggle the state of this section and alternately display ECD and peak volts. The high-going Initiate Sequence signal from the W0678-3A/GATCON module enables the MPT Count and Select section to count the MPTs from the start of PCI interval A of the selected rate. The MPT Count and Select section also enables the Sample Strobe Generator section to initiate an ECD measurement on the first pulse of PCI interval B (positive phase code) and the nega-

tively coded seventh pulse (secondary) or third pulse (master) of PCI interval A. The grounding of E4 or E5 to E3 programs, respectively, the HI or LOW rate for master. A selected MPT corresponding to the setting of the pulse number, on the SAMPLE NUMBER switch, is output to the Peak Detector module.

4.3.2.3 W0678-4/PK DET module (see Figure 7.26). In response to an externally applied trigger (positive or negative), the Reference Envelope Generator section generates the adjustable Reference Envelope waveform. A Clipped RF signal from the W0678-11A/CLP ATTN module is sent to one of the active two-pole Butterworth low-pass filters. The output of this filter is a clipped filtered RF of 10V positive and 8V negative amplitude. This clipped filtered RF is sent to the Tri-State Discriminator section. This section generates two hardlimited RF signals (180 degrees out-of-phase) to control the Fullwave Rectifier section. The Count Waveform (see Figure 5.30) and the Count Waveform (for the Peak Detect and Hold section) are also outputs of the Tri-State Discriminator section. These outputs consist of a hard limited signal of +4V amplitude. An Operate RF (Attenuated) from the W0678-11A/CLP ATTN module is sent to the other low-pass filter on this module. The output of this filter is a filtered attenuated RF of 6V positive and 8V negative amplitude. This signal is then sent to the Fullwave Rectifier section. A full wave rectified RF is developed in this section and is sent to the Peak Detect and Hold section. This full wave rectified RF is also fed through a voltage follower (buffered), then is sent to the EPA rear panel jack, J4. The Peak Detect and Hold section generates a Sample Gate signal from the Data Strobe, Peak Detector Reset, and Count Waveform signals. This section also uses an inverted Sample Gate signal, a full wave rectified RF (from the Fullwave Rectifier section), and the Peak Detector Reset signal to detect and hold the peak value of the full wave rectified RF during the sample period. This DC level (see Figure 5.29) is then sent to the W0678-18C/ECD module.

4.3.2.4 W0678-11A/CLP ATTN module (see Figure 7.28). The resistors and potentiometer in the Attenuator section provide passive attenuation of the Operate RF and a means of calibrating the DPM. In the Limiter section of this module are five resistors (R1, R2, R3, R7, and R8). Four of these resistors (R1, R2, R3, and R8) are used to limit the current through the front panel LED indicators (DS1 through DS4). R7 forms a voltage divider with R1, located on the EPA rear panel. When the Operate RF input to the EPA exceeds 30V peak-to-peak, the Clipper section of the W0678-11A/CLP ATTN module clips the operate RF to 30V peak-to-peak. The Selected MPTs signal from the W0678-18C/ECD module is sent to the Delay Gate Generator section. In this section, a 15 sec gate (see Figure 5.31) is generated and coupled to the output of the Envelope Hard Limiter section of the W0678-18C/ECD module. This is done to ensure that spurious transitions of the hardlimited envelope cannot cause erroneous ECD indications.

4.3.2.5 Digital Panel Meter. Upon receipt of the Convert signal from the W0678-3A/GATCON module, peak volts or ECD analog voltages received from the W0678-18C/ECD module are measured. The DPM converts and displays the peak volts or ECD on a three-and-a-half digit panel display. After the DPM completes the conversion, it sends an EOC signal to the W0678-3A/GATCON module.

4.3.3 Pulse Generator (see Figure 7.30).

4.3.3.1 W0678-1/PSYN module (see Figure 7.32). The Multiplying Digital to Analog Convertor section of this module receives the 100-kHz sine wave input from the timer set. Data control words from the Cycle Data Control section of the Pulse Control module are also inputs to the Multiplying Digital to Analog Convertor section. These control words control the amplitude of the individual 100-kHz cycles. The output of this section is a preshaped version of the Transmitter Drive Waveform. This waveform is an input to the Switched Inverting Amplifier section, where it is phase coded. Phase code balance is provided via the front panel \emptyset CODE BALANCE potentiometer, which provides an amplitude balance between the positive and negative half cycles. The output is a phase coded signal, which along with data control words from the Pulse Data Control section of the Pulse Control module are inputs to the Gain Control Amplifier section. This section acts as a multiplying analog-to-digital convertor to provide pulse droop compensation and an ungated, amplitude modulated Transmitter Drive Waveform (TDW) is outputted. This signal is buffered in the Amplifier section and output to the front panel TRANSMITTER DRIVE potentiometer via the W0678-19B/GR DROOP module (at single-rated stations, the signal is output directly to the front panel). The signal returns to the Amplifier section where it is again buffered, then enters the Gating Power Amplifier section. This section controls the start of the TDW by using the 500- μ sec Gate-H and Gate-L signals from the Tail Gate Generator section of the W0678-19B/GR DROOP module. The timing of the Gate-H and Gate-L signals is controlled by the Envelope Timing Adjust (ETA) switch on the timer or Remote Control Interface (RCI) by controlling the MPT timing. This section outputs a balanced Transmitter Drive Waveform to the transmitters via the Interface Unit, and signals to the Lost Signal Detector section (see Figures 5.34 and 5.35). A loss of the drive waveform generates a No Transmitter Drive signal to the TCC and will light the ALARM-NO TRANSMITTER DRIVE LED on the front panel of the PGEN. The Transmitter 1 & 2 Operate and Lamp Test signals are also inputs to the Lost Signal Detector section. These signals light the correct LED (ALARM or OPERATE).

4.3.3.2 W0678-19B/GR DROOP module (see Figure 7.34). The MPTs of both rates are inputs to the Droop Generator and Filter section. The programming (paragraph 2.6.2) and adjustments (paragraph 2.7.2) of the low pass filters generate the droop compensating waveforms in this section. Pulse droop compensation is produced by using the rate of interest MPTs. The other rate MPTs are used to produce a dynamic compensation waveform as the two rates move with respect to each other. The droop compensating waveforms are inputs to the Group Droop Summing Amplifier section. This section produces a 1-volt reference level and sums the compensating waveforms with the 1-volt reference level to produce a composite, compensation waveform (see paragraph 2.7.2). Inputs to the Tail Gate Generator section are Local Interval and the 80- μ sec Gate-L signal from the Control section of the W0678-2/PCON module. The 80- μ sec Gate-L signal is used to generate two 500- μ sec gates (Gate-H, Figure 5.36, and Gate-L) used by the Gating Power Amplifier section of the W0678-1/PSYN module. The 500- μ sec Gate-L signal and Local Interval are used to generate a tail gate signal for the Pulse Tail Generator section of this module. This section uses the tail gate signal to superimpose an exponentially decaying, tail

shaping waveform on the composite, compensation waveform from the Group Droop Summing Amplifier section. The decay time constant is varied by the adjustment of R25. This signal is used to modulate the ungated, amplitude modulated TDW in the Hundred Kilohertz Modulator section. This provides dynamic droop compensation and a controlled tail for the drive pulses. The 500- μ sec Gate-L signal and the Phase Code-H signal from the Phase Code Control section of the W0678-2/PCON module are used to produce a Reclocked Phase Code-H signal in the Phase Code Reclock section. This signal is an input to the Switched Inverting Amplifier section of the W0678-1/PSYN module. Also present on this module is the Deccajector Summing Amplifier section. This section is only wired for use on the W0686-20/GR DROOP module. The Deccajector Summing Amplifier section sums the deccajector outphasing signals with the 100 kHz used to produce the drive waveform. This prevents interference to DECCA navigation equipment by LORAN-C transmitters.

4.3.3.3 W0678-2/PCON module (see Figure 7.36). The Local Interval (see Figure 5.40), 100-kHz sine wave (see Figure 5.39), and MPT-H (see Figure 5.46) signals are inputs to the Control section of this module. These inputs are used to generate the Gate-L and Gate-H signals. At single-rated stations not employing tail drive, both signals are inputs to the W0678-1/PSYN module. At dual-rated stations, the 80- μ sec Gate-H signal is not used, and the 80- μ sec Gate-L signal is a W0678-19B/GR DROOP module input. The switch, S1, allows for the selection of half drive cycle or full drive cycle control with the PULSE SYNTHESIZER thumbwheel switches. A threshold detector is used to determine the zero crossing of the 100-kHz sine wave. This is used to generate a timing control waveform for the Cycle Selection section. This section uses the timing control waveform to select the front panel PULSE SYNTHESIZER switch digit to be read. The Pulse Selection section uses the timing control waveform to select the proper front panel DROOP switch digit. The Cycle Data Control section has inputs from the PULSE SYNTHESIZER thumbwheel switches and outputs data control words to the Multiplying Digital to Analog Converter section of the W0678-1/PSYN module. The Pulse Data Control section has inputs from the DROOP thumbwheel switches and outputs data control words to the Gain Control Amplifier section of the W0678-1/PSYN module. The Scope Trigger Generator section uses inputs from the Pulse Selection section, the Gate-L signal and the position of the front panel SCOPE TRIGGER switch (S1) to generate a scope trigger from the 1st or 2nd MPT. The Phase Code Control section uses Phase Code Set and Reset (see Figures 5.42 through 5.45) from the Loran Timing Set(s) and the inverted Local Interval from the Control section to generate the Phase Code-H signal for the Phase Code Reclock section of the W0678-19B/GR DROOP module (at stations with tail drive). At stations without tail drive, the Phase Code-H signal is generated for the Switched Inverting Amplifier section of the W0678-1/PSYN module.

4.3.4 Interface Unit (see Figure 7.38). The Interface Unit distributes signals to other units. This unit receives the Operate RF from the Current Transformer through a balanced, 100-ohm, double shielded cable. Two hybrid power splitters receive this signal. One splitter outputs two in-phase RF signals to the Loran Timing Set(s) (for the cycle compensation loop); the EPA and TCC receive an inverted RF signal from the other splitter. If either in-phase output is unused (single-rated operation), it must be terminated in 50 ohms.

4.4 Time-ladder Diagrams. Figures 4.1 and 4.2 are the time-ladder diagrams for master and secondary stations, respectively. The signals are received by the TCS equipment from the Loran Timing Set(s). The Local Interval starts 500 μ sec before the first MPT and ends 1,400 μ sec after the last MPT. The master station's Local Interval is 10,900 μ sec long, and the secondary station's Local Interval is 8,900 μ sec long. Phase Coding of the MPTs occur between the Phase Code Reset (starts the negative \emptyset code) and Phase Code Set (starts the positive \emptyset code) pulses.

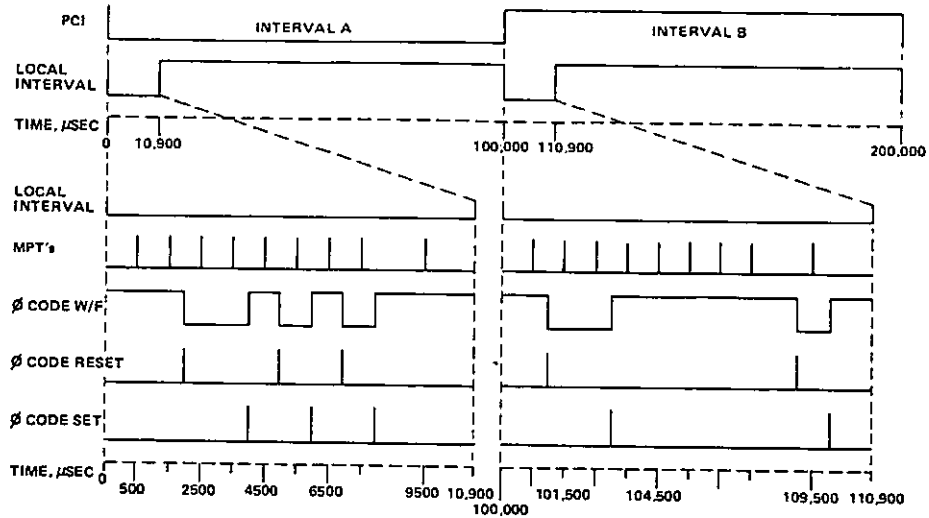


Figure 4.1. Master Station Time-Ladder Diagram
(Non-Existing Rate 10,000)

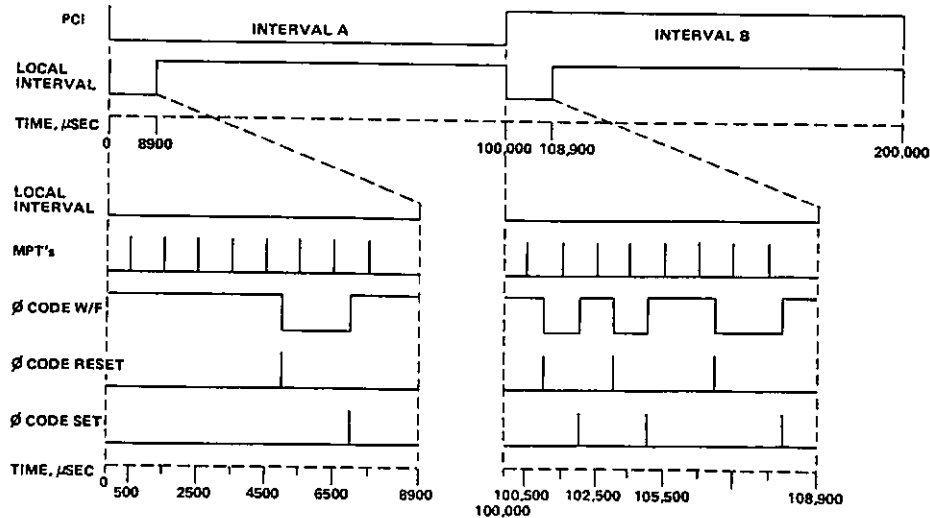


Figure 4.2. Secondary Station Time-Ladder Diagram
(Non-Existing Rate 10,000)

CHAPTER 5
MAINTENANCE

5.1 Maintenance Policy. The Inventory Control Point (ICP) designates the maintenance policy, which is found in E/GICPINST 4408.1 (series).

NOTE

Insure that proper care is taken while performing the following checks, measurements, or adjustments, as improper procedures may cause an OFF AIR condition.

5.2 Preventive Maintenance. If the following checks fail, refer to paragraph 5.3 for corrective maintenance.

5.2.1 Electrical Equipment Cabinet. Perform the following inspections quarterly:

a. Inspect the cabling and wiring for frayed, damaged, or broken wiring, and repair as necessary.

b. Inspect the power receptacle strip and power cords for damaged or exposed leads, and repair or replace as necessary.

c. Inspect the ground system to ensure that there are no breaks, and repair or replace as necessary.

d. Inspect the cabinet power cable to ensure that it is in good condition and not exposed.

5.2.2 Switch Assembly. Perform preventive maintenance procedures in accordance with local directives.

5.2.3 Transmitter Coupler Control. Periodically use the TCC to routinely switch transmitters.

5.2.4 Electrical Pulse Analyzer. In conjunction with the station inspection, adjust the W0678-11A/CLP ATTN module as outlined in paragraph 5.3.3.2.c.

5.2.5 Pulse Generator. Perform preventive maintenance procedures in accordance with local directives.

5.2.6 Waveform Panel. Perform preventive maintenance procedures in accordance with local directives.

5.2.7 Interface Unit. Perform preventive maintenance procedures in accordance with local directives.

5.3 Corrective Maintenance. There are no troubleshooting guides for the Switch Assembly, Waveform Panel, and Interface Unit. If problems occur with these units, replace the unit according to E/GICPINST 4408.1 (series).

5.3.1 Troubleshooting guide.

5.3.1.1 Transmitter Control Set. The troubleshooting guide for the Transmitter Control Set is shown in Figure 5.1.

5.3.1.2 Switch Assembly. There is no troubleshooting guide for the Switch Assembly.

5.3.1.3 Transmitter Coupler Control. The troubleshooting charts for the TCC are shown in Figures 5.2 and 5.3.

5.3.1.4 Electrical Pulse Analyzer. The troubleshooting charts for the EPA are shown in Figures 5.4 through 5.9.

5.3.1.5 Pulse Generator. The troubleshooting charts for the PGEN are shown in Figures 5.10 and 5.11.

5.3.1.6 Waveform Panel. There is no troubleshooting guide for the Waveform Panel.

5.3.1.7 Interface Unit. There is no troubleshooting guide for the I/F Unit.

THERE IS A PROBLEM IN
THE AN/FN-60 EQUIPMENT



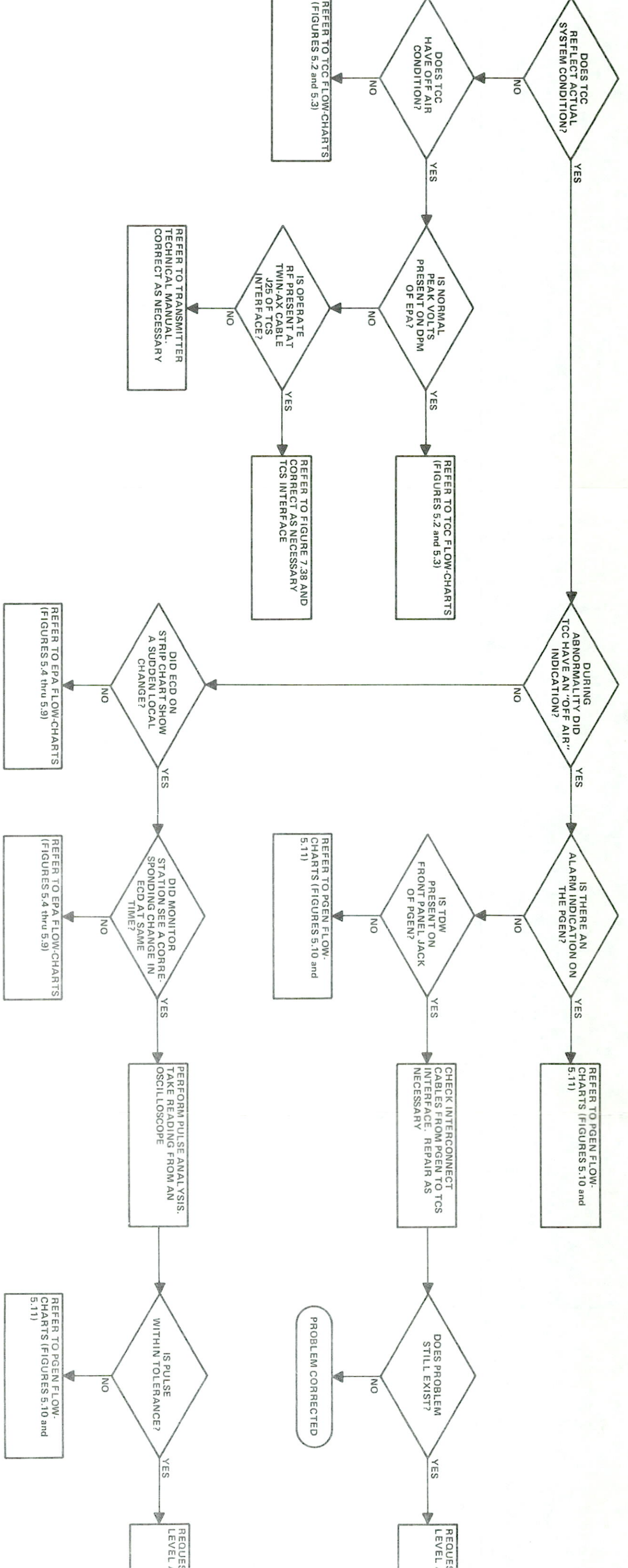


Figure 5.1. Transmitter Troubleshooting

ST INTERMEDIATE
ASSISTANCE

ST INTERMEDIATE
ASSISTANCE

Control Set (TCS)
ting Flow-Chart

5.3/5.4

THERE IS A PROBLEM IN THE TCC

PUT THE TRANSMITTER INTO LOCAL CONTROL

PUT THE TRANSMITTER INTO LOCAL CONTROL

CHECK 2 OF PS2

NOTES:

1. IF REPLACEMENT OF THE MODULE DOES NOT CORRECT THE PROBLEM, RE-INSERT THE ORIGINAL MODULE.
2. RETURN ALL DEFECTIVE MODULES IAW E/GICP INSTRUCTIONS.
3. THE TABLE ON THIS PAGE SHOWS THE LIMITS ALLOWABLE ON THE POWER SUPPLIES. REFER TO FIGURE 5.12 FOR THE POWER SUPPLY TEST POINT AND ADJUSTMENT LOCATIONS. REFER TO PARAGRAPH 5.3.3.1 FOR THE ADJUSTMENT PROCEDURES. IF THE POWER SUPPLY CANNOT BE ADJUSTED TO WITHIN LIMITS, REPLACE IT AND ADJUST THE NEW ONE.
4. HAVE ONE TECH IN THE XMTR BLDG IN CONSTANT CONTACT WITH THE TIMER ROOM. HAVE THE TECH IN THE TIMER ROOM OBSERVE THE TCC LIGHT INDICATIONS. THE XMTR BLDG TECH SHOULD OBSERVE THE RF FEEDBACK ON AN OSCILLOSCOPE FOR INSTANT CONFIRMATION OF OFF AIR. IF THERE IS AN OFF AIR WHEN IN REMOTE CONTROL, SWITCH TO LOCAL CONTROL WITHIN 30 SECONDS, SO THE TCC WILL NOT ATTEMPT TO SWITCH XMTRS.

ANALYZE

115 V

CHECK FOR REPLACEMENT

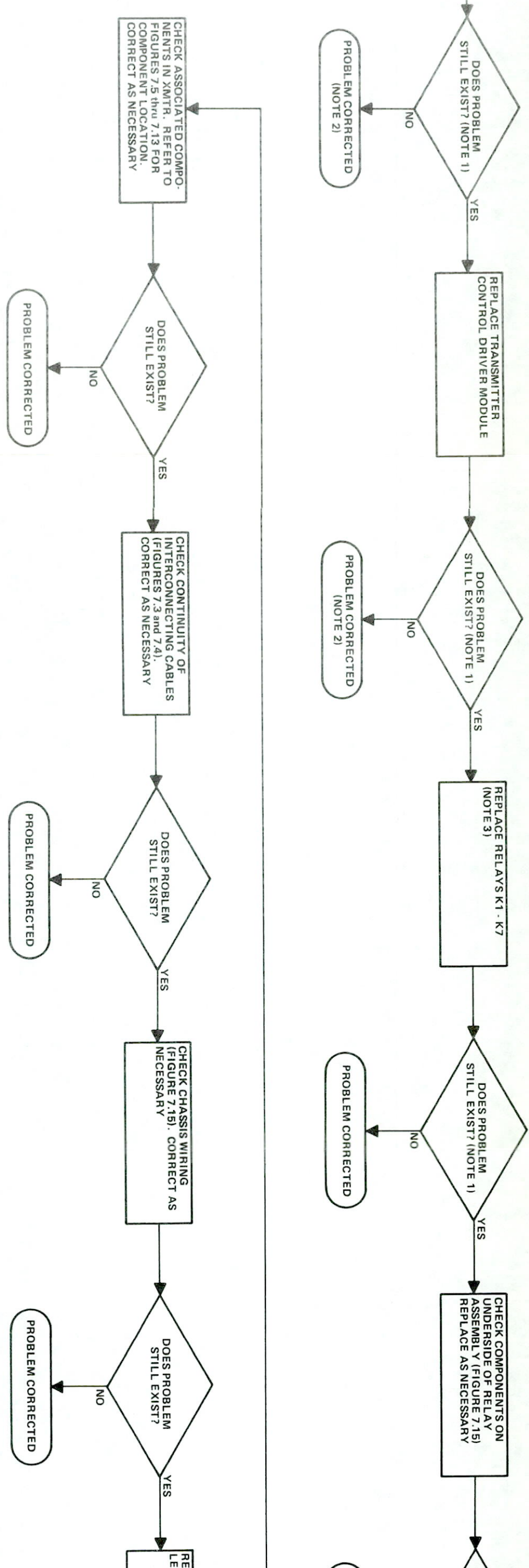
DIAGNOSTIC

PROBLEM

DW. LIMIT	AC RIPPLE LIMIT
+4.75V	1.4 mV
-14.5V	2.8 mV
+14.5V	2.8 mV
+22.5V	4.2 mV

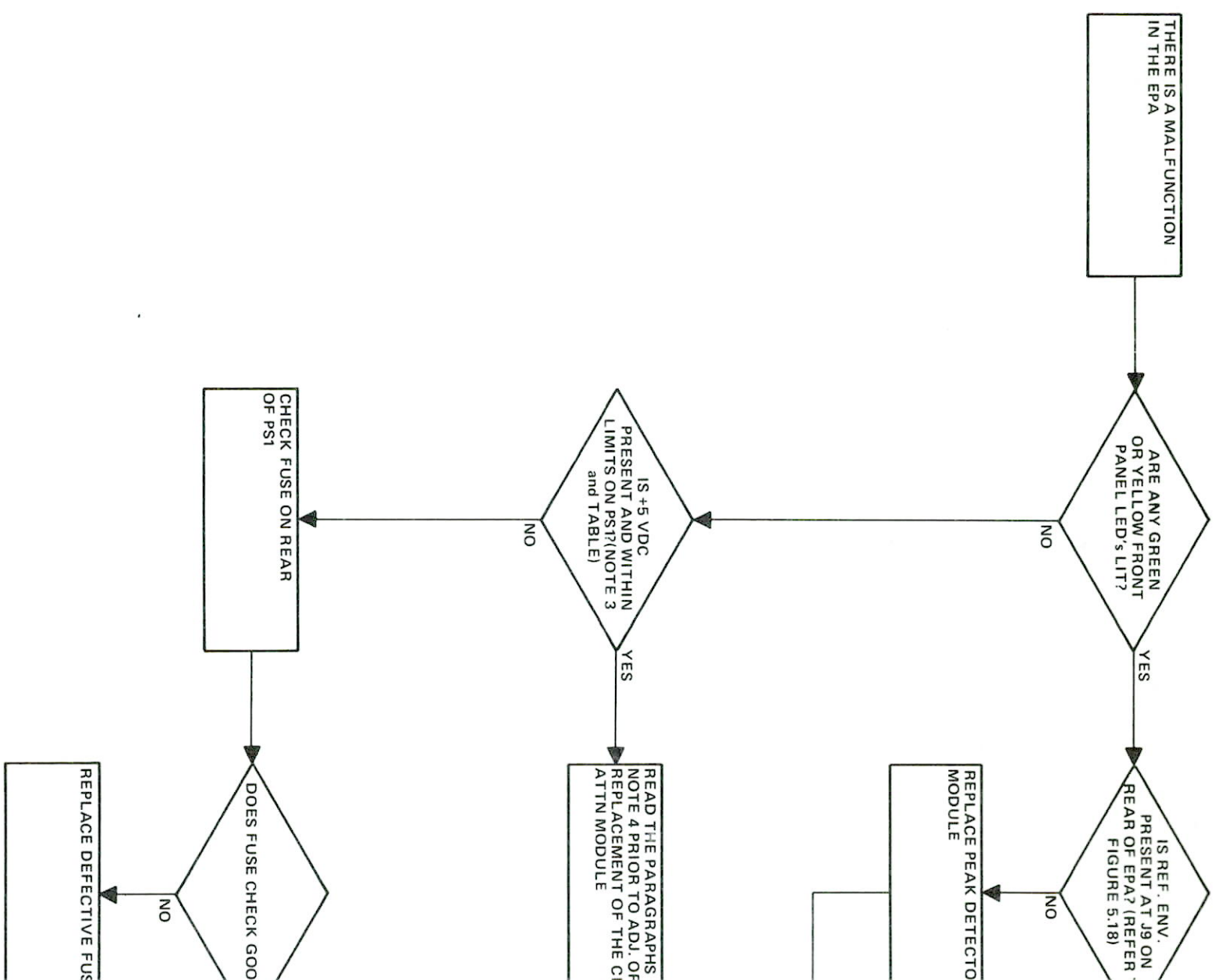
Control (TCC)
Chart (Sheet 1 of 2)

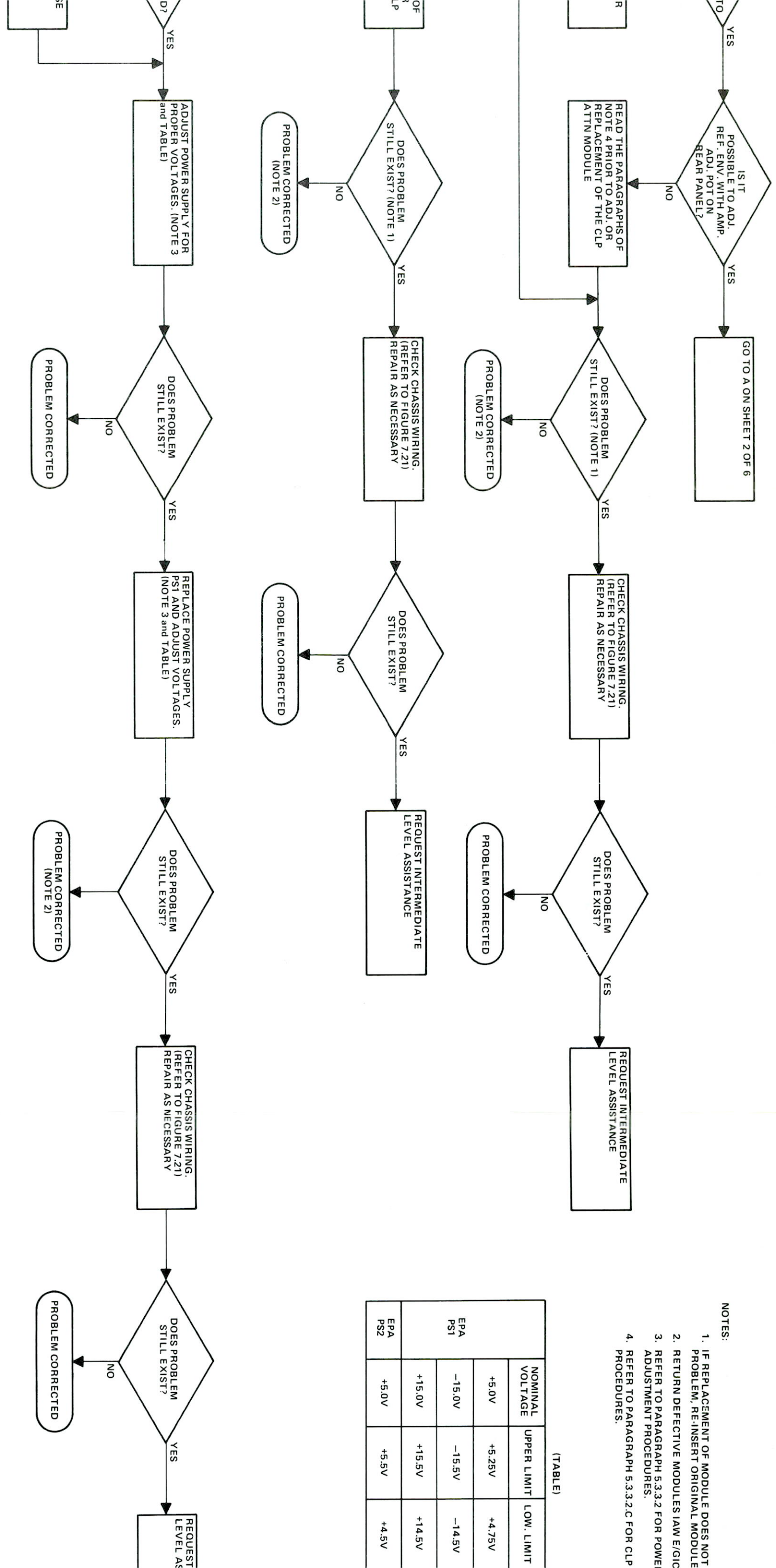




- NOTES:
1. IF REPLACEMENT OF MODULE DOES NOT CORRECT PROBLEM, INSERT ORIGINAL MODULE.
 2. RETURN DEFECTIVE MODULES IAW E/GICP INSTRUCTION
 3. REPLACE RELAYS IN THREE STEPS:
 - (1) K3, K4, K6 and K7
 - (2) K1 and K5
 - (3) K2
- CHECK FOR PROBLEM AFTER EACH STEP. IF PROBLEM IS CORRECTED CONTINUE TO NEXT DECISION BLOCK.

Figure 5.3. Transmitter Coupler Troubleshooting Flow-C





- NOTES:
1. IF REPLACEMENT OF MODULE DOES NOT SOLVE PROBLEM, REINSERT ORIGINAL MODULE
 2. RETURN DEFECTIVE MODULES IAW E/GIC
 3. REFER TO PARAGRAPH 5.3.3.2 FOR POWER SUPPLY ADJUSTMENT PROCEDURES.
 4. REFER TO PARAGRAPH 5.3.3.2.C FOR CLP ADJUSTMENT PROCEDURES.

(TABLE)

	NOMINAL VOLTAGE	UPPER LIMIT	LOW. LIMIT
EPA PS1	+5.0V	+5.25V	+4.75V
	-15.0V	-15.5V	-14.5V
EPA PS2	+15.0V	+15.5V	+14.5V
	+5.0V	+5.5V	+4.5V

Figure 5.4. Electrical Pulse Analyzer Troubleshooting Flow-

CORRECT

OPERATING INSTRUCTIONS.

POWER SUPPLY

ATTENTION ADJUSTMENT

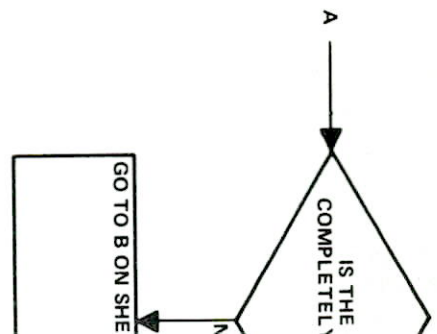
AC RIPPLE LIMIT
1.4 mV
2.8 mV
2.8 mV
15 mV

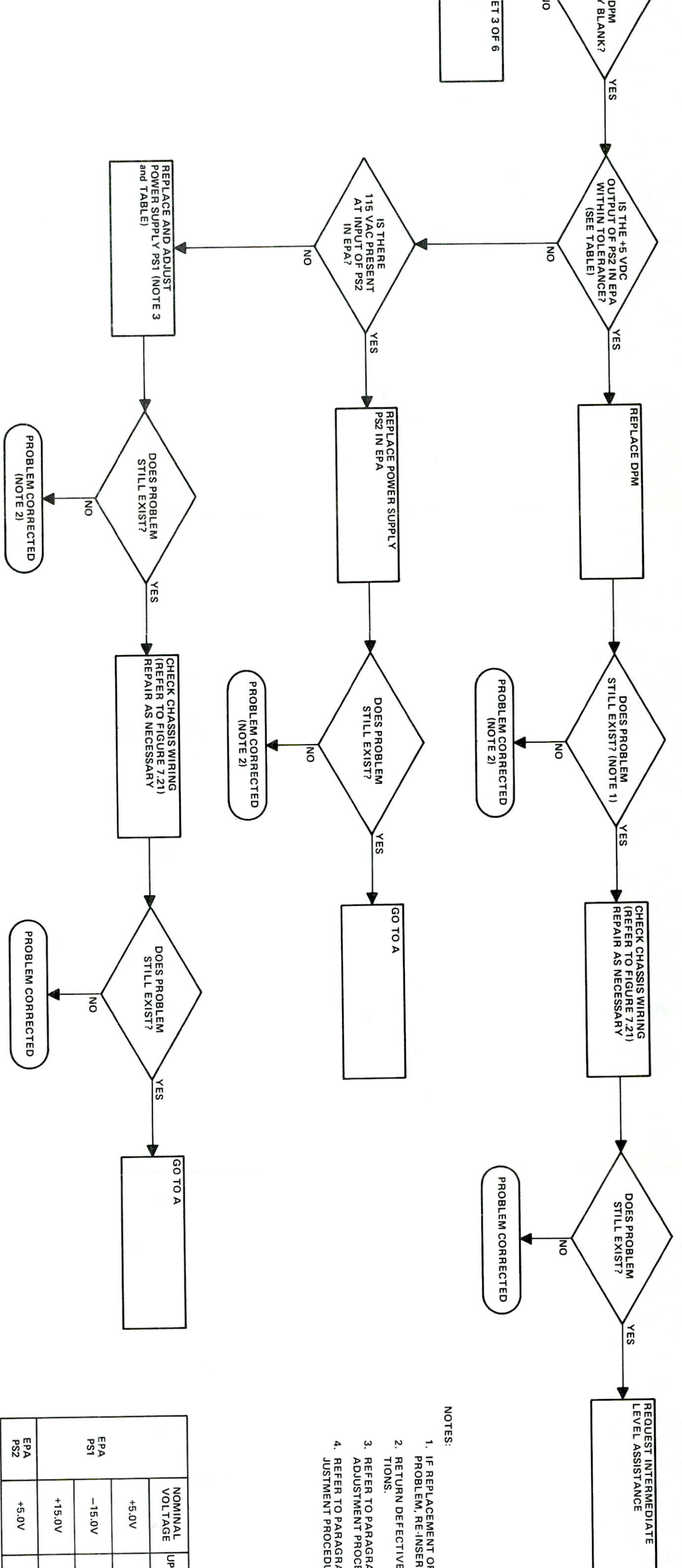
INTERMEDIATE
ASSISTANCE

Operator (EPA)

Chart (Sheet 1 of 6)

5.9/5.10





- NOTES:
1. IF REPLACEMENT OF MODULE DOES PROBLEM, REINSERT ORIGINAL MODULES.
 2. RETURN DEFECTIVE MODULES TO MANUFACTURER.
 3. REFER TO PARAGRAPH 5.3.3.2 FOR ADJUSTMENT PROCEDURES.
 4. REFER TO PARAGRAPH 5.3.3.2 FOR JUSTMENT PROCEDURES.

(TABLE)

EPA PS1	NOMINAL VOLTAGE		UPPER LIMIT	LOWER LIMIT
	+	-		
EPA PS1	+5.0V	-15.0V	+5.25V	-15.5V
	+15.0V	-15.5V	+15.5V	-16.0V
EPA PS2	+5.0V	-	+5.5V	-

Figure 5.5. Electrical Pulse Analyzer Troubleshooting Flow-C

STATUS NOT CORRECT

MODULE.

SEE/GICP INSTRUC.

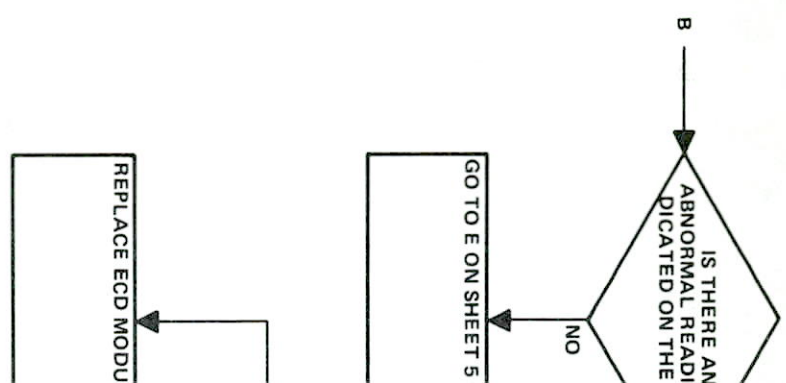
POWER SUPPLY

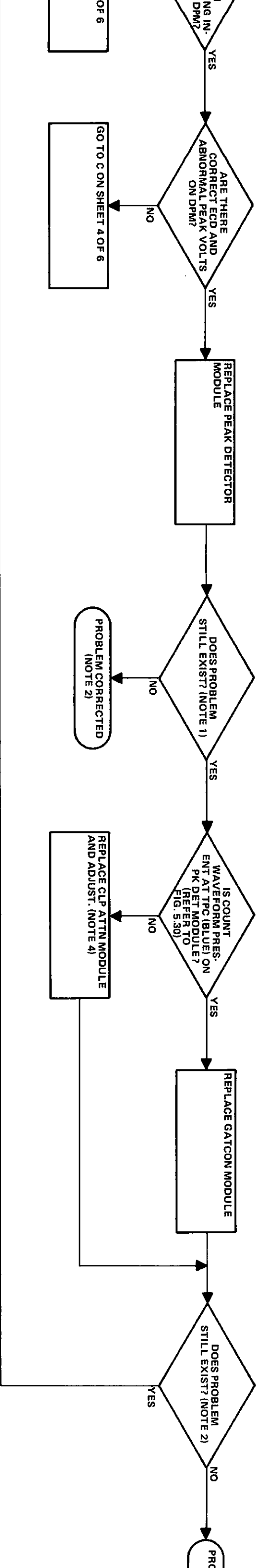
CLP ATTN AD.

N. LIMIT	AC RIPPLE LIMIT
4.75V	1.4 mV
-14.5V	2.8 mV
14.5V	2.8 mV
+4.5V	15 mV

FORM (EPA)
Chart (Sheet 2 of 6)

5.11/5.12





- NOTES:
1. IF REPLACEMENT OF MODULE DOES NOT CORRECT PROBLEM, RE-INSERT ORIGINAL MODULE.
 2. RETURN DEFECTIVE IAW E/GICP INSTRUCTIONS.
 3. REFER TO PARAGRAPH 5.3.3.2 FOR POWER SUPPLY ADJUSTMENT PROCEDURES.
 4. REFER TO PARAGRAPH 5.3.3.2 FOR CLP ATTN ADJUSTMENT PROCEDURES.

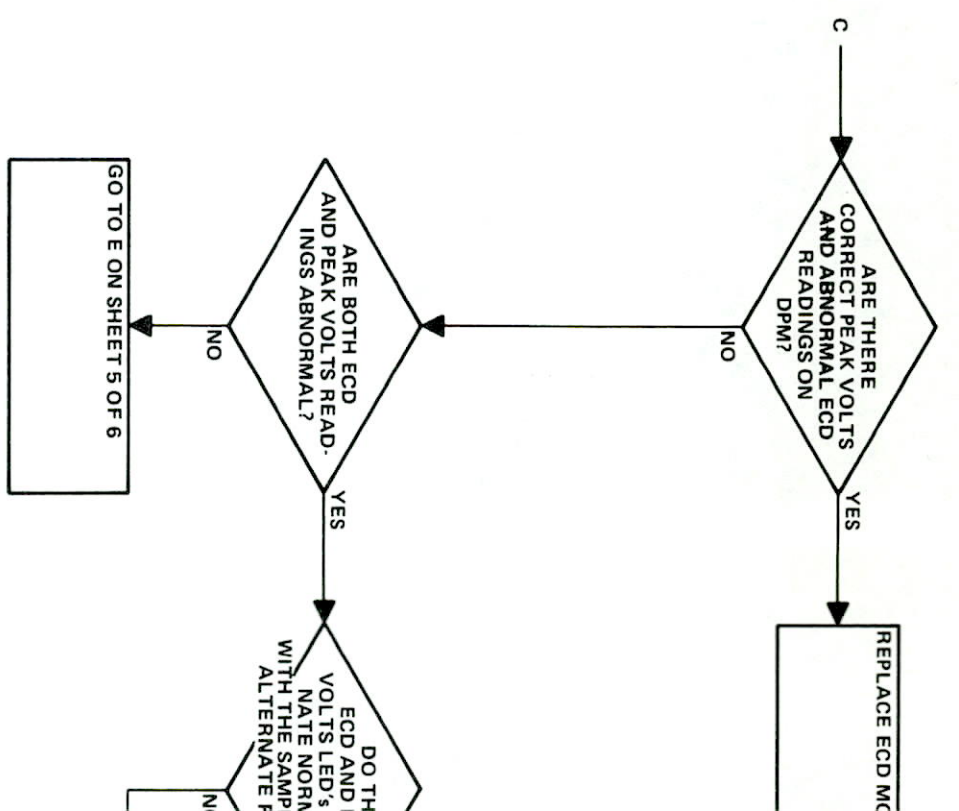
	NOMINAL VOLTAGE	UPPER LIMIT	LOW. LIMIT	AC RIPPLE LIMIT
EPA PS1	+5.0V	+5.25V	+4.75V	1.4 mV
	-15.0V	-15.5V	-14.5V	2.8 mV
EPA PS2	+15.0V	+15.5V	+14.5V	2.8 mV
	+5.0V	+5.5V	+4.5V	15 mV

Figure 5.6. Electrical Pulse Analyzer (EPA) Troubleshooting Flow-Chart

PROBLEM CORRECTED
(NOTE 2)

PA)
t (Sheet 3 of 6)

5.13/5.14



- NOTES:
1. IF REPLACE RE-INSERT
 2. RETURN DE
 3. REFER TOP PROCEDURE
 4. REFER TOP PROCEDURE

EPA PS1		NOM VOL
	+5	
	-11	
	+19	

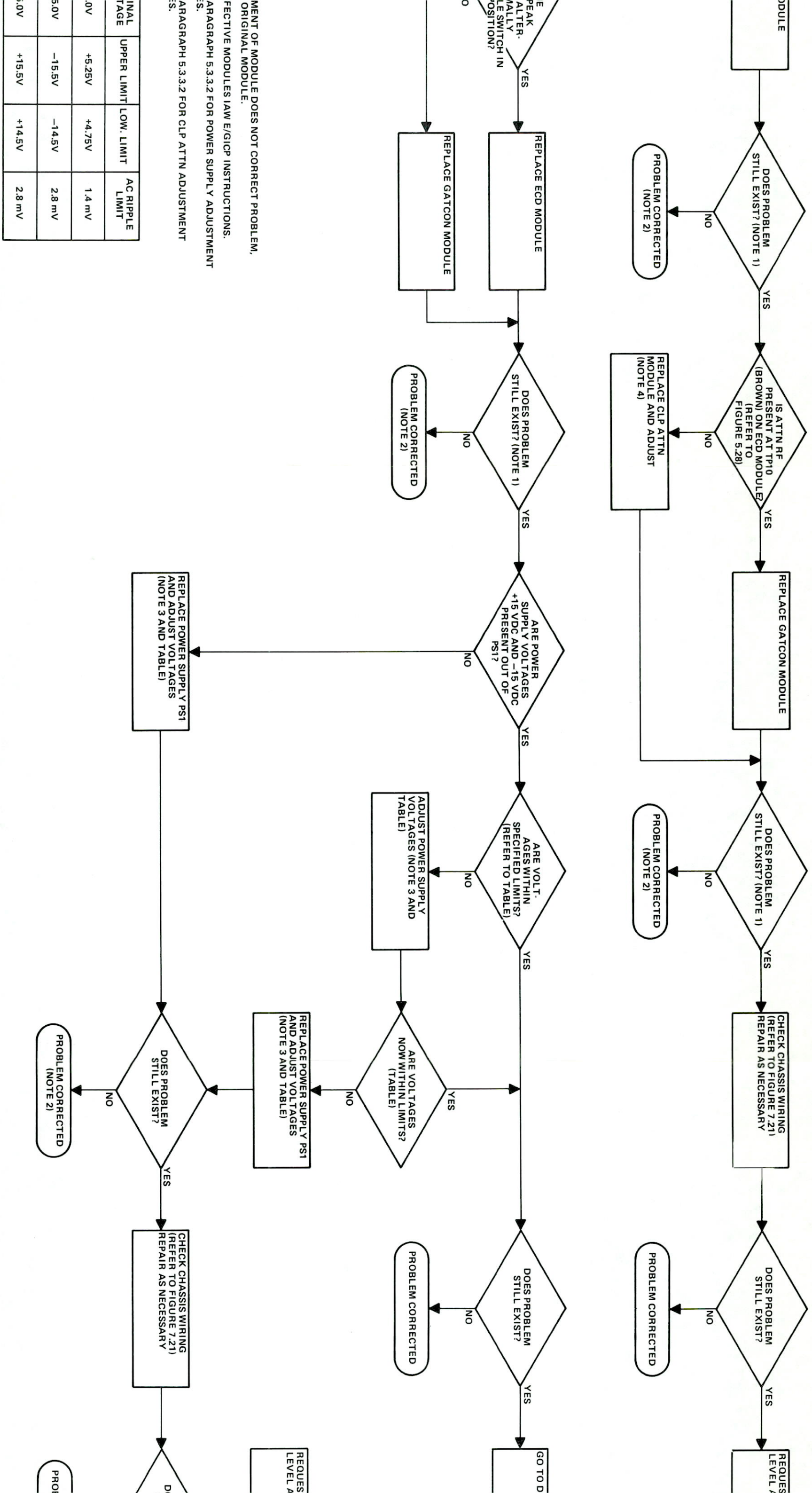


Figure 5.7. Electrical Pulse Analyzer (Troubleshooting Flow-Ch

AT INTERMEDIATE
ASSISTANCE

ON SHEET 5 OF 6

AT INTERMEDIATE
ASSISTANCE

YES

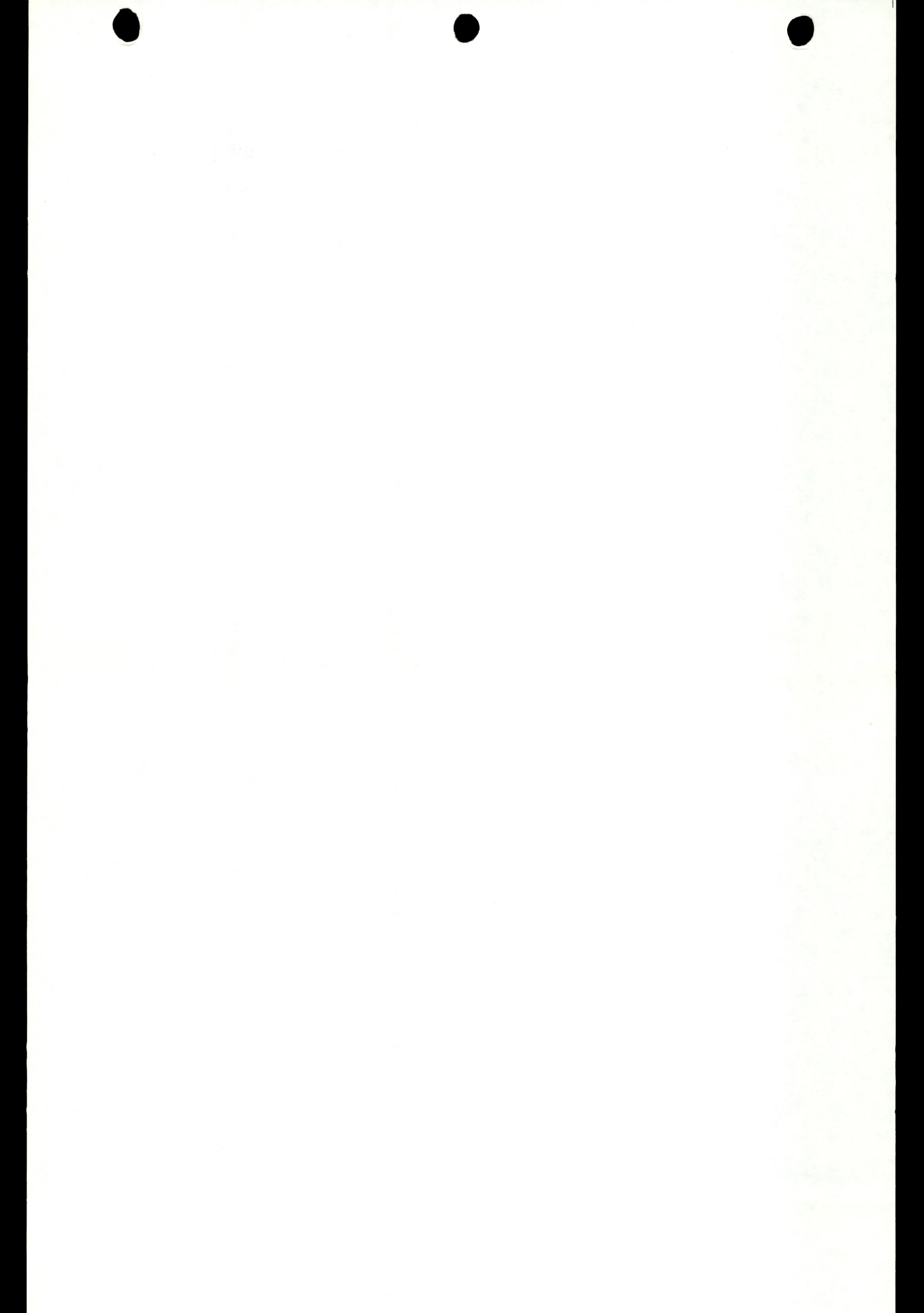
DOES PROBLEM
STILL EXIST?

BLEM CORRECTED

EPA)

art (Sheet 4 of 6)

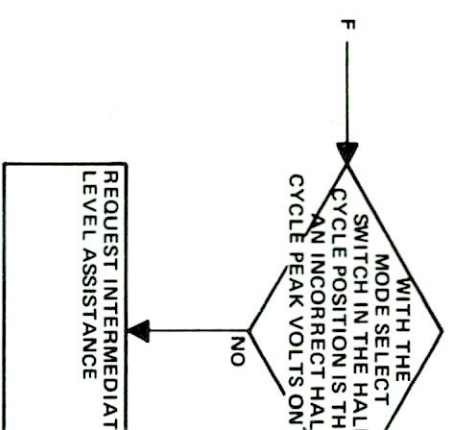
5.15/5.16

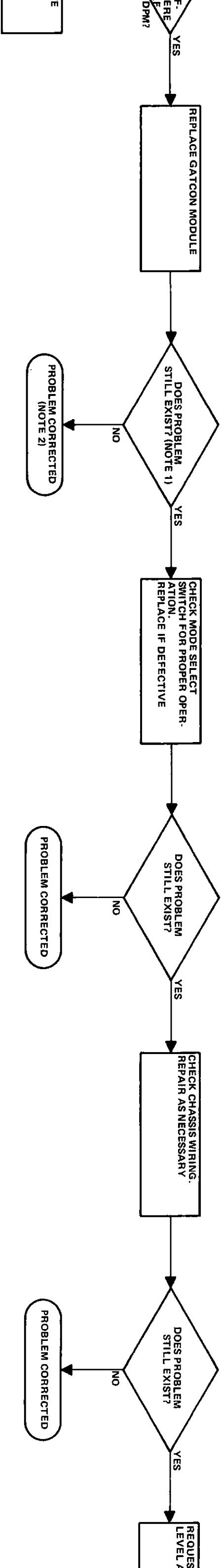


PROBLEM CORRECTED

Analyzer (EPA)
Flow-Chart (Sheet 5 of 6)

5.17/5.18





NOTES:

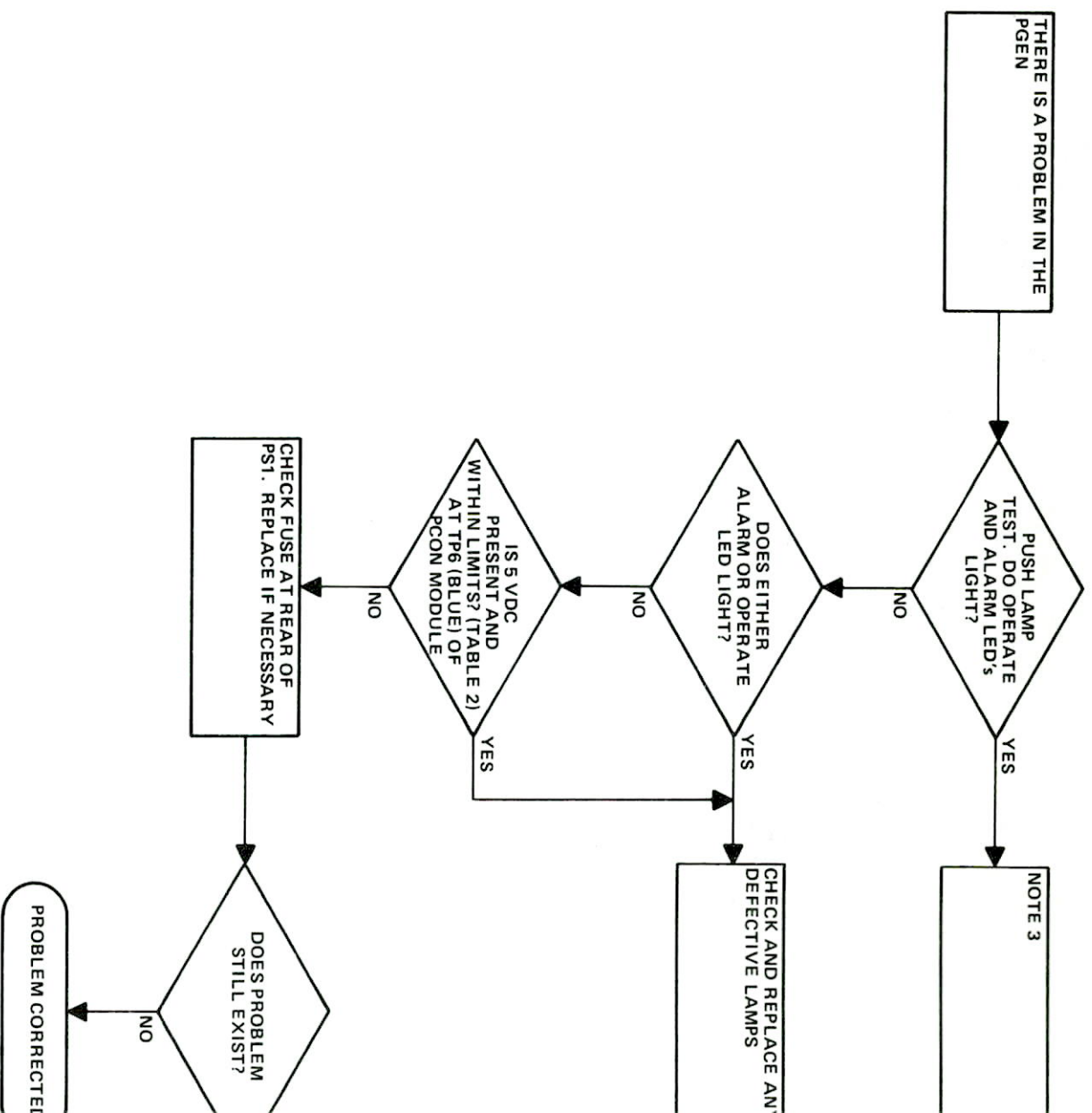
1. IF REPLACEMENT OF MODULE DOES NOT CORRECT PROBLEM, REINSERT ORIGINAL MODULE.
2. RETURN DEFECTIVE MODULES IAW E/GICP INSTRUCTIONS.

Figure 5.9. Electrical Pulse Analyzer (EPA) Troubleshooting Flow-Chart

INTERMEDIATE
ASSISTANCE

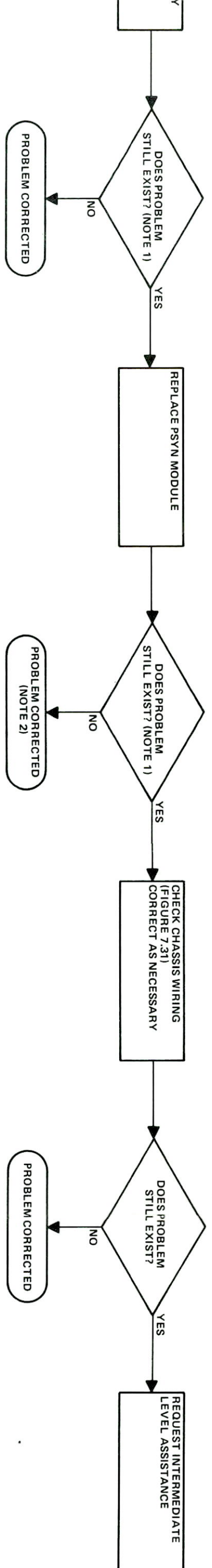
EPA)
rt (Sheet 6 of 6)

5.19/5.20



(TABLE)

	A	B	C
(1)	1	2	3
(2)	5	6	3
(3)	5	6	3
(4)	5	6	3



NOTES:

1. IF REPLACEMENT OR MODULE DOES NOT CORRECT RE-INSERT ORIGINAL MODULE.
 2. RETURN DEFECTIVE MODULE IAW E/GICP INSTRUCTIONS.
 3. FIND STATION TYPE IN (1) THROUGH (4) BELOW. USE CROSS REFERENCE STATION TYPE WITH PROBLEM WITH NUMBER FROM TABLE 1 CONTINUE FLOW-CHART IF MORE THAN ONE PROBLEM EXISTS, SOLVE ONE TIME.
- STATIONS:
- (1) SINGLE-RATED, 39/42 OR 44/45 TRANSMITTER WITH FEEDBACK MOD.
 - (2) DUAL-RATED, 39/42 OR 44/45 TRANSMITTER WITH FEEDBACK OR TAIL DRIVE MOD.
 - (3) 44/45 TRANSMITTER WITH TAIL DRIVE DUAL-RATED)
 - (4) 44/45 TRANSMITTER WITH FEEDBACK DUAL-RATED)
4. CHECK VOLTAGES ON POWER SUPPLY AND ADJUST FOR VOLTAGE AND RIPPLE, REFER TO TABLE 2. PARAGRAPH 5.3.3.3 FOR THE ADJUSTMENT PROCEDURE. SUPPLY CANNOT BE ADJUSTED TO WITHIN LIMITS. SUPPLY AND PERFORM THE ADJUSTMENTS.

	D	E	F
A. NO TDW			
B. NO PHASE CODE	N/A	3	7
C. NO HALF-CYCLE CONTROL FROM THUMBWHEEL SWITCHES (ONLY STATIONS USING HALF-CYCLE CONTROL)	4	3	7
D. NO DUAL-RATE COMPENSATION	4	3	7
E. NO PULSE DROOP COMPENSATION FROM THUMBWHEEL SWITCHES			
F. NO PHASE CODE BALANCE CONTROL	N/A	N/A	7

(TABLE 2)

	NOMINAL VOLTAGE	UPP. LIMIT	LOW. LIMIT	AC RIPPLE LIMIT
PGEN PSI	+5.0V	+5.25V	+4.75V	1.4 mV
	-15.0V	-15.5V	-14.5V	2.8 mV
	+15.0V	+15.5V	+14.5V	2.8 mV

Figure 5.10 Pulse Generator (PGEN) Troubleshooting Flow-C

T PROBLEM,

CTIONS.

SING TABLE 1,
IN PGEN.
PART ON SHEET 2.
PROBLEM AT A

MITTER WITHOUT

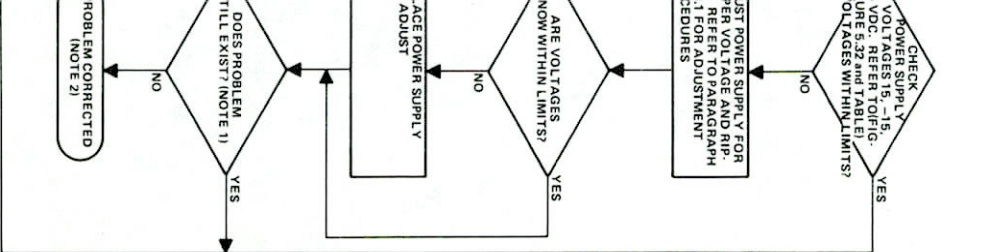
MOD. (SINGLE OR

T TO WITHIN LIMITS
REFER TO FIGURE
NS. REFER TO
DURES. IF THE POWER
REPLACE THE POWER

Chart (Sheet 1 of 2)

5.21/5.22





5.3.2 Test point data.

5.3.2.1 Transmitter Coupler Control. Figures 5.12 and 5.13a show the location of the voltage test and adjustment points of the power supplies in the TCC. Figure 5.13 shows the locations of the test points of the modules of the TCC. Figure 5.13 also shows the location of a potentiometer (R8) of the Transmitter Control Module. The test point waveforms are TTL level waveforms.

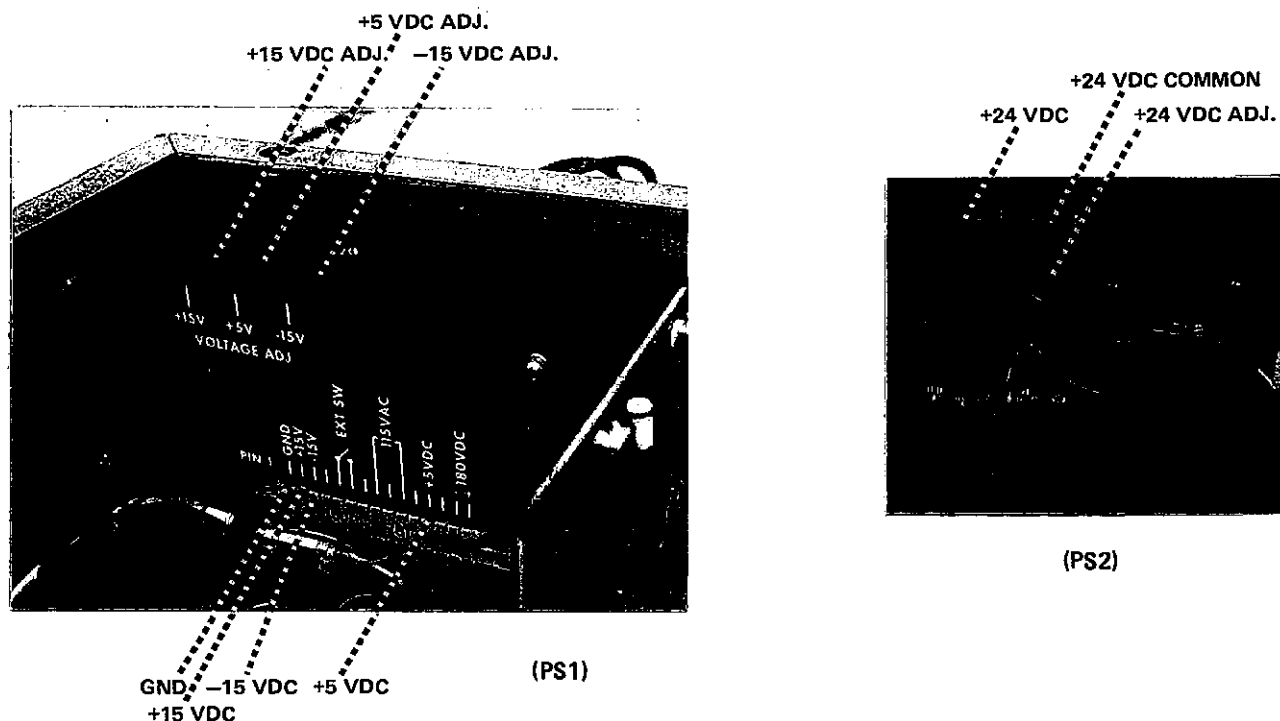


Figure 5.12. Voltage Test Point and Adjustment Locations of the TCC Power Supplies

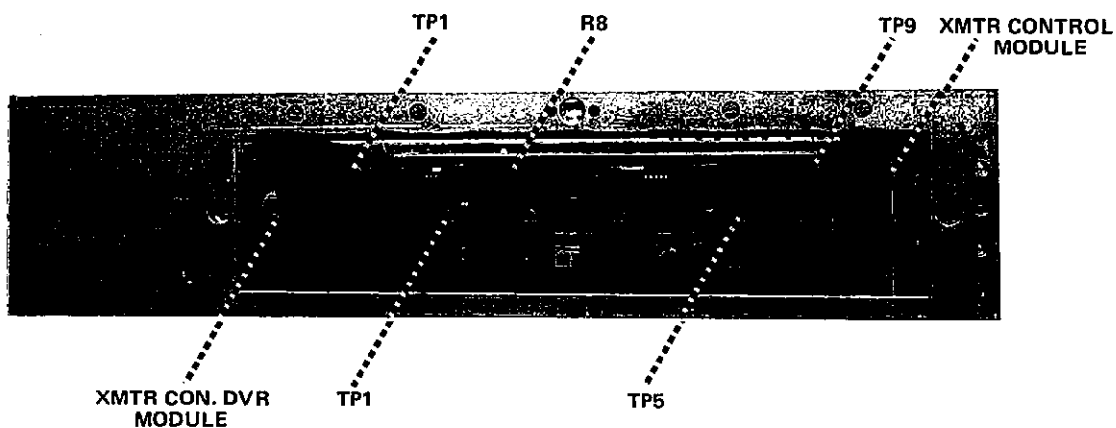


Figure 5.13. Test Point and Potentiometer Locations of the TCC Modules

CONTROL, COUPLER-TRANSMITTER

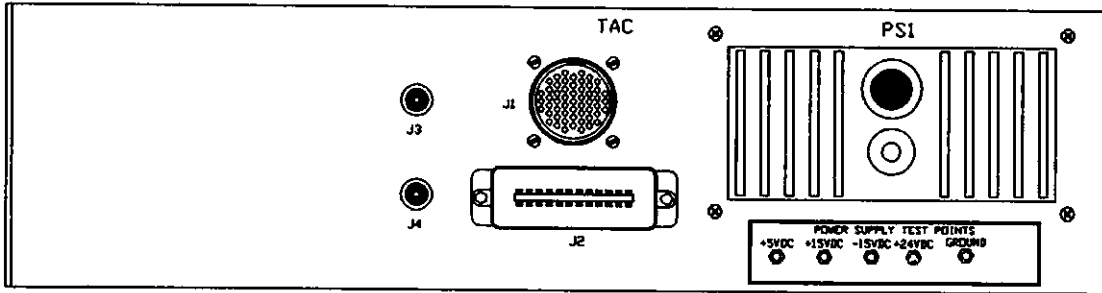


TABLE 1

TCC POWER SUPPLY WIRE HOOK-UP CONNECTION POINT(S) FOR TEST JACKS			
POWER SUPPLY AND VOLTAGES	CONNECTOR (XPS1)	TEST JACK DESTINATION	
PS1	+5VDC	PIN 12	TP1 RED
	+15VDC	PIN 2	TP2 BROWN
	-15VDC	PIN 3	TP3 BLUE
	GROUND	PIN 1	TP5 GREEN
PS2	+24VDC	SEE NOTE 1	TP4 ORANGE

NOTE 1

The PS2 +24VDC wire is connected directly to the orange test point.

TABLE 2

	NOMINAL VOLTAGE	UPPER LIMIT	LOWER LIMIT	AC RMS RIPPLE
PS1	+5.0V	+5.25V	+4.75V	1.4mV
	+15.0V	+15.0V	+14.5V	2.8mV
	-15.0V	-15.5V	-14.5V	2.8mV
PS2	+24.0V	+24.5V	+23.5V	4.2mV

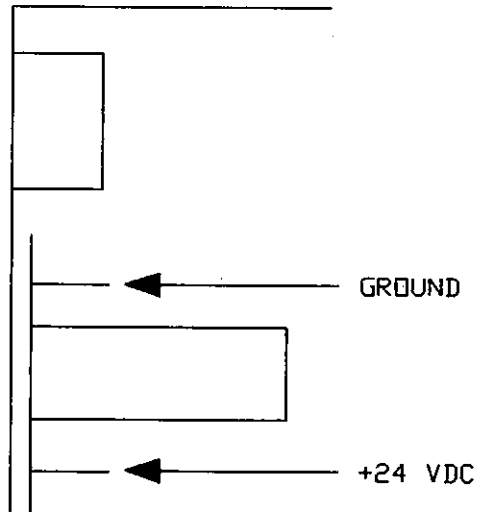


Figure 5.13a Power Supply Voltage Test Points of the Transmitter Coupler Control

5.3.2.2 Electrical Pulse Analyzer. Figures 5.14 and 5.15a show the locations of the voltage test and adjustment points of the (PS1) power supply of the EPA. They also show the location of the test points and R10 of the Clip Attenuator module. Figure 5.15 shows the test point locations of the Peak Detector, Gate Control, and ECD modules. Figures 5.16 to 5.31 show the waveforms of various jacks and test points of the EPA.

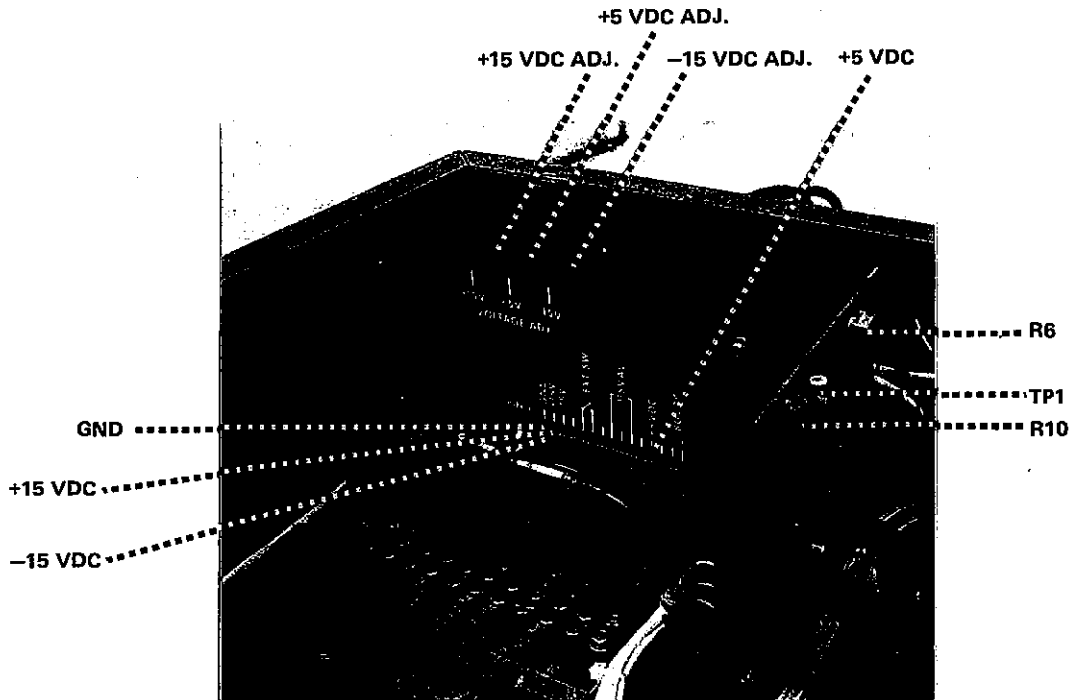


Figure 5.14. PS1 and CLP ATTN Test Point and Adjustment Locations

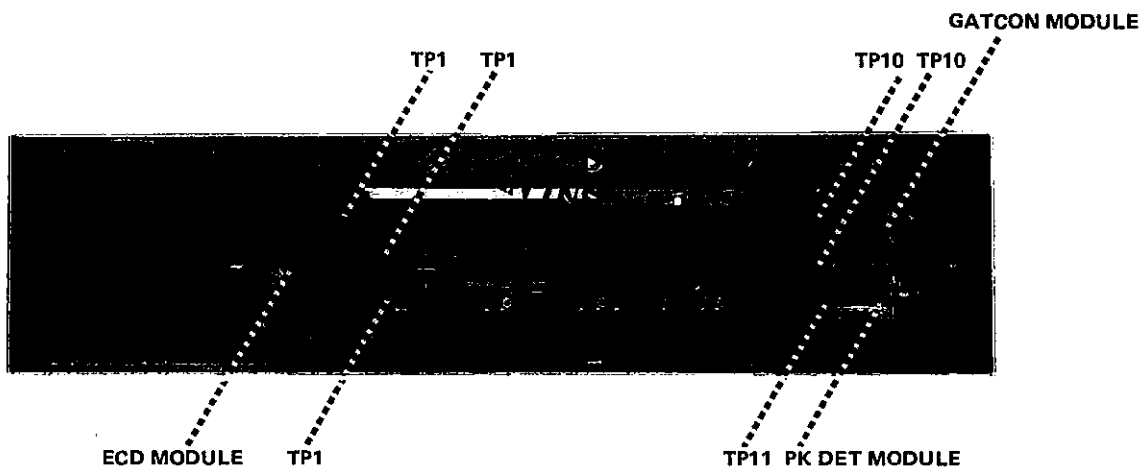


Figure 5.15. PK DET, GATCON, and ECD Test Point Locations

ELECTRICAL PULSE ANALYZER

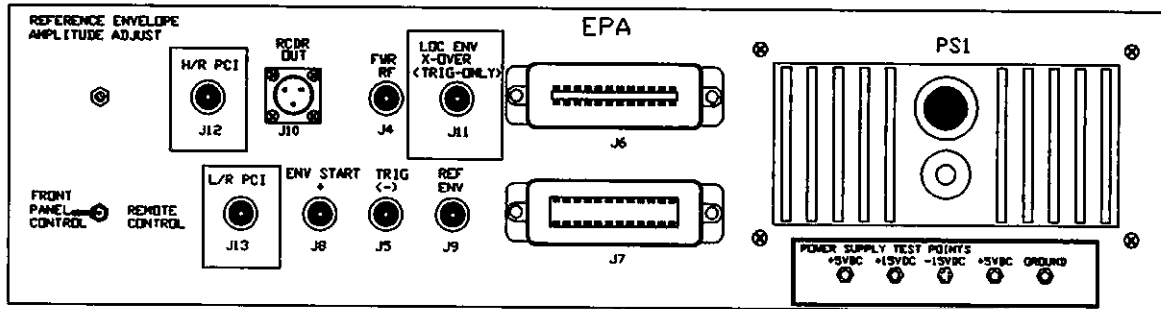


TABLE 1

EPA POWER SUPPLY CONNECTION POINT(S) FOR TEST JACKS			
POWER SUPPLY AND VOLTAGES	TP-1	TEST JACK DESTINATION	
PS1	+5VDC	PIN 2	TP1 RED
	+15VDC	PIN 6	TP2 BROWN
	-15VDC	PIN 4	TP3 BLUE
	GROUND	PIN 1	TP5 GREEN
GROUND			
PS2	+5VDC	SEE NOTE #1	TP4 ORANGE

NOTE 1

THE PS2 +5VDC WIRE IS CONNECTED DIRECTLY TO THE TP4 ORANGE TEST POINT

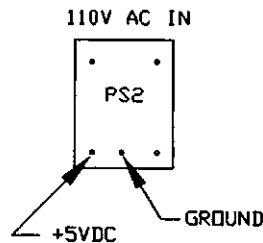


TABLE 2

	NOMINAL VOLTAGE	UPPER LIMIT	LOWER LIMIT	AC RMS RIPPLE
PS1	+5.0V	+5.25V	+4.75V	1.4mV
	+15.0V	+15.5V	+14.5V	2.8mV
	-15.0V	-15.5V	-14.5V	2.8mV
PS2	+5.0V	+5.50V	+4.50V	15mV

Figure 5.15a Power Supply Voltage Test Points of the Electrical Pulse Analyzer

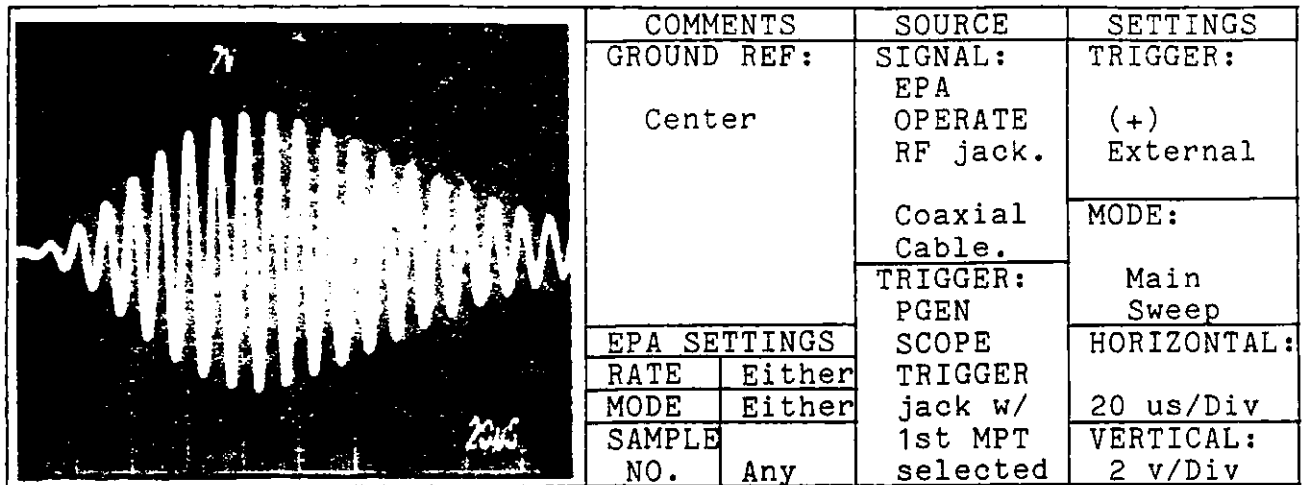


Figure 5.16. Operate RF Waveform

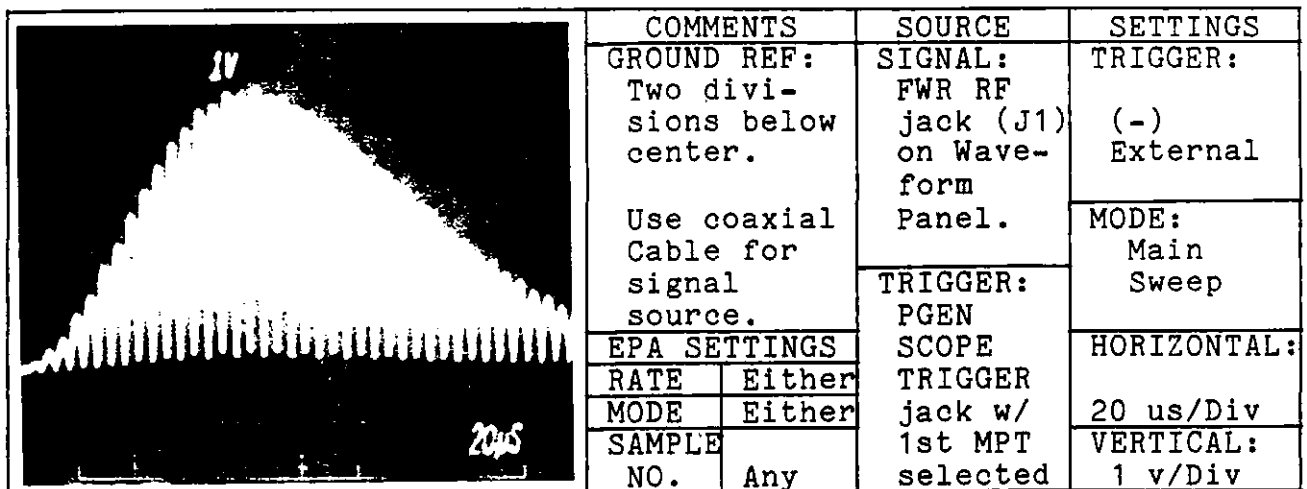
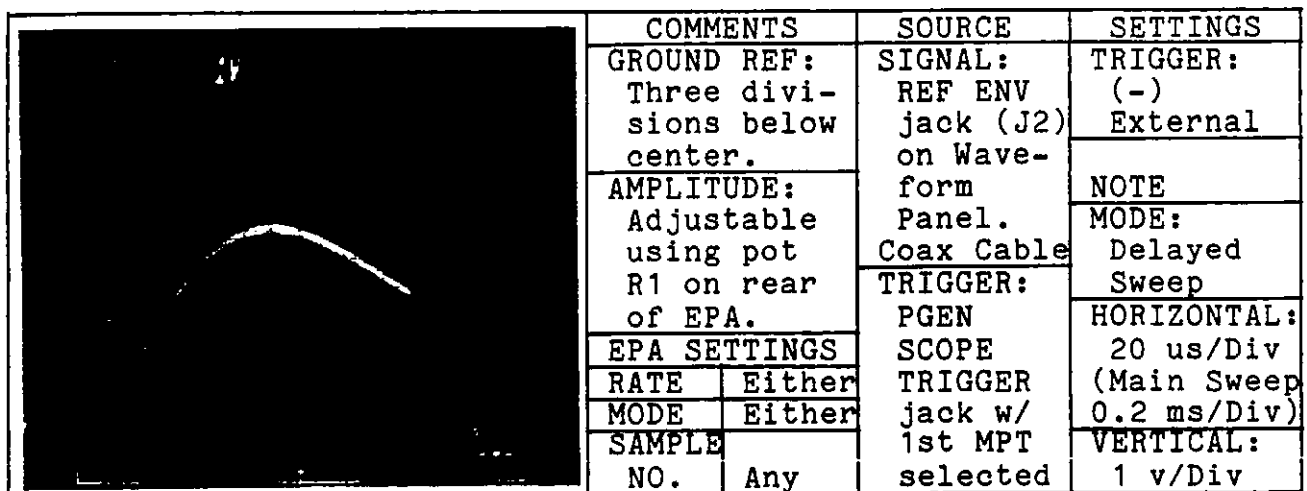


Figure 5.17. Full Wave Rectified RF Waveform



Note: Connect WP J3 to the oscilloscope delayed gate output. If no waveform is present, move the connection to WP J4.

Figure 5.18. Reference Envelope Waveform

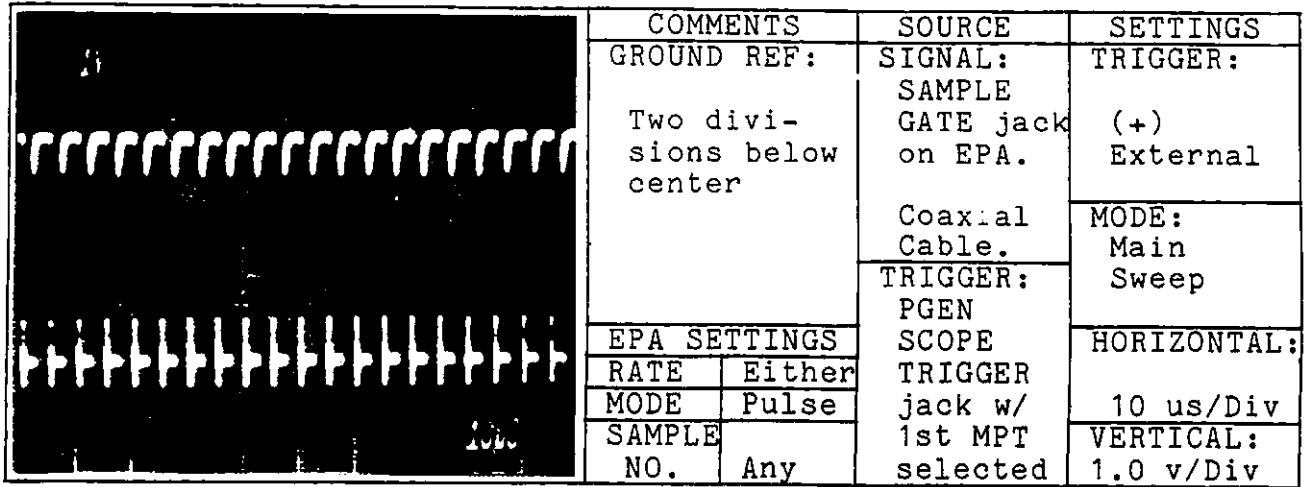


Figure 5.19. Sample Gate Waveform

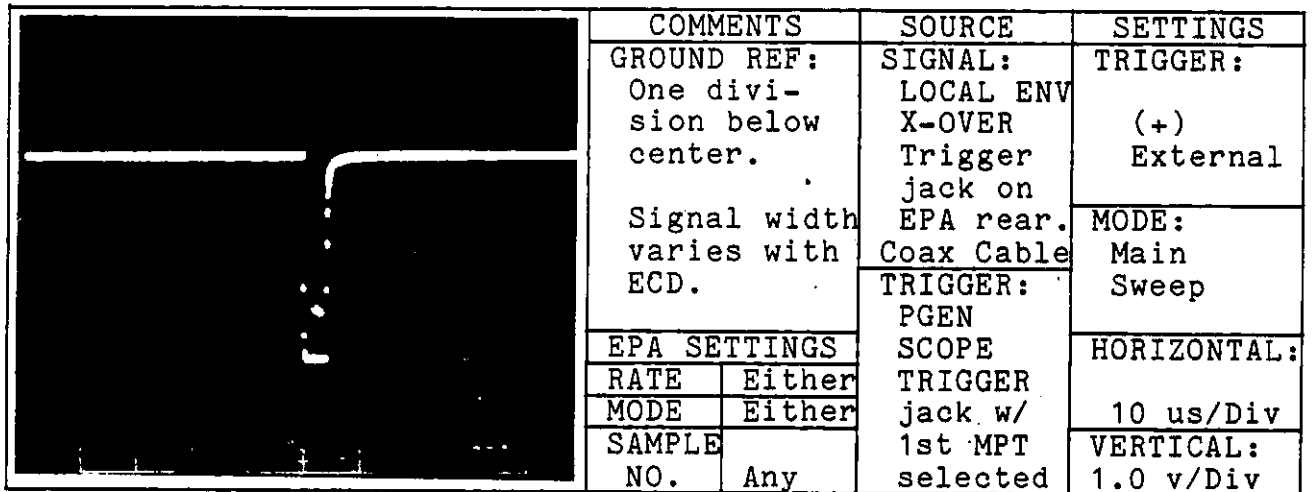


Figure 5.20. Local Envelope Crossover Trigger

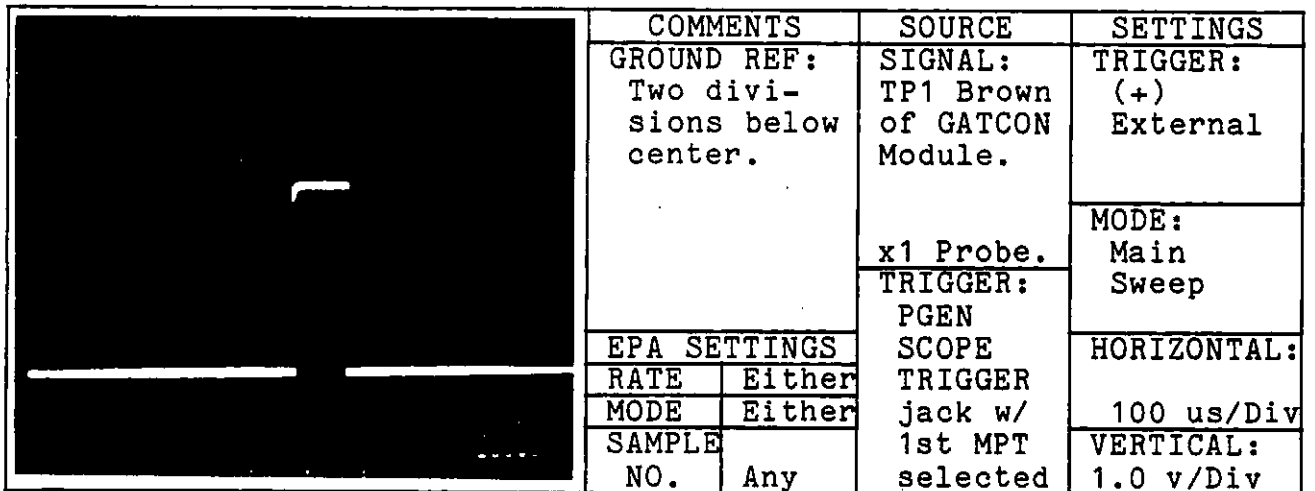
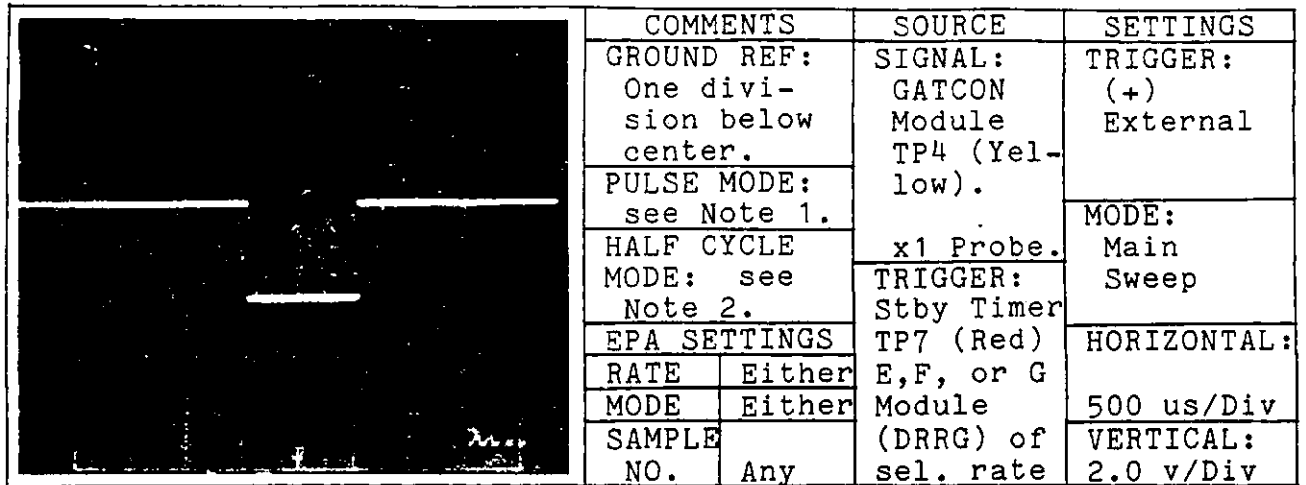


Figure 5.21. Peak Detector Reset Waveform



Notes: 1. Gate moves in time from pulse to pulse. 2. Gate width increases with sample number.

Figure 5.22. Data Strobe Waveform

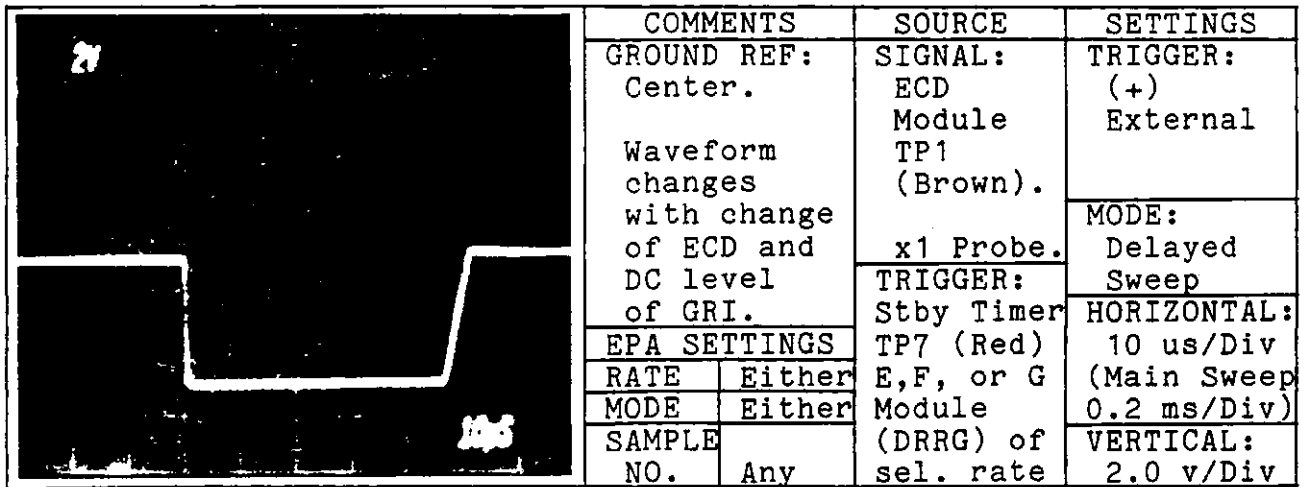


Figure 5.23. ECD Ramp Voltage Waveform

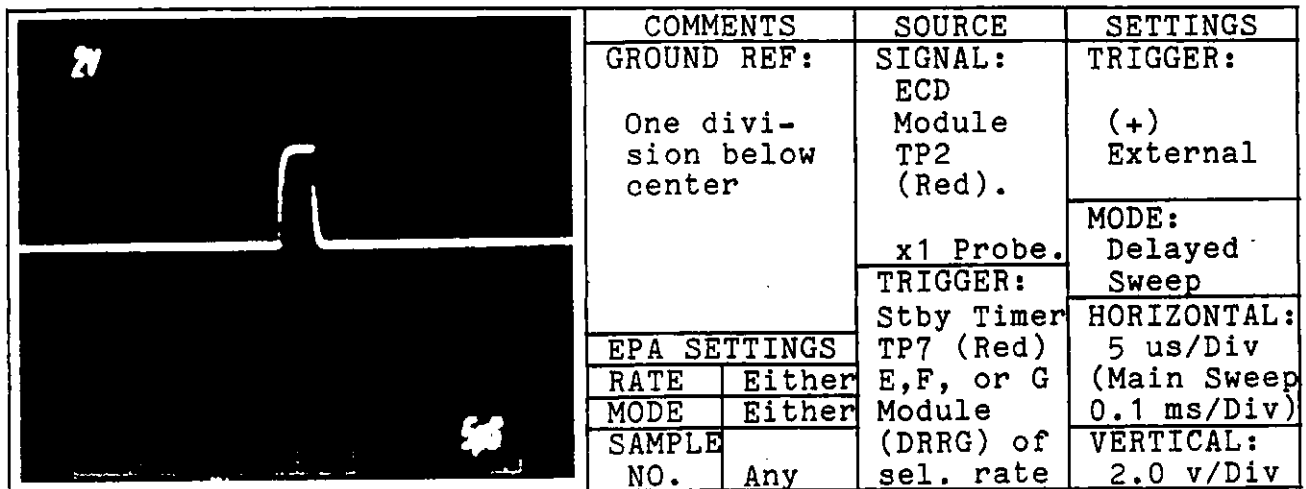


Figure 5.24. MPT Count and Select Strobe Generator Waveform

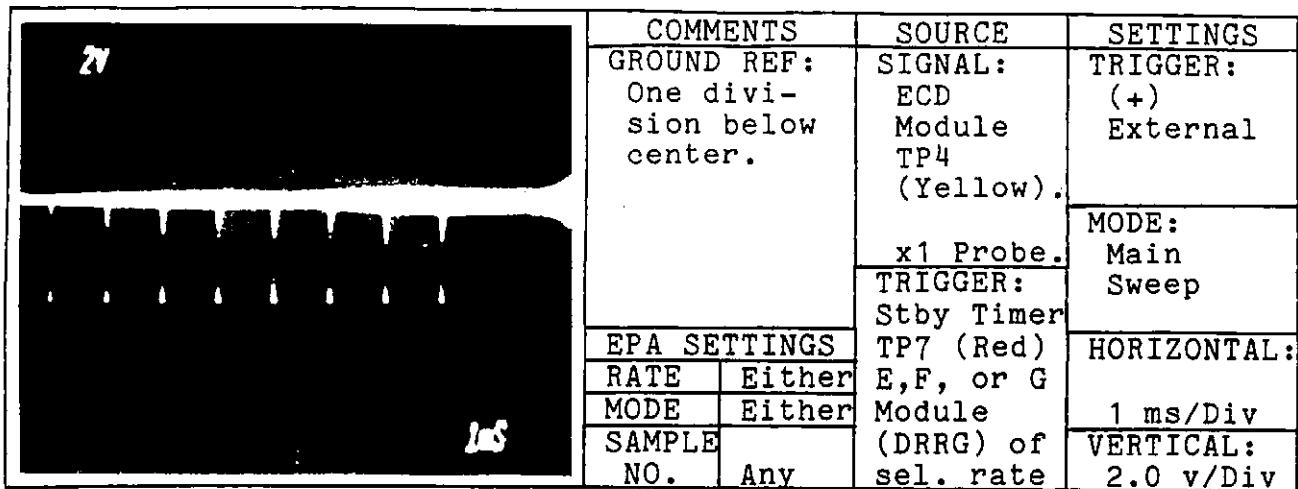


Figure 5.25. MPT Count and Select (Output of U17) Waveform

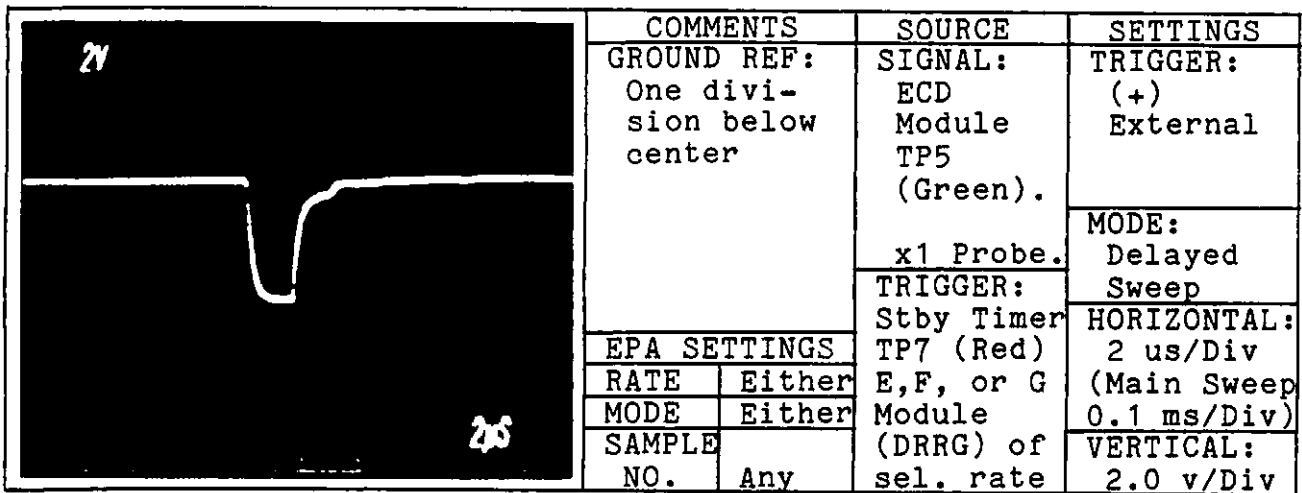


Figure 5.26. Half Cycle Pulse Select Waveform

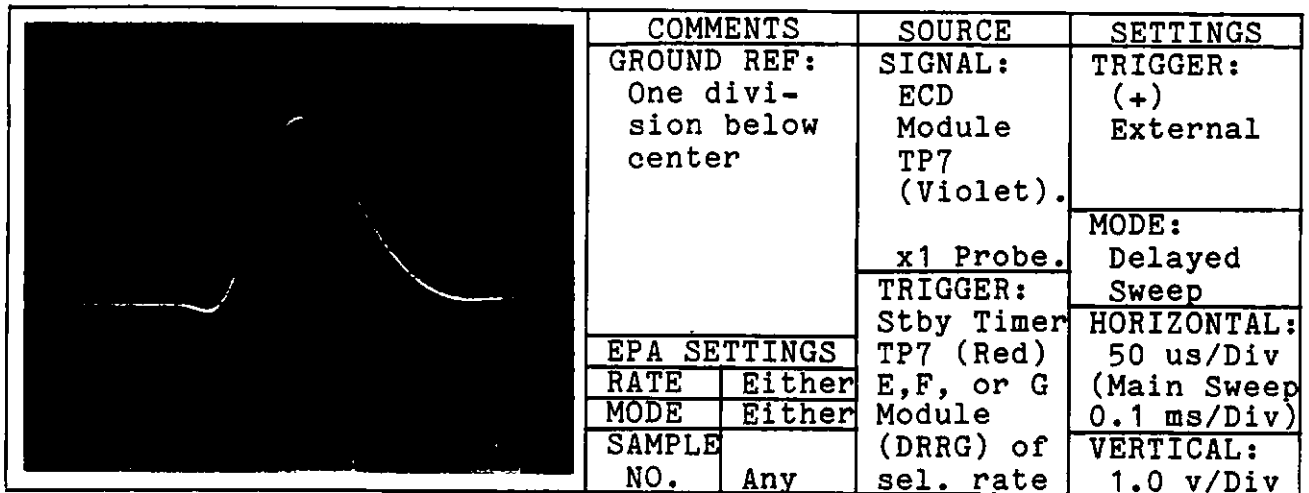


Figure 5.27. Low Pass Filter Output to Envelope Hard Limiter Waveform

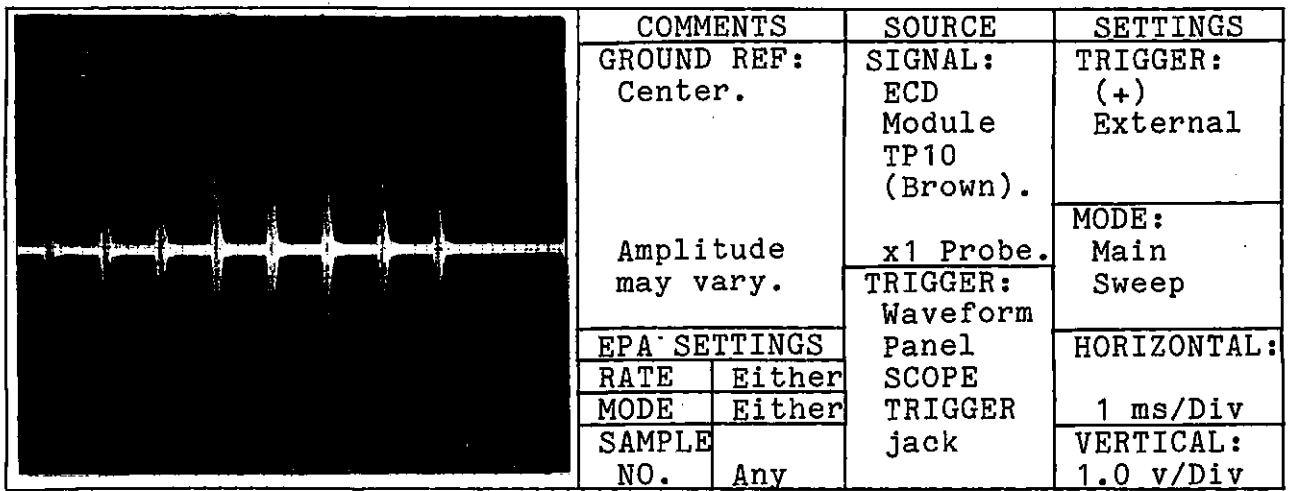
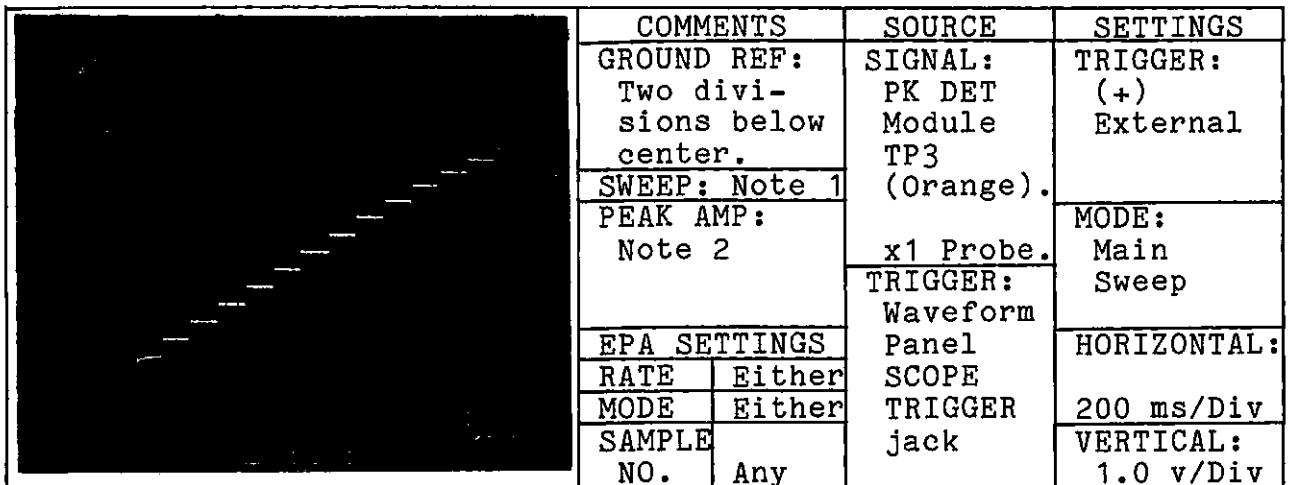


Figure 5.28. Attenuated RF



Notes: 1. Entire waveform may not be retained for complete sweep (sweep speed extremely slow). 2. Dependent upon half cycle selected and transmitter output.

Figure 5.29. Peak Volts Waveform

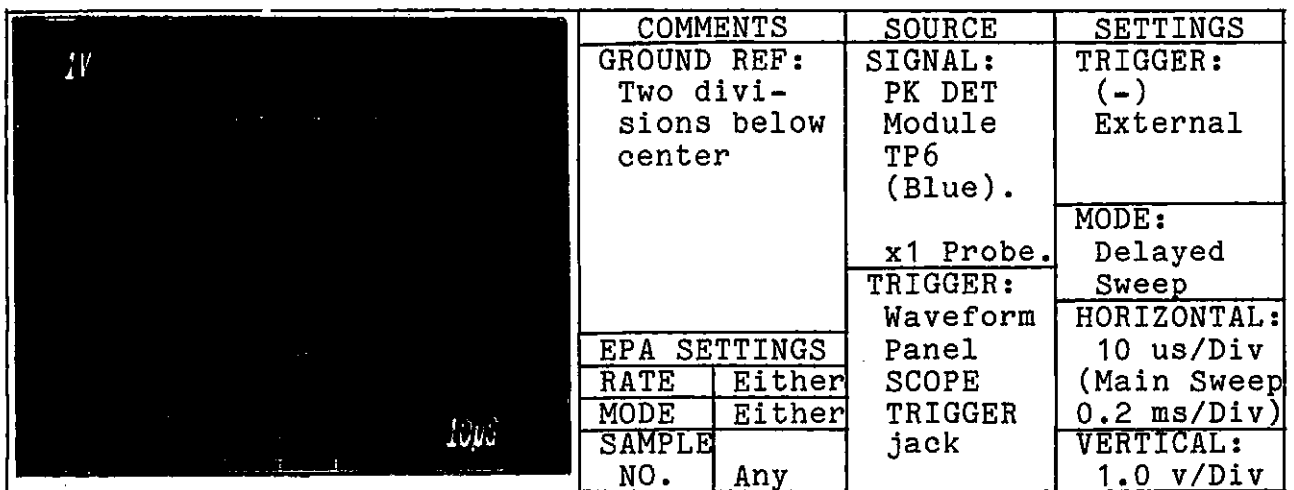


Figure 5.30. Count Waveform

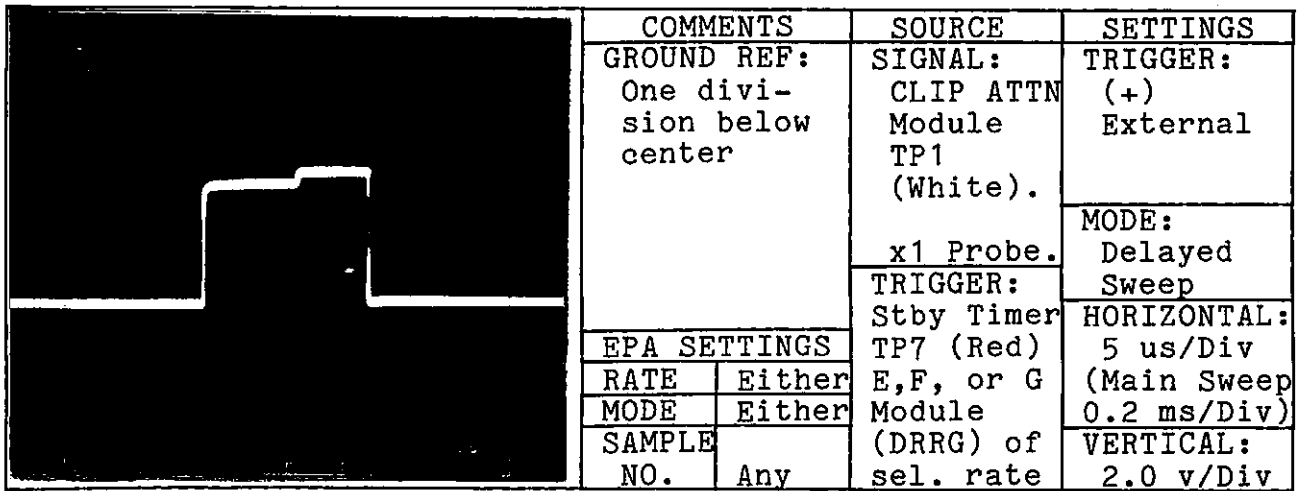


Figure 5.31. Switching Gate Output to Envelope Hard Limiter Waveform

5.3.2.3 Pulse Generator. Figures 5.32 and 5.32a show the voltage test and adjustment points of the power supply in the PGEN. Figure 5.33 shows the locations of the test points of the modules of the PGEN. Figure 5.33 also shows the location of various potentiometers of the W0678-19B/GR DROOP module. Figures 5.34 through 5.47 show the waveforms of the various test points of the PGEN modules. All waveforms are shown with the timers configured for a secondary station.

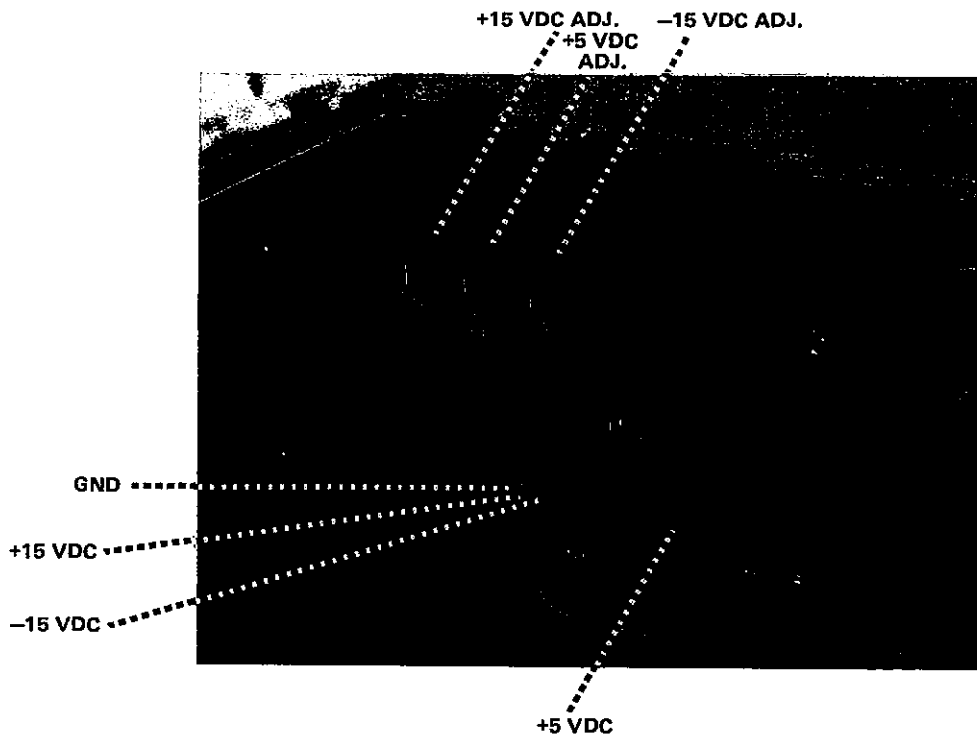


Figure 5.32. Voltage Test Point and Adjustment Locations of the PGEN Power Supply

PULSE GENERATOR

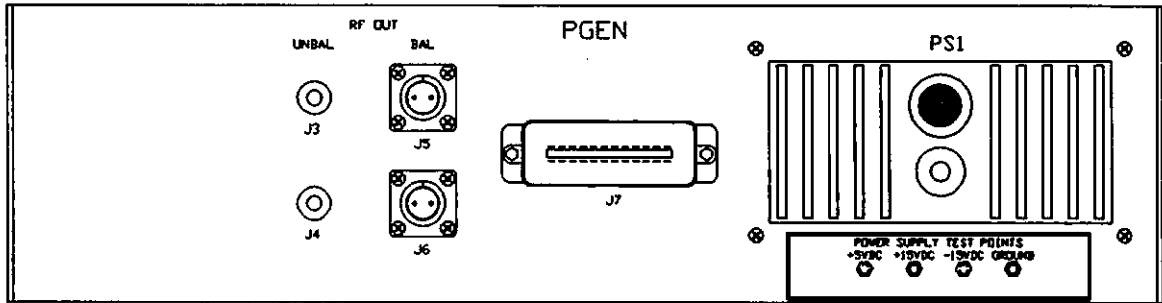


TABLE 1

PGEN POWER SUPPLY WIRE HOOK-UP CONNECTION POINT(S) FOR TEST JACKS			
POWER SUPPLY AND VOLTAGES	CONNECTOR (XPS1)	TEST JACK DESTINATION	
PS1	+5VDC	PIN 12	TP1 RED
	+15VDC	PIN 2	TP2 BROWN
	-15VDC	PIN 3	TP3 BLUE
	GROUND	PIN 1	TP4 GREEN

TABLE 2

	NOMINAL VOLTAGE	UPPER LIMIT	LOWER LIMIT	AC RIPPLE
PS1	+5.0V	+5.25V	+4.75V	1.4mV
	+15.0V	+15.5V	+14.5V	2.8mV
	-15.0V	-15.5V	-14.5V	2.8mV

Figure 5.32a Power Supply Voltage Test Points
of the Pulse Generator



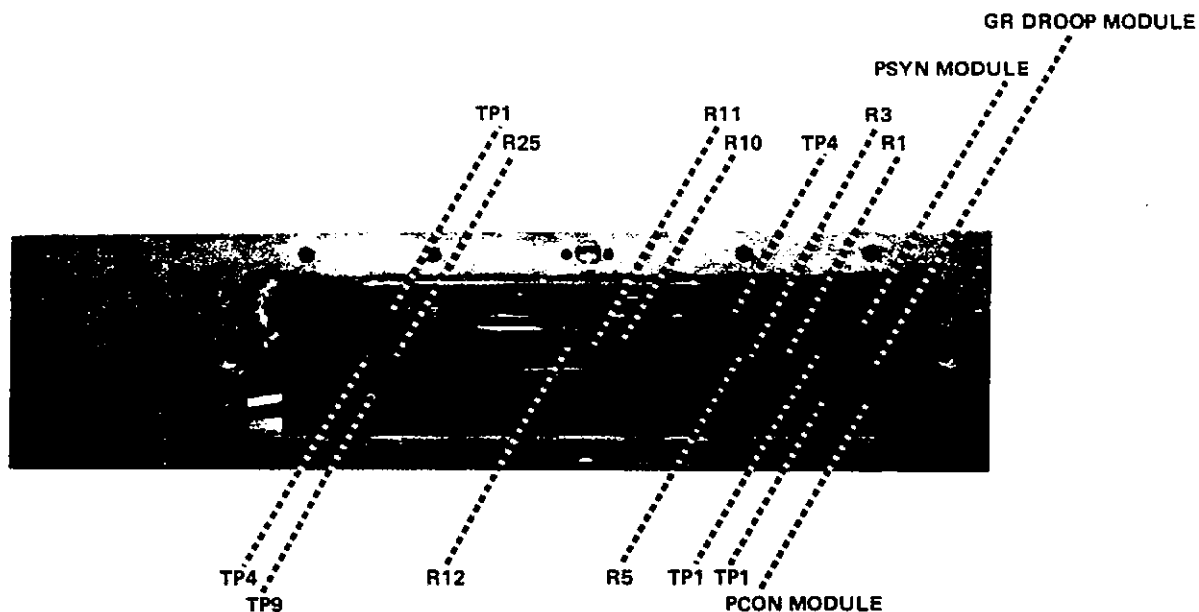


Figure 5.33. Test Point and Potentiometer Locations of the PGEN Modules

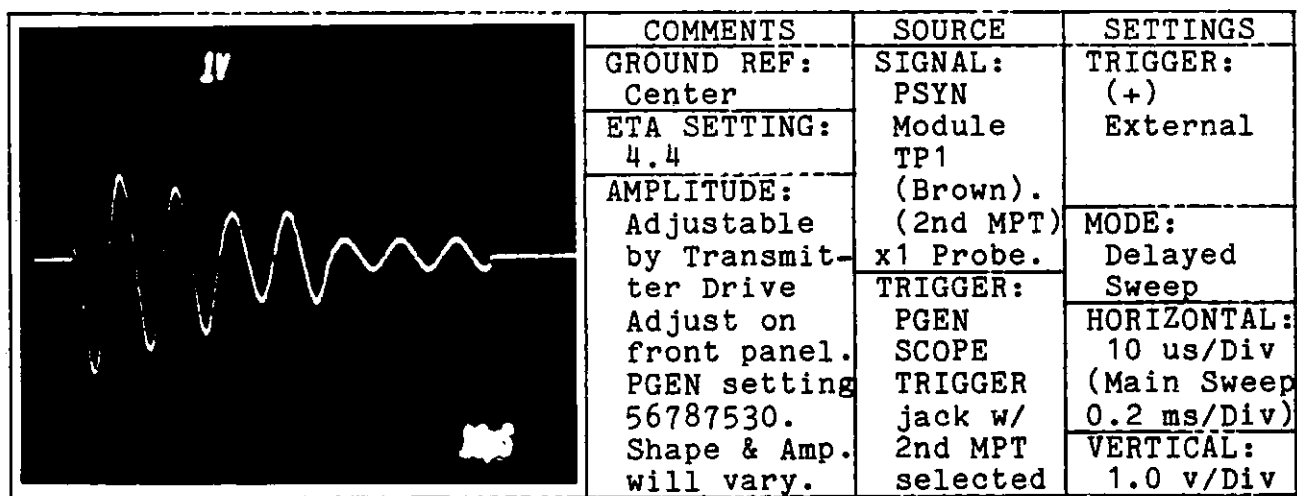


Figure 5.34. Transmitter Drive Waveform (2nd MPT)

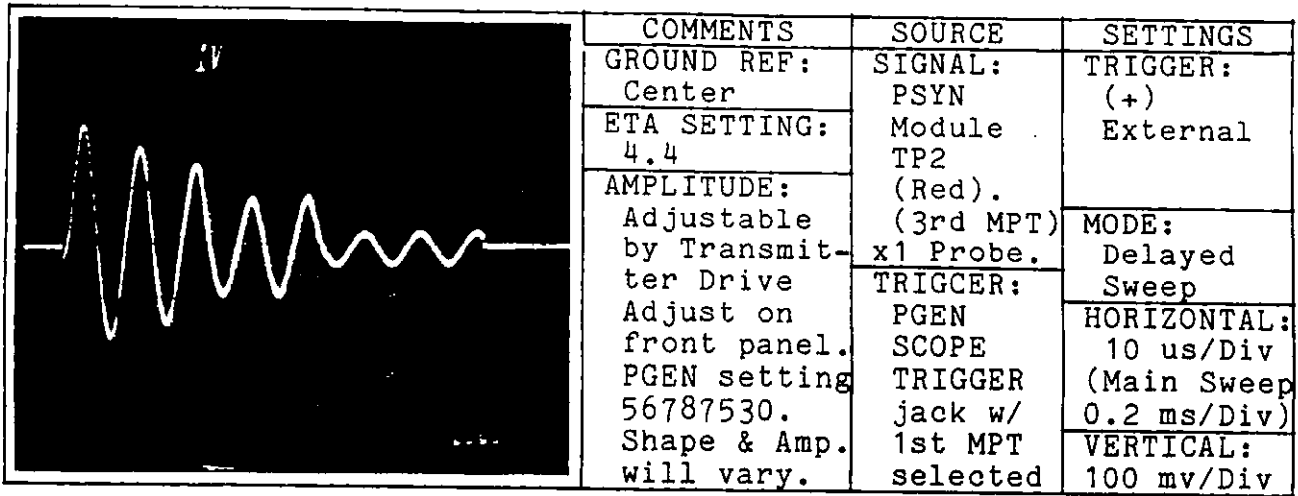


Figure 5.35. Transmitter Drive Waveform (1st MPT)

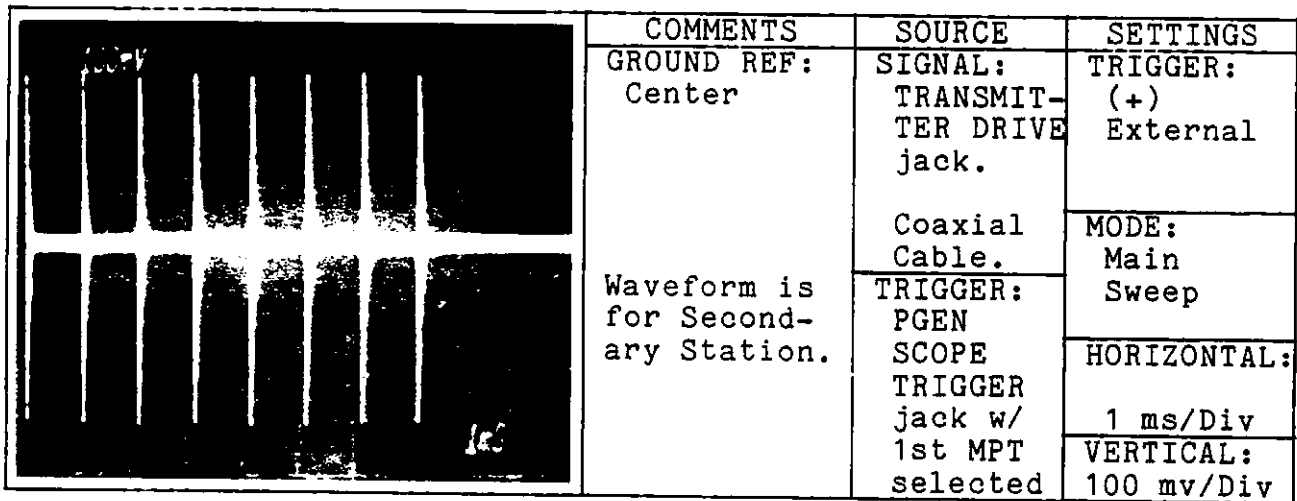


Figure 5.36. Transmitter Drive Waveform

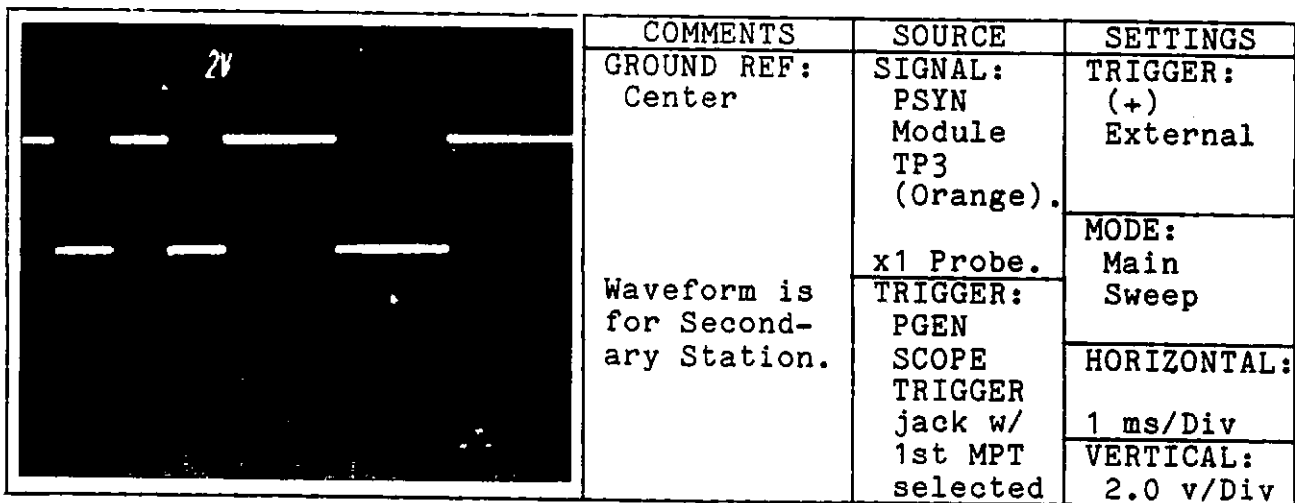


Figure 5.37. Phase Code Waveform (Positive Slope Triggered)

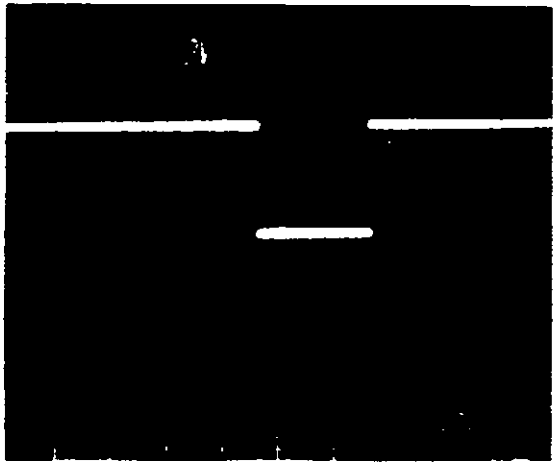
COMMENTS	SOURCE	SETTINGS
 <p>GROUND REF: Center</p> <p>Waveform is for Second- ary Station.</p>	SIGNAL: PSYN Module TP3 (Orange).	TRIGGER: (-) External
	x1 Probe.	MODE: Main Sweep
	TRIGGER: PGEN SCOPE TRIGGER jack w/ 1st MPT selected	HORIZONTAL: 1 ms/Div
		VERTICAL: 2.0 v/Div

Figure 5.38. Phase Code Waveform (Negative Slope Triggered)

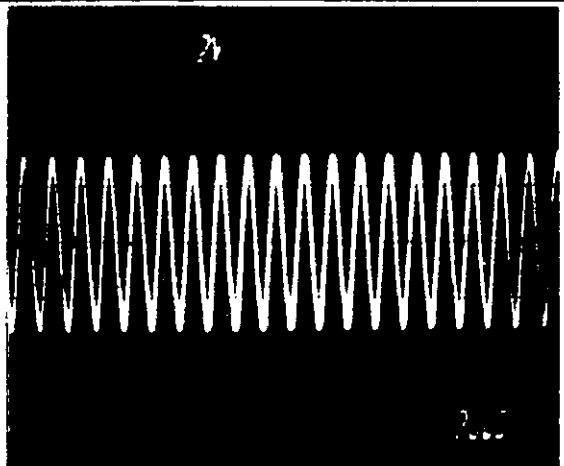
COMMENTS	SOURCE	SETTINGS
 <p>GROUND REF: Center</p> <p>Waveform is for Second- ary Station.</p>	SIGNAL: PCON Module TP2 (Red).	TRIGGER: (+) External
	x1 Probe.	MODE: Main Sweep
	TRIGGER: PGEN SCOPE TRIGGER jack w/ 1st MPT selected	HORIZONTAL: 20 us/Div
		VERTICAL: 2.0 v/Div

Figure 5.39. 100 kHz Input

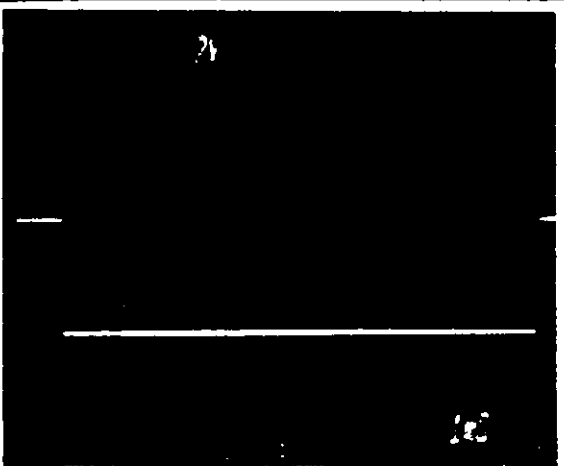
COMMENTS	SOURCE	SETTINGS
 <p>GROUND REF: Center</p> <p>Waveform is for Second- ary Station.</p>	SIGNAL: PCON Module TP4 (Yellow).	TRIGGER: (+) External
	x1 Probe.	MODE: Delayed Sweep
	TRIGGER: PGEN SCOPE TRIGGER jack w/ 1st MPT selected	HORIZONTAL: 1 ms/Div (Main Sweep 20 ms/Div)
		VERTICAL: 2.0 v/Div

Figure 5.40. Local Interval

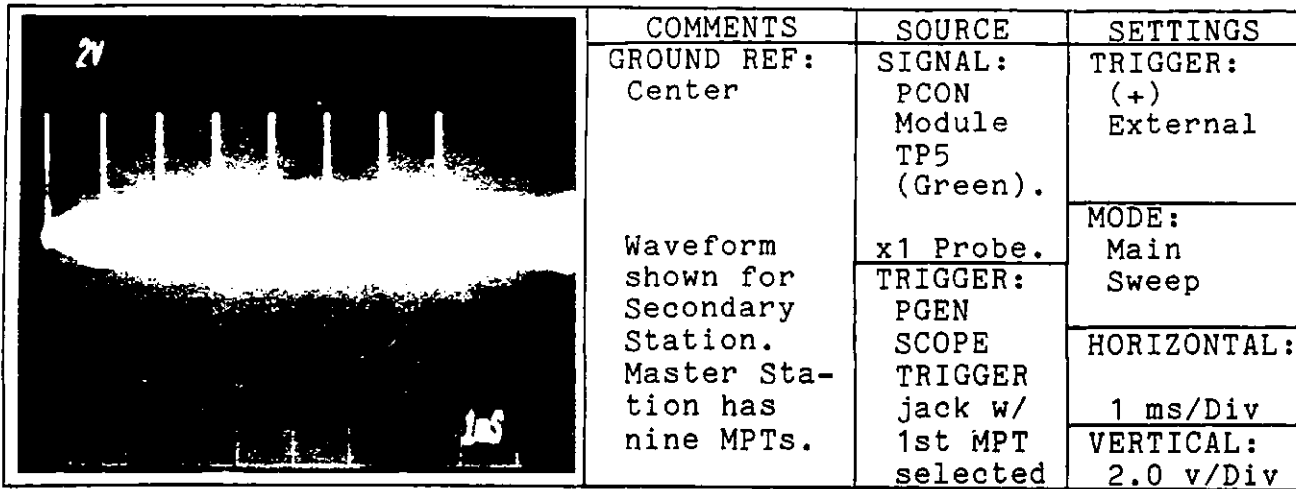


Figure 5.41. MPTs

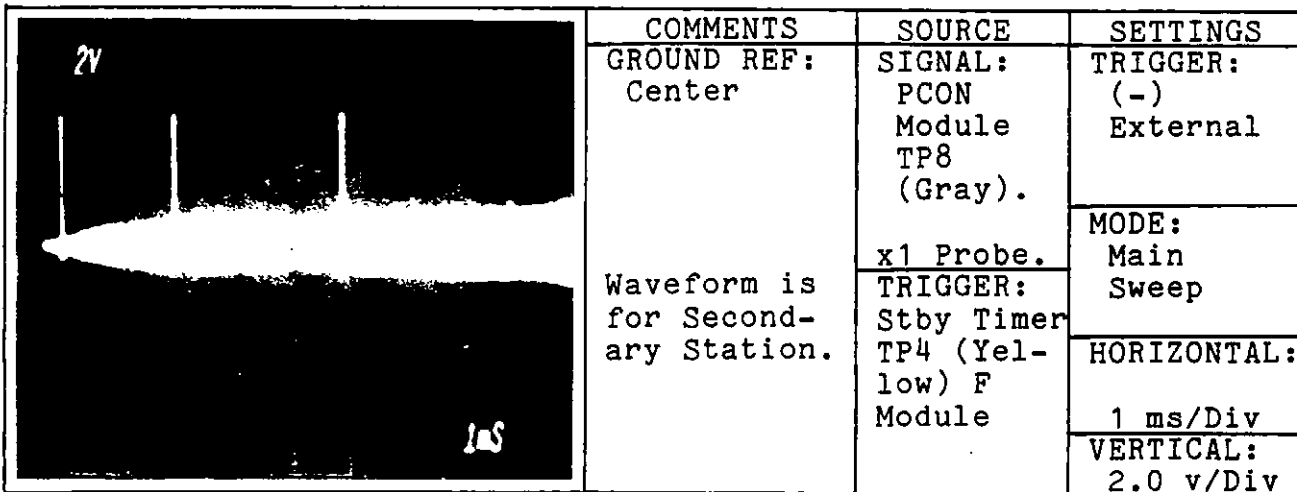


Figure 5.42. Phase Code Reset Waveform (Negative Slope Triggered)

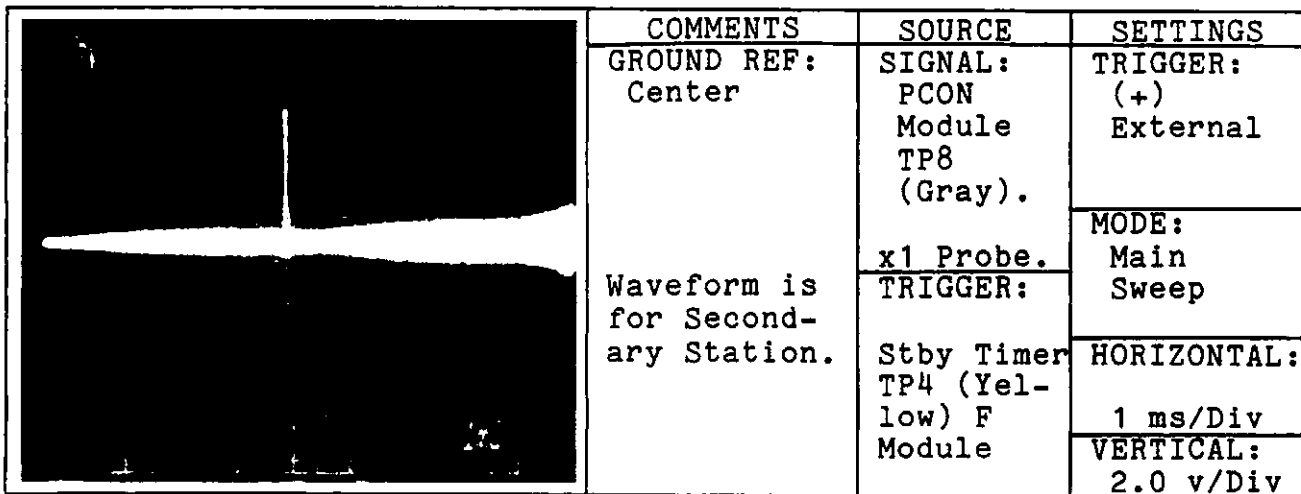


Figure 5.43. Phase Code Reset Waveform (Positive Slope Triggered)

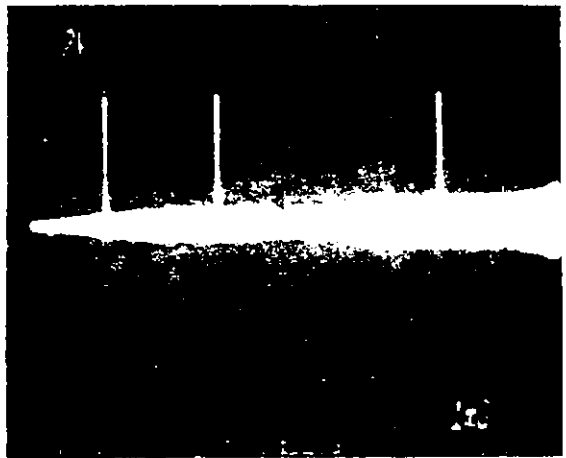
	COMMENTS	SOURCE	SETTINGS
	GROUND REF: Center	SIGNAL: PCON Module TP9 (White).	TRIGGER: (-) External
	Waveform is for Second- ary Station.	x1 Probe.	MODE: Main Sweep
		TRIGGER:	HORIZONTAL: 1 ms/Div VERTICAL: 2.0 v/Div
		Stby Timer TP4 (Yel- low) F Module	

Figure 5.44. Phase Code Set Waveform (Negative Slope Triggered)

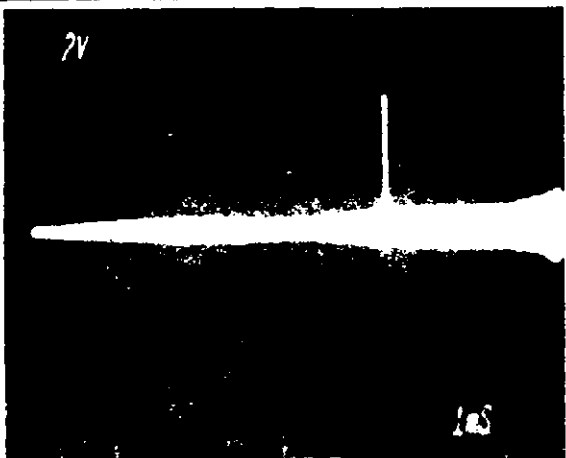
	COMMENTS	SOURCE	SETTINGS
	GROUND REF: Center	SIGNAL: PCON Module TP9 (White).	TRIGGER: (+) External
	Waveform is for Second- ary Station.	x1 Probe.	MODE: Main Sweep
		TRIGGER:	HORIZONTAL: 1 ms/Div VERTICAL: 2.0 v/Div
		Stby Timer TP4 (Yel- low) F Module	

Figure 5.45. Phase Code Set Waveform (Positive Slope Triggered)

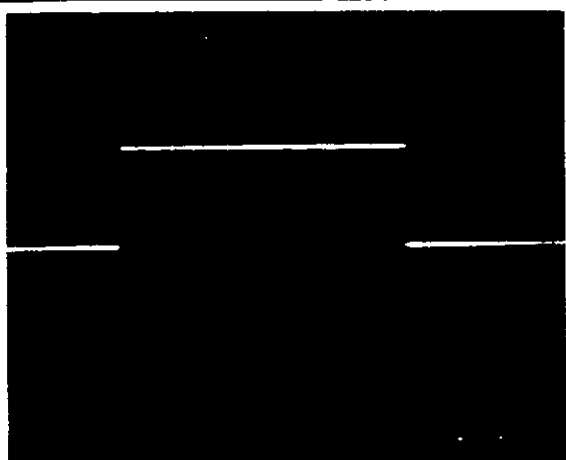
	COMMENTS	SOURCE	SETTINGS
	GROUND REF: Center	SIGNAL: GR DROOP Module TP1 (Brown).	TRIGGER: (+) External
	Waveform is for Second- ary Station.	x1 Probe.	MODE: Delayed Sweep
		TRIGGER:	HORIZONTAL: 100 us/Div (Main Sweep 0.2 ms/Div) VERTICAL: 2.0 v/Div
		PGEN SCOPE TRIGGER jack w/ 1st MPT selected.	

Figure 5.46. Gate-H Waveform

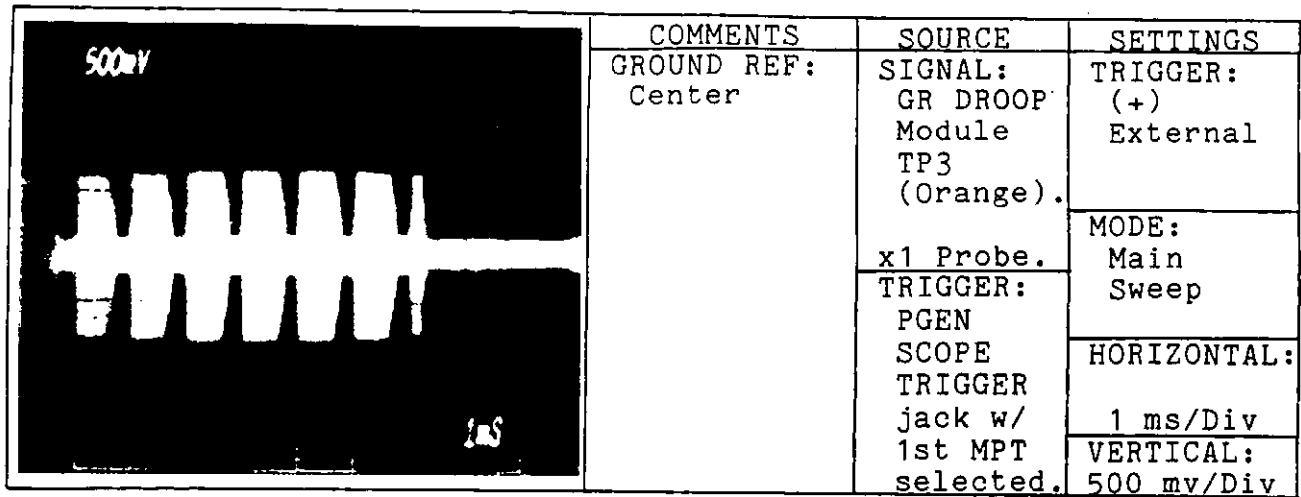


Figure 5.47. 100 kHz AM Tail

5.3.3 Adjustments and repair. If the following adjustments cannot be performed on the module involved, refer to the appropriate troubleshooting guide (paragraph 5.3.1) for instructions. If the module is not listed in the troubleshooting chart, replace the module as directed by E/GICP instructions.

5.3.3.1 Transmitter Coupler Control. Table 5.1 lists the voltage limits of both power supplies of the TCC. The TCC power supply adjustments are as follows (see Figure 5.12 for adjustment locations):

Table 5.1. TCC Power Supply Voltage Limits

POWER SUPPLY	NOMINAL VOLTAGE	UPPER LIMIT	LOWER LIMIT
PS1	5.0 Volts	5.25 Volts	4.75 Volts
	-15.0 Volts	-15.5 Volts	-14.5 Volts
	+15.0 Volts	+15.5 Volts	+14.5 Volts
PS2	+24.0 Volts	+24.5 Volts	+23.5 Volts

a. For PS1-Type AN-3005-AM:

(1) Measure the voltage between pin 2 and ground. Adjust the +15V control on the power supply for a nominal +15 VDC.

(2) Measure the voltage between pin 3 and ground. Adjust the -15V control on the power supply for a nominal -15 VDC.

(3) Measure the voltage between pin 12 and ground. Adjust the +5V control on the power supply for a nominal +5 VDC.

(4) Measure the AC ripple on pins 2, 3, and 12. If the AC ripple is more than 1.4 mV on pin 12, or more than 2.8 mV on pin 2 or 3, replace the power supply, and recheck the adjustments.

b. For PS2-Type OEM-2B24-1:

(1) Measure the voltage between the positive terminal post and ground. Adjust R8 for a nominal +24 VDC.

(2) If the power supply cannot be adjusted, or if the AC ripple is in excess of 4.2 mV replace the power supply, and recheck the adjustments.

5.3.3.2 Electrical Pulse Analyzer. The following are adjustment procedures for the PS1 Power Supply and Clip Attenuator module:

CAUTION

These procedures require the partial removal of the EPA from the rack. Cables are still attached to the rear of the EPA.

a. Refer to paragraph 5.3.3.1.a for the adjustment procedures for the PS1 Power Supply. PS2 +5V Power Supply is not adjustable or repairable.

b. DPM Calibration (R6 of Clip Attenuator module):

(1) Partially remove the chassis from the cabinet to permit access to the interior via the top panel. Leave all input/output cables connected to the EPA.

(2) Set the MODE SELECT switch to the PULSE NUMBER position, and the SAMPLE NUMBER switch to 100.

(3) Disable the cycle compensation loop by jumpering TP2 (Orange) to TP6 (Black) on the M Card(s) of the operate timer(s).

CAUTION

If TP2 (Orange) on the M Card is not jumpered to ground, timing shifts due to the cycle compensation loop may occur.

(4) Remove the chassis cover from the EPA.

WARNING

Hazardous voltages are present in the RF return cable.

(5) Locate and disconnect the keyed twin-axial connector in the Current Transformer cable (as close to the Current Transformer as possible).

(6) Using a 100 ohm 5%, 1/2W resistor and a calibrated oscilloscope, measure the zero-to-peak voltage of the first pulse of the transmitted pulse group. Ensure that the resistor is placed across the plus and minus pins of the twin-axial connector (refer to Figure 2.20). If the twin-axial cable was disconnected in the transmitter building, use the Transmitter Scope Trigger for the external trigger to the oscilloscope. If the cable was disconnected in the timer room, use the PGEN Scope Trigger.

(7) Remove the resistor and reconnect the twin-axial connector.

(8) Adjust the potentiometer (R6) (refer to Figure 5.14 for the location of R6) until the pulse peak reading on the EPA display is the same as the value (+1 volt) as obtained in step (6). Since the volt/ampere ratio of the Current Transformer (Pearson Model #1705) is 1/10, the peak current on the antenna may be obtained by multiplying this reading by ten.

(9) Replace the top cover on the EPA and re-install. Do not perform this step, if proceeding directly to the Clip Attenuator Gate adjustment.

(10) Re-enable the cycle compensation loop by removing the jumper(s) between TP2 (Orange) and TP6 (Black) on the M Card(s) of the operate timers.

c. Clip Attenuator Gate adjustment (R10 of the Clip Attenuator module):

(1) On Channel A of the oscilloscope, monitor the Sample Gate at J3, on the EPA front panel. If the Sample Gate is not present, refer to paragraph 5.3.1.4.

(2) Place the MODE SELECT switch (S2) in the HALF CYCLE NUMBER position. Adjust the SAMPLE NUMBER switch (S3) to position 1 for the pulse number and positions 08 for the half-cycle number.

(3) Remove the chassis mounting screws and pull the EPA out so that it protrudes from the cabinet. Remove the top cover of the chassis. This step was done if the DPM was just calibrated.

(4) On Channel B of the oscilloscope, monitor the Clip Attenuator Gate on the white test point (TP1) (refer to Figure 5.14) on the Clip Attenuator module.

(5) Adjust R10 on the Clip Attenuator module so that the sample gate overlaps with the leading edge of the Clip Attenuator Gate (refer to Figure 2.19.a).

(6) Monitor only the Clip Attenuator Gate and adjust R10 so that X=Y (refer to Figure 2.19.b).

5.3.3.3 Pulse Generator. Refer to paragraph 5.3.3.1 for the adjustments of the PGEN power supply. Paragraph 2.6.5 contains the adjustments for the W0678-19B/GR DROOP module. The following steps are the checks that can be performed on the front panel multi-section switches.

- a. Remove the power to the Pulse Generator.
- b. Remove all printed circuit modules.
- c. Measure the resistance across pins 4 and 6 (ground) of the individual switch-section connector. Refer to Figure 5.48 for the connector pin location and numbering. With the switch-section in position 0, 2, 4, 6, or 8, the resistance should be 100k ohms or greater. With the switch-section in position 1, 3, 5, 7, or 9, the resistance should be 800 ohms or less.

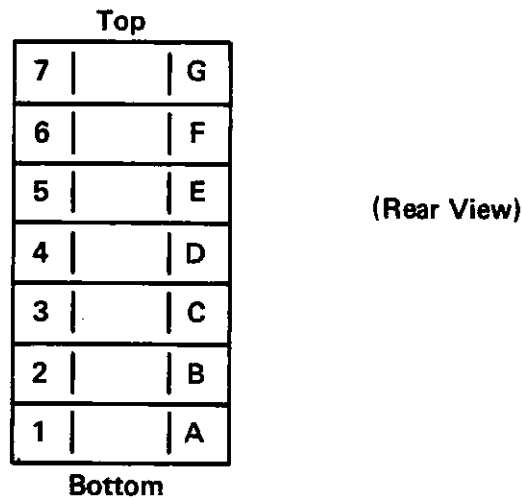


Figure 5.48. Individual Switch Section Connector Diagram

- d. Move the positive lead to pin 3. With the switch-section in position 0, 1, 4, 5, 8, or 9, the resistance should be 100k ohms or greater. With the switch-section in position 2, 3, 6, or 7, the resistance should be 800 ohms or less.
- e. Move the positive lead to pin 2. With the switch-section in position 0, 1, 2, 3, 8, or 9, the resistance should be 100k ohms or greater. With the switch-section in position 4, 5, 6, or 7, the resistance should be 800 ohms or less.
- f. Move the positive lead to pin 1. With the switch-section in position 0, 1, 2, 3, 4, 5, 6, or 7, the resistance should be 100k ohms or greater. With the switch-section in position 8 or 9, the resistance should be 800 ohms or less.
- g. Repeat steps c-f for all 23 sections of S2 (PULSE SYNTHESIZER) and S3 (DROOP).



CHAPTER 6

PARTS LIST

6.1 Introduction. Table 6.1 lists all of the major components of the Transmitter Control Set. Table 6.2 provides the parts listing of each unit of the Transmitter Control Set. Table 6.3 lists the five digit manufacturer's code and the respective manufacturer.

Table 6.1. TCS, Reference Designations

UNIT	ASSEMBLY OR SUBASSEMBLY	REF DESIG
CY-7523/FPN-60	ELECTRICAL EQUIPMENT CABINET	1
SA-2063/FPN-60	SWITCH ASSEMBLY	1A1
C-9888/FPN-60	TRANSMITTER COUPLER CONTROL Chassis and Panel Assembly W0678-5/XMTR CON Transmitter Control Module W0678-6/XMTR CON DVR Transmitter Con- trol Driver Module W0678-13/Relay Assembly Type AN-3005-AM Power Supply (PS1) Type OEM-2B24-1 Power Supply (PS2)	1A2
TS-3550/FPN	ELECTRICAL PULSE ANALYZER Chassis and Panel Assembly W0678-3A/GATCON Gate Control Module W0678-4/PK DET Peak Detector Module W0678-18C/ECD ECD Module W0678-11A/CLP ATTN Clip Attenuator Module Digital Panel Meter Type AN-3005-AM Power Supply (PS1) Type UPM-5/1000B Power Supply (PS2)	1A3
SG-1099/FPN-60	PULSE GENERATOR Chassis and Panel Assembly W0678-1/PSYN Pulse Synthesizer Module W0678-19B/GR DROOP Group Droop Module W0678-20/GR DROOP Group Droop Module W0678-2/PCON Pulse Control Module Type AN-3005-AM Power Supply	1A4-1A7
SB-4156/FPN-60	WAVEFORM PANEL	1A8
J-3353/FPN-60	INTERFACE UNIT	1A9
	EPA JUNCTION BOX	1A10
	TCC JUNCTION BOX	1A11

Table 6.2. Parts List

REF SYM	NAME AND DESCRIPTION	MFR OR SOURCE	MFR's DATA
<u>1</u>	<u>CY-7523/FPN-60 Electrical Equipment Cabinet</u>	74156	PC-5213 CGV
J1	POWER STRIP	74156	PS-52
TB1	TERMINAL BLOCK, 10 Terminal	75382	602-10
<u>1A1</u>	<u>SA-2063/FPN-60 Switch Assembly</u>		
S1	SWITCH, SPST, Normally Closed	04009	OBA3
S2	Same as S1		
<u>1A2</u>	<u>C-9888/FPN-60 Transmitter Coupler Control</u>		
A1	W0678-5/XMTR CON, TRANSMITTER CONTROL PC Module		
A2	W0678-6/XMTR CON DVR, TRANSMITTER CONTROL DRIVER PC Module		
C1	CAPACITOR, 1 uf, 200 VDC	80114	2DF-M1
C2	Same as C1		
C3	Same as C1		
C4	Same as C1		
CR1	DIODE, Silicon	15238	1N914A
CR2	Same as CR1		
CR3	Same as CR1		
CR4	Same as CR1		
CR5	Same as CR1		
CR6	Same as CR1		
CR7	DIODE, Silicon	15238	1N4005
DS1A	LAMP, Incandescent, 28 VDC	71744	CM387
DS1B	Same as DS1A		
DS1C	Same as DS1A		
DS1D	Same as DS1A		
DS2A	Same as DS1A		
DS2B	Same as DS1A		
DS2C	Same as DS1A		
DS2D	Same as DS1A		
DS3A	Same as DS1A		
DS3B	Same as DS1A		
DS3C	Same as DS1A		
DS3D	Same as DS1A		
DS4A	Same as DS1A		
DS4B	Same as DS1A		
DS4C	Same as DS1A		
DS4D	Same as DS1A		
DS5A	Same as DS1A		
DS5B	Same as DS1A		
DS5C	Same as DS1A		
DS5D	Same as DS1A		
DS6A	Same as DS1A		
DS6B	Same as DS1A		
DS6C	Same as DS1A		
DS6D	Same as DS1A		

Table 6.2. Parts List
(ROS Modification)

Ref Symbol	Name and Description	Mfr or Source	Mfr's Data
<u>1A1</u>	<u>SA-2063/FPN-60A(V)</u> <u>Switch Assembly</u>	04009	0BA3
TB1	Barrier Strip, Terminal	71785	2-540
K1	Relay, 4PDT, 12VDC	77342	KHU17D11-12
XK1	Socket, Relay	08510	SL715



Table 6.2. Parts List
(Continued)

Ref Symbol	Name and Description	Mfr or Source	Mfr's Data
DS7A	Same as DS1A		
DS7B	Same as DS1A		
DS7C	Same as DS1A		
DS7D	Same as DS1A		
DS8A	Same as DS1A		
DS8B	Same as DS1A		
DS8C	Same as DS1A		
DS8D	Same as DS1A		
DS9A	Same as DS1A		
DS9B	Same as DS1A		
DS9C	Same as DS1A		
DS9D	Same as DS1A		
J1	Connector, Receptacle, Box Mounting Flange	02660	MS3102A22-14P
J2	Connector, Receptacle, Panel	02660	26-4401-24P
J3	Connector, Receptacle, BNC Bulkhead	02660	UG-1094/U
J4	Same as J3	02660	31-010
K1	Relay, 4PDT, 24 VDC	77342	KHS-17011-24
K2	Relay, Latching, 4PDT, 24VDC	77342	K8P17D
K3	Same as K1		
K4	Relay, 4PDT, 120 VAC	77342	KHS-17A11-120
K5	Same as K4		
K6	Same as K4		
K7	Same as K4		
LS1	Sonalert Warbler	06124	SC-628W
MP1	Card Guide, Nylon	23880	1650F
MP2	Same as MP1		
MP3	Same as MP1		
MP4	Same as MP1		
PS1	Power Supply, +5VDC, ±15VDC,	31814	AN-3005-AM
PS1F1	Fuse, Slo-BLo, 1 Amp, 125 V, 3 AG	75915	313001
PS2	Power Supply, 24 VDC	24429	OEM-2B24-1
S1	Switch Assembly, (Amber)	96182	10EA1C1J3L (A)N1R1V13
S1A	Contact Assembly, Gold Con- tacts, Momentary Action	96182	10EF10
S1B	Switch Cover	96182	10E534
S2	Switch Assembly, (Yellow)	96182	10EA1C1J3L (Y)N1R1V14
S2A	Same as S1A		
S2B	Same as S1B		
S3	Switch, Pushbutton, SPST, Miniature	70255	MSPS-103C
S4	Switch Assembly	96182	10EA1C2F3J1 (A)L1N1R13
XA1	Connector, Edge, 86 Pin	00779	67015-6
XA2	Same as XA1		
XDS1	Lamp Assembly, (Green)	96182	10EA2C1J3L (G)N1R1V13
XDS2	Lamp Assembly, (Green, White)	96182	10EA2C1J3L (GW)N2R1V16

Table 6.2. Parts List
(Continued)

Ref Symbol	Name and Description	Mfr or Source	Mfr's Data
XDS3	Lamp Assembly, (Yellow)	96182	10EA2C1J3L (Y)N1R1V14
XDS4	Same as XDS2		
XDS5	Lamp Assembly, (Red)	96182	10EA2C1J3L (R)N2R1V17
XDS6	Lamp Assembly, (Red)	96182	10E2C1J3L (R)N1R1V13
XK1	Socket, relay, with Retaining Clips	77342	9KH1
XK2	Socket, Relay	77342	77-M1P20
XK3	Same as XK1		
XK4	Same as XK1		
XK5	Same as XK1		
XK6	Same as XK1		
XK7	Same as XK1		
XPS1	Connector, Edge, 30-Pin	05574	2VK15D/1-1
XPS1A	Key, Polarizing	05574	091-0024-000
<u>1A3</u>	<u>TS-3550/FPN Electrical Pulse Analyzer</u>		
A1	W0678-3A/GATCON, Gate Control PC Module		
A2	W0678-18C/ECD, ECD PC Module		
A3	W0678-4/PK DET, Peak Detector PC Module		
A4	W0678-11A/CLP ATT, Clip Attenuator PC Module		
CR1	Diode, Silicon	15238	1N914
DS1	Diode, Light Emitting, Yellow	50522	MV-5353
DS2	Diode, Light Emitting, Green	50522	MV-5253
DS3	Same as DS2		
DS4	Same as DS2		
J1	Connector, Receptacle, BNC Bulkhead	02660	UG-1094/U
J2	Same as J1		
J3	Same as J1		
J4	Same as J1		
J5	Same as J1		
J6	Connector, Receptacle, Panel	02660	26-4401-24P
J7	Connector, Receptacle, Panel	02660	26-4401-24S
J8	Same as J1		
J9	Same as J1		
J10	Connector, Receptacle, Box Mounting Flange	02660	MS3112E8-3P
J11	Same as J1		
J12	Same as J1		
J13	Same as J1		
M1	Meter, Digital, Panel Mntg	50721	DM-2000-B
MP1	Card Guide, Nylon	23880	1650F
MP2	Same as MP1		
MP3	Same as MP1		
MP4	Same as MP1		

Table 6.2. Parts List
(Continued)

Ref Symbol	Name and Description	Mfr or Source	Mfr's Data
MP5	Same as MP1		
MP6	Same as MP1		
PS1	Power Supply, +5VDC, +15VDC	31814	AN-3005-AM
PS1F1	Fuse, Slo-Blo, 1 Amp, 125 V 3 AG	75915	313001
PS2	Power Supply, 5 VDC	50721	UPM-5/1000B
R1	Resistor, Variable, 1k, 1/2W	12697	RV6LAYS102A
S1	Switch, Toggle, Miniature, SPDT	70255	MST-105D
S2	Same as S1		
S3	Digi Switch Assembly, 3 Section BCD	07126	N3-U-238
S5	Same as S1		
S6	Switch, Toggle, Miniature DPDT	70255	JMT-221
TB1	Barrier Strip, 10-Terminal	75382	600A-10
XA1	Connector, Edge, 10-Pin, Double Readout	00779	67015-6
XA2	Same as XA1		
XA3	Same as XA1		
XA4	Connector, Edge, 10-Pin, Double Readout	71785	251-15-30-160
XM1	Connector, Edge, 36-Pin	05574	3VH18/1JN-5
XPS1	Connector, Edge, 30-Pin	05774	2VK15D/1-1
XPS1A	Key, Polarizing	05574	091-0024-000
XPS2	Mating Socket	50721	MS-7
XS3-A	Connector, Edge, 10-Pin Single Readout	71785	251-10-30-170
XS3-B	Same as XS3-A		
XS3-C	Same as XS3-A		
<u>1A4-</u>	<u>SG-1099/FPN-60(V) Pulse</u>		
<u>1A7</u>	<u>Generator</u>		
A1	W0678-1/PSYN, Pulse Synthe- sizer PC Module		
A2	W0678-19B/GR DROOP, Group Droop PC Module		
	W0678-20/GR DROOP, Group Droop PC Module		
A3	W0678-2/PCON, Pulse Control PC Module		
DS1	Diode, Light Emitting, Green	50522	MV-5253
DS2	Diode, Light Emitting, Red	50522	MV-5253
J1	Connector, Receptacle, BNC Bulkhead	02660	UG-1094/U
J2	Same as J1		
J3	Same as J1		

Table 6.2. Parts List
(Continued)

Ref Symbol	Name and Description	Mfr or Source	Mfr's Data
J4	Same as J1		
J5	Connector, Receptacle, Twinax	02660	UG-422/U
J6	Same as J5		
J7	Connector, Receptacle, Panel	02660	26-4401-24P
MP1	Card Guide, Nylon	23880	1650F
MP2	Same as MP1		
MP3	Same as MP1		
MP4	Same as MP1		
MP5	Same as MP1		
MP6	Same as MP1		
PS1	Power Supply, +5VDC, ±15VDC	31814	AN-3005-AM
PS1F1	Fuse, Slo-Blo, 1 Amp, 125V, 3AG	75915	313001
R1	Resistor, Variable, 5K	32997	2735-1-502M
R2	Resistor, Variable, 2.5K, with dial	12697	G2JA-2500
S1	Switch, Toggle, Miniature, SPDT	70255	MST-105D
S2	Digiswitch Assembly, less switches and diodes	07126	7882/107-16
S3	Digiswitch Assembly, less switches and diodes	07126	7882/107-7
XA1	Connector, Edge, 86-pin	00779	67015-6
XA2	Same as XA1		
XA3	Same as XA1		
XPS1	Connector, Edge, 30-pin	05574	2VK15D/1-1
XPS1A	Key, Polarizing	05774	091-0024-000
XS2-1	Connector, Edge, 7-pin	95238	
XS2-2	Same as XS2-1		
XS2-3	Same as XS2-1		
XS2-4	Same as XS2-1		
XS2-5	Same as XS2-1		
XS2-6	Same as XS2-1		
XS2-7	Same as XS2-1		
XS2-8	Same as XS2-1		
XS2-9	Same as XS2-1		
XS2-10	Same as XS2-1		
XS2-11	Same as XS2-1		
XS2-12	Same as XS2-1		
XS2-13	Same as XS2-1		
XS2-14	Same as XS2-1		
XS2-15	Same as XS2-1		
XS2-16	Same as XS2-1		
XS3-1	Same as XS2-1		
XS3-2	Same as XS2-1		
XS3-3	Same as XS2-1		

Table 6.2. Parts List
(Continued)

Ref Symbol	Name and Description	Mfr or Source	Mfr's Data
XS3-4	Same as XS2-1		
XS3-5	Same as XS2-1		
XS3-6	Same as XS2-1		
XS3-7	Same as XS2-1		
<u>1A8</u>	<u>SB-4156/FPN-60(V) WaveFm Pnl</u>		
J1	Connector, Receptacle	02660	UG492A/U
J2	Same as J1		
J3	Same as J1		
J4	Sam3 as J1		
J5	Connector, Receptacle	02660	M39012
J6	Same as J1		
J7	Connector, Receptacle, BNC Twinax	02660	M39012
S1	Microswitch, DPDT	09353	8C3011A
XJ7	Bracket	02660	21-000274868



Table 6.2. Parts List (Continued)

REF SYM	NAME AND DESCRIPTION	MFR OR SOURCE	MFR's DATA
1A9	J-3353/FPN-60 Interface Unit		
J1	CONNECTOR, Receptacle, Twinax	02660	UG-422/U
J2	Same as J1		
J3	Same as J1		
J4	Same as J1		
J5	Same as J1		
J6	CONNECTOR, Receptacle, BNC	02660	UG-1094/U
J7	Same as J6		
J8	Same as J1		
J9	Same as J1		
J10	Same as J1		
J11	Same as J1		
J12	Same as J1		
J13	Same as J6		
J14	Same as J6		
J15	CONNECTOR, Receptacle, Panel	02660	26-4401-24P
J16	Same as J15		
J17	Same as J15		
J18	Same as J15		
J19	Same as J15		
J20	CONNECTOR, Receptacle, Panel	02660	26-4401-24S
J21	Same as J15		
J22	Same as J15		
J23	CONNECTOR, Receptacle, Box Mounting	71468	MS3102A22-14S
J24	CONNECTOR, Receptacle, Box Mounting	71468	MS3122E22-55S
J25	Same as J1		
J26	Same as J1		
J27	Same as J1		
J28	Same as J1		
J29	Same as J1		
J30	Same as J1		
J31	Same as J1		
J32	Same as J6		
J33	Same as J1		
J34	Same as J6		
J35	Same as J1		
J36	Same as J1		
J37	Same as J1		
J38	Same as J1		
R1	RESISTOR, 51 , 1/4W, 5%	01121	RC07GF510J
R2	Same as R1		
R3	Same as R1		
R4	Same as R1		
R5	Same as R1		
R6	Same as R1		
R7	Same as R1		
R8	Same as R1		
R9	Same as R1		
R10	Same as R1		
R11	RESISTOR, 680 , 1/4W, 5%	01121	RC07GF681J
R12	Same as R11		

Table 6.2. Parts List (Continued)

REF SYM	NAME AND DESCRIPTION	MFR OR SOURCE	MFR's DATA
R13	RESISTOR, 180 , 1/4W, 5%	01121	RC07GF181J
R14	Same as R13		
R15	Same as R11		
R16	Same as R11		
R17	Same as R11		
R18	RESISTOR, 75 , 1/4W, 5%	01121	RC07GF750J
R19	Same as R13		
R20	Same as R11		
R21	Same as R11		
R22	Same as R11		
R23	Same as R18		
R24	Same as R1		
R25	Same as R1		
R26	Same as R1		
R27	Same as R1		
R28	Same as R13		
R29	Same as R13		
R30	Same as R13		
R31	Same as R13		
R32	Same as R13		
R33	Same as R13		
R34	Same as R11		
R35	Same as R11		
R36	Same as R13		
R37	Same as R11		
R38	Same as R11		
R39	Same as R11		
R40	Same as R18		
R41	Same as R13		
R42	Same as R11		
R43	Same as R11		
R44	Same as R11		
R45	Same as R18		
R46	Same as R11		
R47	Same as R11		
T1	POWER DIVIDER COMBINER	32252	R-HJ-702
T2	Same as T1		
T3	Same as T1		
T4	Same as T1		
T5	Same as T1		
T6	Same as T1		
T7	TRANSFORMER	98330	MB812
T8	Same as T7		
TB1	TERMINAL BOARD	75382	601-18
TB2	Same as TB1		
TB3	TERMINAL BOARD	91833	15514
TB4	Same as TB3		
XT1	SOCKET	05574	VB8-10A49-3
XT2	Same as XT1		
XT3	Same as XT1		
XT4	Same as XT1		

Table 6.2. Parts List
(ROS Modification)

Ref Symbol	Name and Description	Mfr or Source	Mfr's Data
<u>1A9</u>	<u>J-3353/FPN-60A(V)</u> <u>Interface Unit</u>		
K1	Relay, 4PDT, 120VAC	77342	KHS-17A11-120
K2	Same as K1		
K3	Relay, 4PDT, 12VDC	77342	KHS-17D11-12
XK1	Socket, Relay	02660	77M1P20
XK2	Same as XK1		
XK3	Same as XK1		



Table 6.2. Parts List (Continued)

REF SYM	NAME AND DESCRIPTION	MFR OR SOURCE	MFR's DATA
XT5	Same as XT1		
XT6	Same as XT1		
<u>1A10</u>	<u>EPA Junction Box</u>		
J1	CONNECTOR, Receptacle, Panel	02660	26-4401-24S
R1	RESISTOR, 51 , 1/4W, 5%	01121	RC07GF510J
<u>1A11</u>	<u>TCC Junction Box</u>		
J1	CONNECTOR, Receptacle, Panel	02660	26-4401-24P
R1	RESISTOR, 51 , 1/4W, 5%	01121	RC07GF510J

Table 6.3. Table of Manufacturers

00779	AMP, INC. P.O. Box 3608 Harrisburg, PA 17105
01121	Allen-Bradley Co. 1201 S. 2nd St. Milwaukee, WI 53204
02660	Bunker Ramo Corp. Amphenol Connector Div. 2801 S. 25th Ave. Broadview, IL 60153
04009	Crouse-Hinds Arrow Hart, Inc. Arrow Hart Div. 103 Hawthorne St. Hartford, CT 06105
05574	Viking Connectors, Inc. 21001 Nordhoff St. Chatsworth, CA 91311
06124	Mallory Timers Co. Div. of Mallory PR & Co., Inc. 3029 E. Washington St. Indianapolis, IN 46206
07126	The Digitran Co. 855 S. Arroyo Parkway Pasadena, CA 91105
09353	C and K Components, Inc. 103 Morse St. Watertown, MA 02172
12697	Clarostat Mfg. Co., Inc. Lower Washington St. Dover, NH 03820
15238	ITT Semiconductors 500 Broadway Lawrence, MA 01841
23880	Stanford Applied Eng., Inc. 340 Martin Ave. Santa Clara, CA 95050
24429	Powertec, Inc. 9168 Desoto Ave. Chatsworth, CA 91311

Table 6.3. Table of Manufacturers (Continued)

31814	Analogic Corp. Audubon Rd. Wakefield, MA 01880
32252	Olektron, Inc. 6 Chase Ave. Dudley, MA 01570
32997	Bourns Inc. Trimpot Products Div. 1200 Columbia Ave. Riverside, CA 92507
50522	Monsanto Co. Electronic Special Products 3400 Millview Ave. Palo Alto, CA 94303
50721	Datel Systems, Inc. 11 Cabot Blvd. Canton, MA 02021
70255	Alco Controls Div. Emerson Electric Co. 11911 Adie Rd. P. O. Box 12700 St. Louis, MO 70255
71468	ITT Cannon Electric 666 E. Dyer Rd. Santa Ana, CA 92702
71744	Chicago Miniature/Drake 4433 Ravenswood Ave. Chicago, IL 60640
71785	TRW Cinch Connectors 1501 Morse Ave. Chicago, IL 60007
74156	Par-Metals Products 1260 Atlantic Ave. Brooklyn, NY 11219
75382	Kulka Electric Corp. 633 S. Fulton Ave. Mt. Vernon, NY 10550
75915	Littlefuse, Inc. 800 E. Northwest Highway Des Plaines, IL 60016

Table 6.3. Table of Manufacturers (Continued)

77342	AMF Inc. Potter and Brumfield Div. 200 Richland Creek Dr. Princeton, IN 47670
80114	Sprague Products Co. 481 Marshall St. North Adams, MA 01247
91833	Keystone Electronics Corp. 49 Bleacher St. New York, NY 10012
95238	Continental Connector Corp. 34-62 56th Street Woodside, NY 11377
96182	Master Specialties Co. 1640 Morovia Costa Mesa, CA 92627
98330	Polyphase Instrument Co. E. Fourth St. Bridgeport, PA 19475

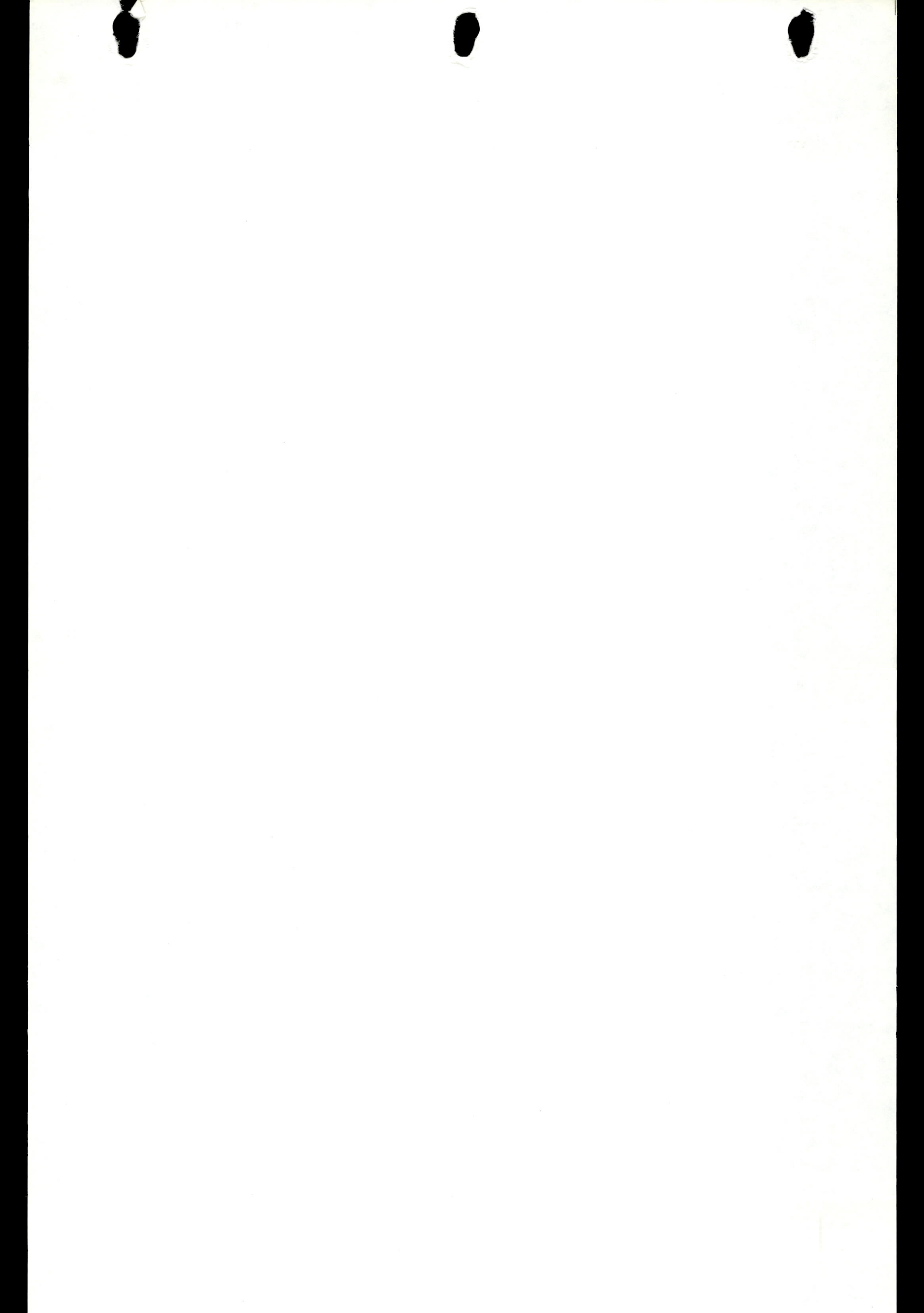
CHAPTER 7

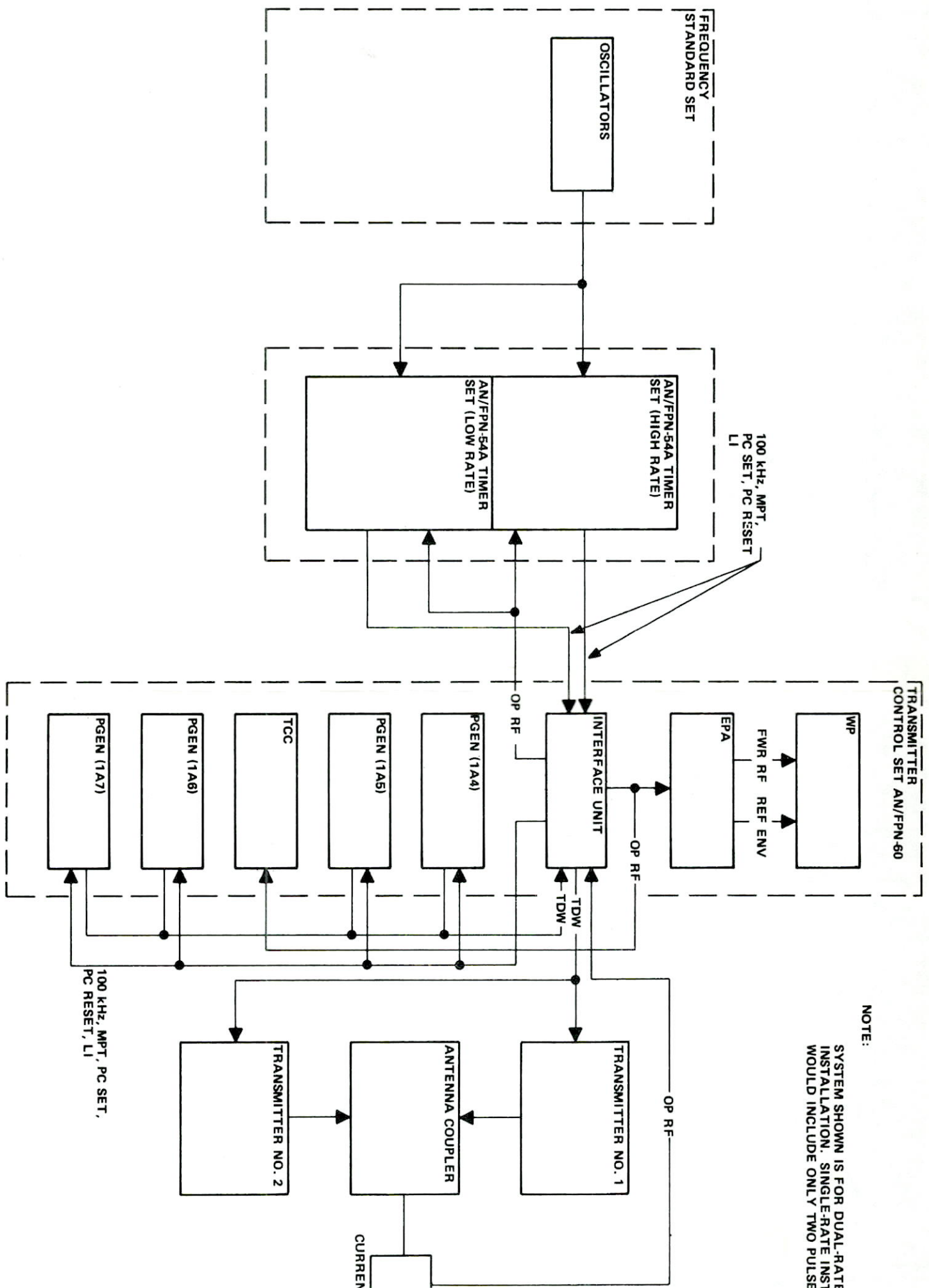
DIAGRAMS AND SCHEMATICS

7.1 Diagrams and Schematics. The following is a list of all diagrams and schematics contained in this chapter:

<u>Figure</u>	<u>Title</u>
7.1	Loran-C System Block Diagram
7.2	Transmitter Control Set Functional Block Text Diagram
7.3	TSC Internal Cable Interconnect Diagram
7.4	Cable Interconnect Diagram Between TCS and Other Units
7.5	Transmitter/TCC System Control Logic Flow Diagram Connected to AN/FPN-39/TCC System Status Wiring Diagram
7.6	Transmitter/TCC System Control Logic Flow Diagram Connected to AN/FPN-39/TCC System Control Wiring Diagram
7.7	Interconnect Diagram for Transmitter Control Set LRE/AN/FPN-39 for Automatic Remote Control
7.7A	Emergency Stop Switch Interconnection Diagram; ROS Modified
7.8	Transmitter/TCC System Control Logic Flow Diagram Connected to AN/FPN-42/TCC System Status Wiring Diagram
7.9	Transmitter/TCC System Control Logic Flow Diagram Connected to AN/FPN-42/TCC System Control Wiring Diagram
7.10	Interconnect Diagram for Transmitter Control Set LRE/AN/FPN-42 for Automatic Remote Control
7.11	Transmitter/TCC System Control Logic Flow Diagram Connected to AN/FPN-44/TCC System Status Wiring Diagram
7.12	Transmitter/TCC System Control Logic Flow Diagram Connected to AN/FPN-44/TCC System Control Wiring Diagram
7.13	Interconnect Diagram for Transmitter Control Set LRE/AN/FPN-44 for Automatic Remote Control
7.14	Transmitter Coupler Control Functional Block Text Diagram
7.15	Transmitter Coupler Control Wiring Diagram
7.16	W0678-5/XMTR CON Module Schematic

<u>Figure</u>	<u>Title</u>
7.17	W0678-5/XMTR CON Module Parts Locator
7.18	W0678-6/XMTR CON DVR Module Schematic
7.19	W0678-6/XMTR CON DVR Module Parts Locator
7.20	Electrical Pulse Analyzer Functional Block Text Diagram
7.20A	Parts Location
7.21	Electrical Pulse Analyzer Wiring Diagram
7.22	W0678-3A/GATCON Module Schematic
7.23	W0678-3A/GATCON Module Parts Locator
7.24	W0678-18C/ECD Module Schematic
7.25	W0678-18C/ECD Module Parts Locator
7.26	W0678-4/PK DET Module Schematic
7.27	W0678-4/PK DET Module Parts Locator
7.28	W0678-11A/CLP ATTN Module Schematic
7.29	W0678-11A/CLP ATTN Module Parts Locator
7.30	Pulse Generator Functional Block Text Diagram
7.31	Pulse Generator Wiring Diagram
7.32	W0678-1/PSYN Module Schematic
7.33	W0678-1/PSYN Module Parts Locator
7.34	W0678-19B/GR DROOP Module Schematic
7.35	W0678-19B/GR DROOP Module Parts Locator
7.36	W0678-2/PCON Module Schematic
7.37	W0678-2/PCON Module Parts Locator
7.38	Interface Unit Wiring Diagram
7.39	Interface Unit Wiring Diagram; ROS Modified

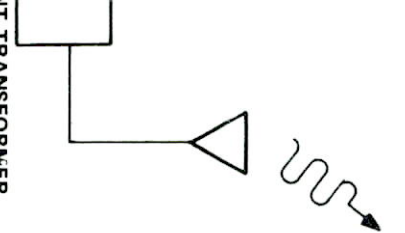




NOTE:
SYSTEM SHOWN IS FOR DUAL-RATE
INSTALLATION. SINGLE-RATE INST
WOULD INCLUDE ONLY TWO PULSE

Figure 7.1. Lorán-C System

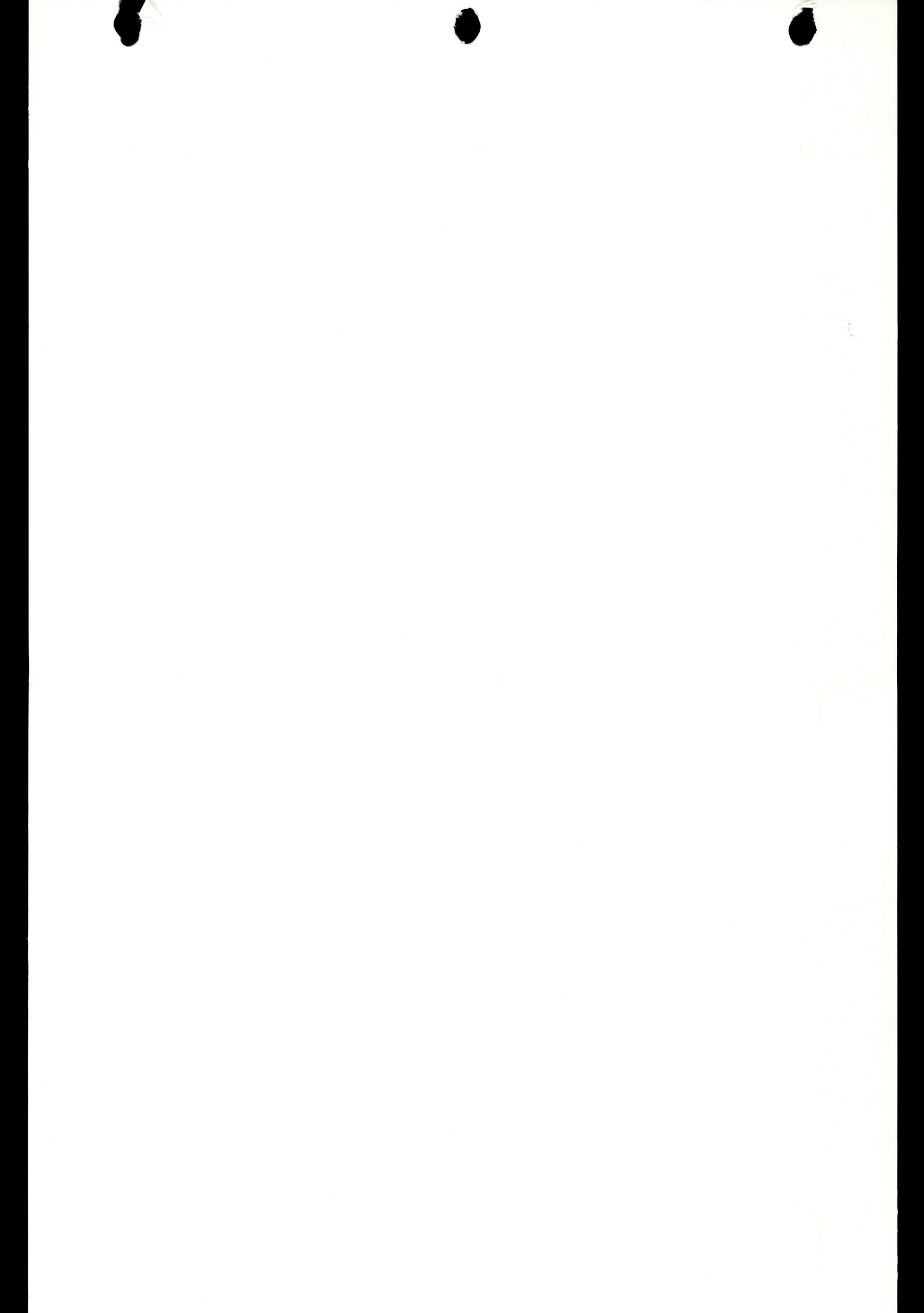
INSTALLATION
GENERATORS.



NT TRANSFORMER

Block Diagram

7.3/7.4



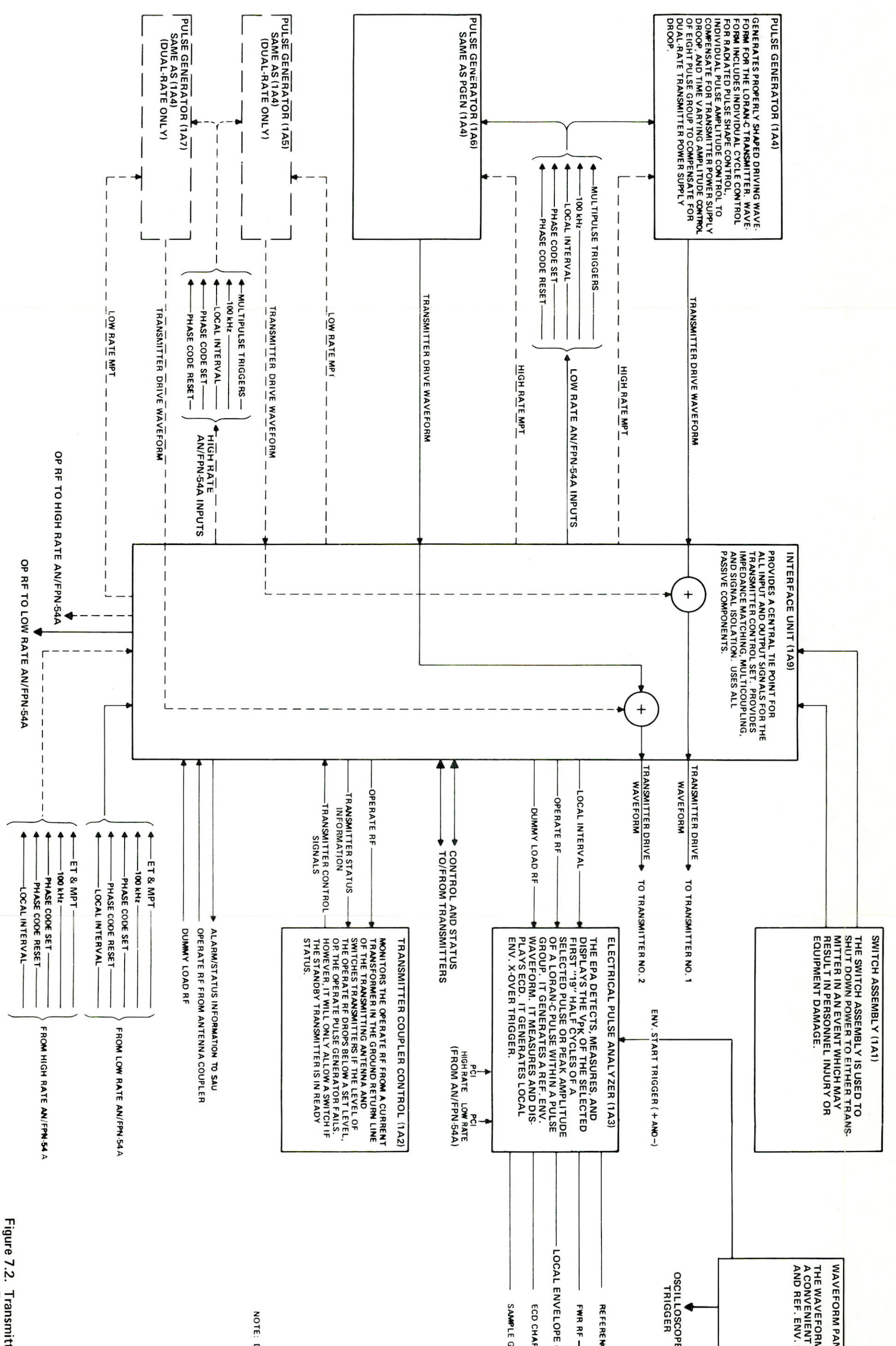
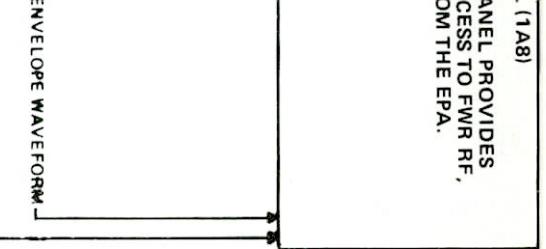


Figure 7.2. Transmitter Functional I

(1A8)

PANEL PROVIDES
ACCESS TO FWR RF,
FROM THE EPA.



ENVELOPE WAVEFORM

CROSSOVER TRIGGER

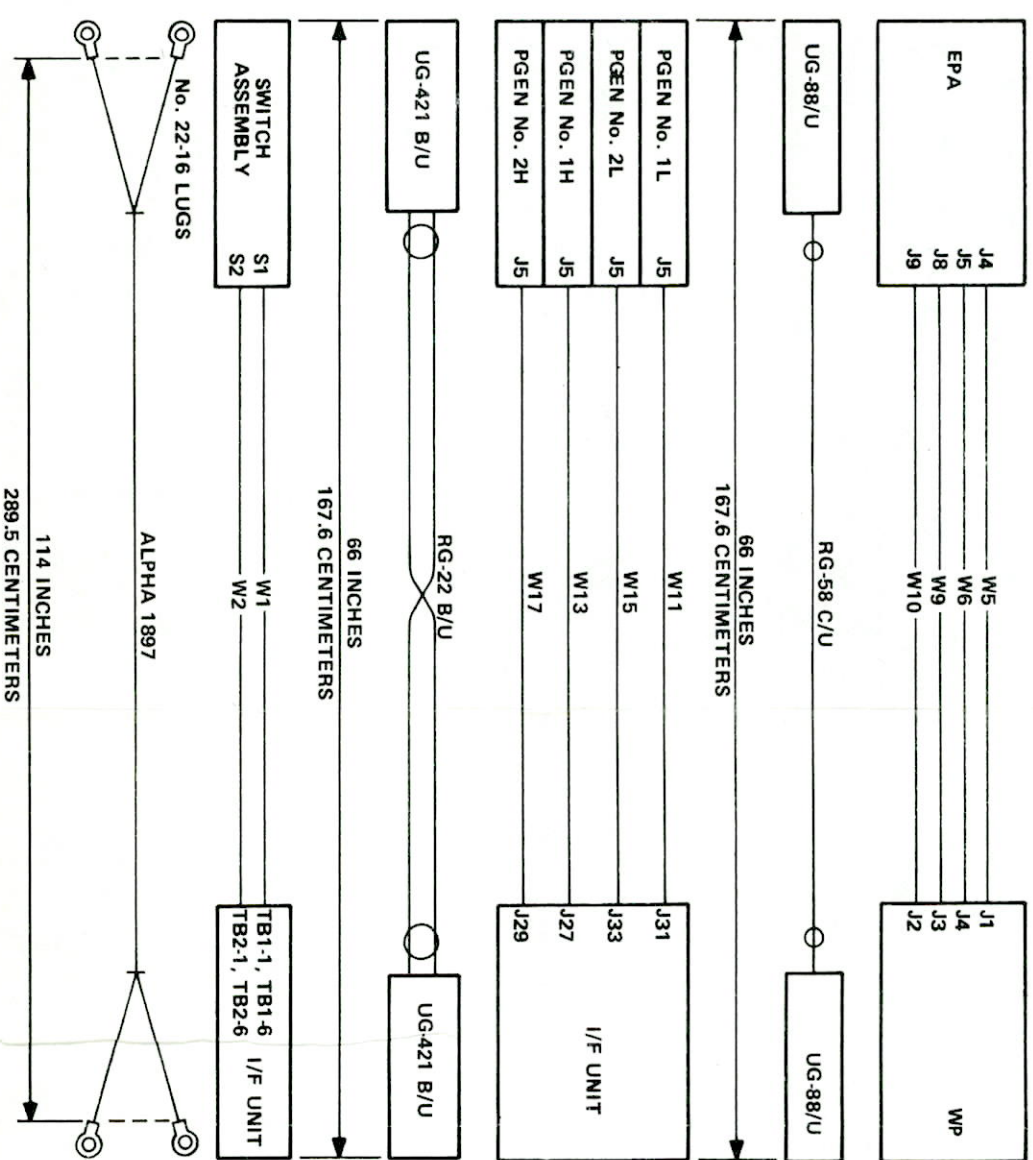
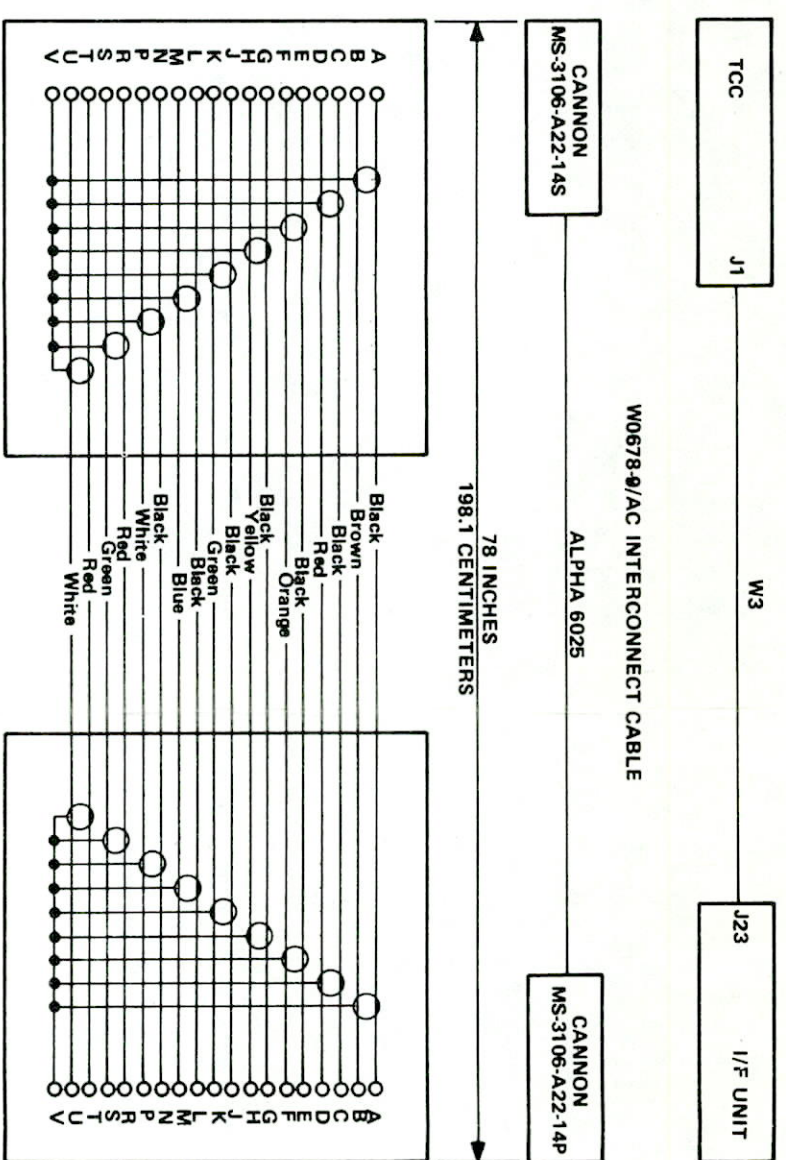
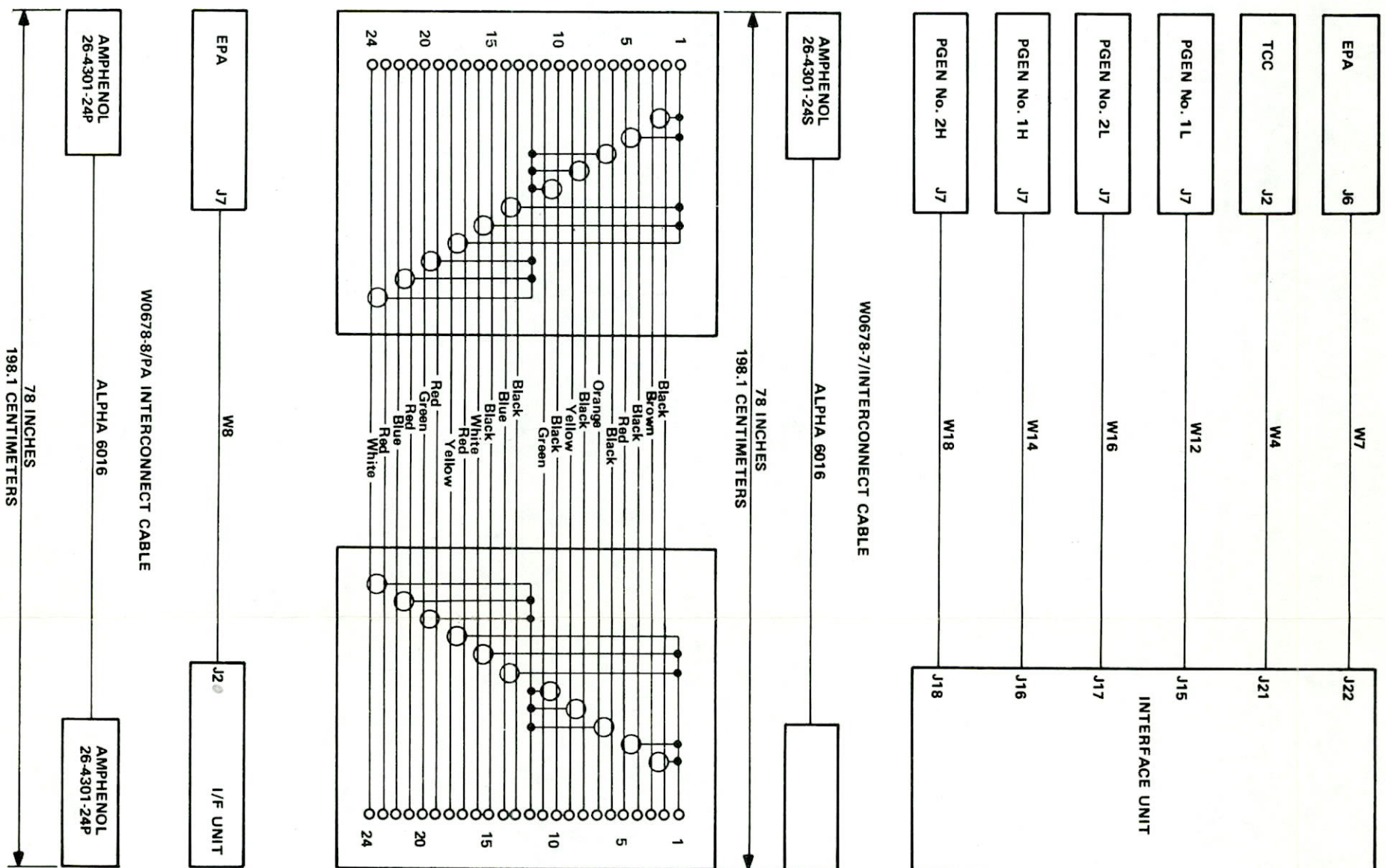
RECORDER

E

TESTED LINES--
NORMAL RATE ONLY

Control Set
Block Text Diagram

7.5/7.6



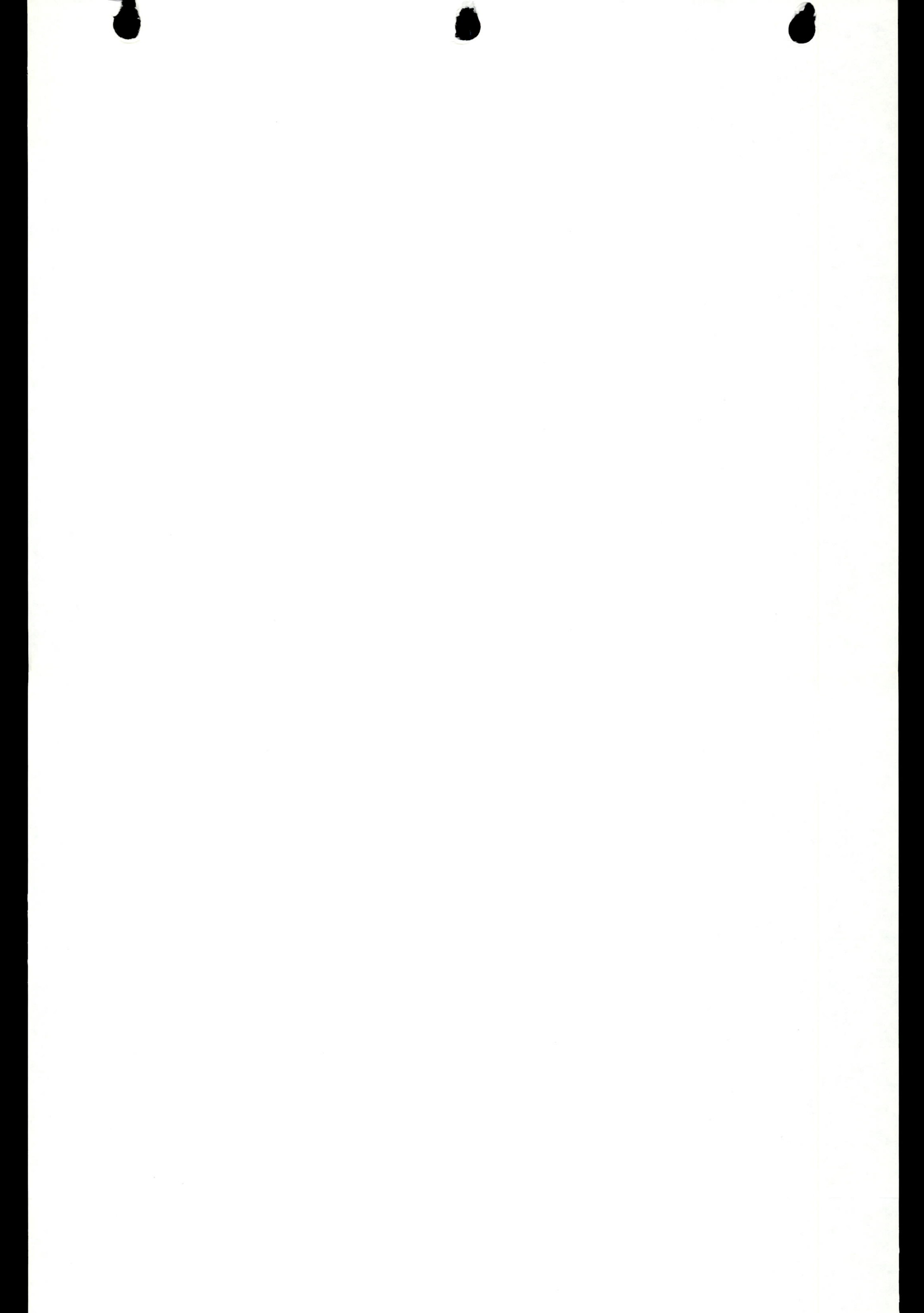
- NOTES:
1. THIS CONFIGURATION STATION, A SINGLE-RS NOT HAVE PGEN'S 1A5 W13, W14, W17, and W18
 2. W11, W13, W15, and W17 SEE PARAGRAPH 2.3.8.

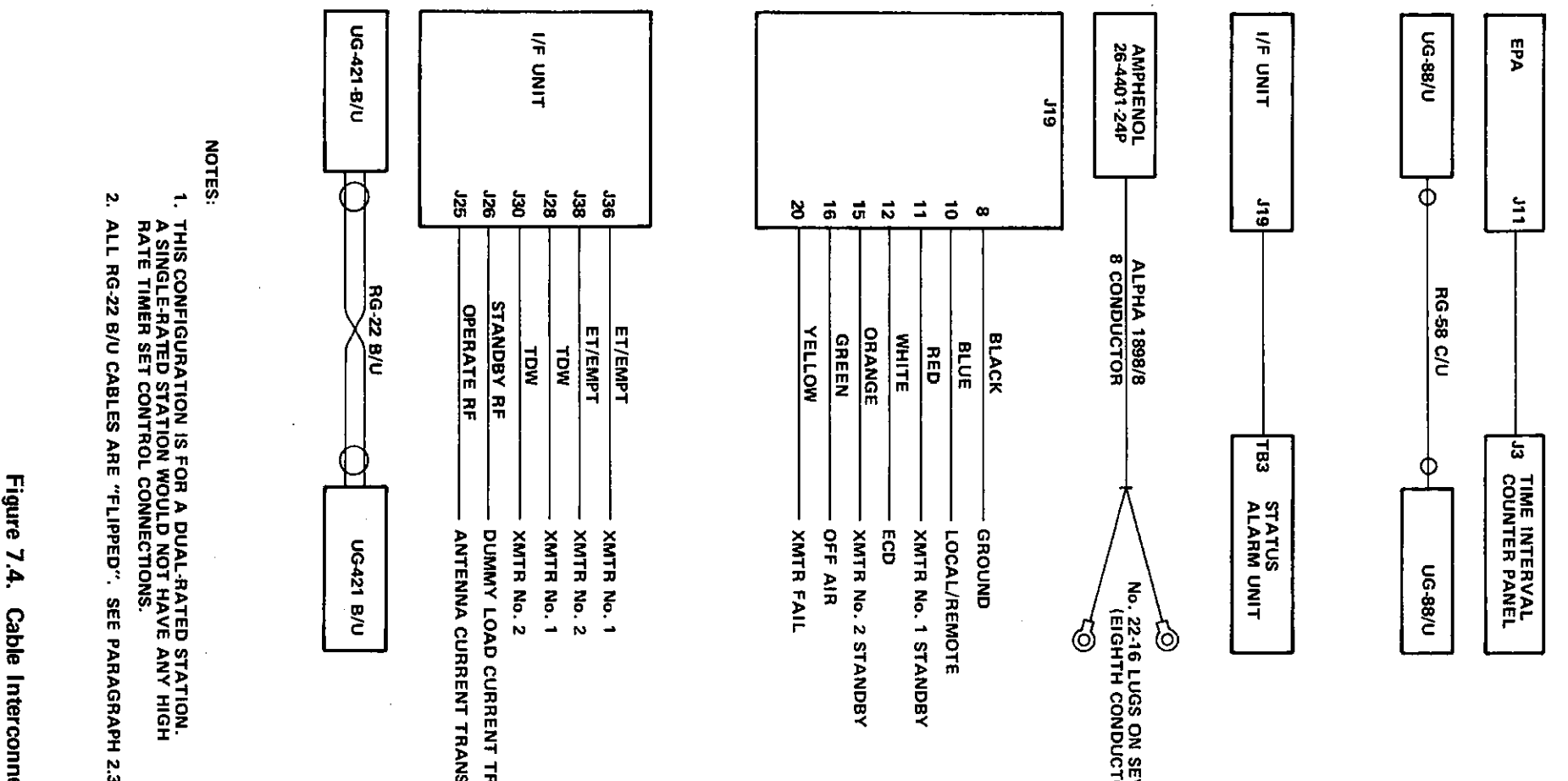
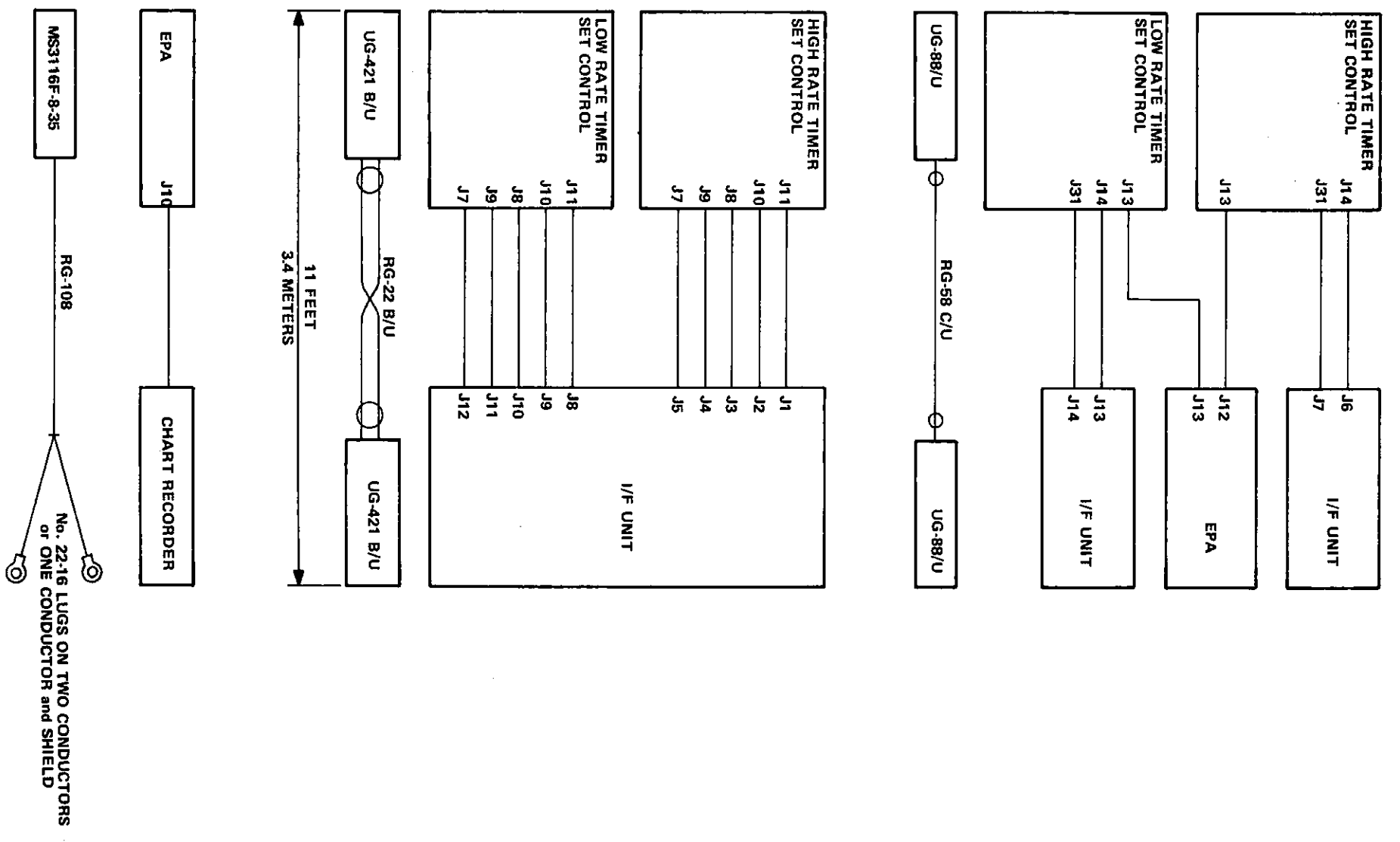
Figure 7.3. TCC Inte

FOR A DUAL-RATED
ATED STATION WOULD
and 1A7, and CABLES
1.
2.
3. ARE "FLIPPED".

S Internal Cable
Interconnect Diagram

7.7/7.8





- NOTES:
1. THIS CONFIGURATION IS FOR A DUAL-RATED STATION. A SINGLE-RATED STATION WOULD NOT HAVE ANY HIGH RATE TIMER SET CONTROL CONNECTIONS.
 2. ALL RG-22 B/U CABLES ARE "FLIPPED". SEE PARAGRAPH 2.3.8

Figure 7.4. Cable Interconnections of TCS and Other U

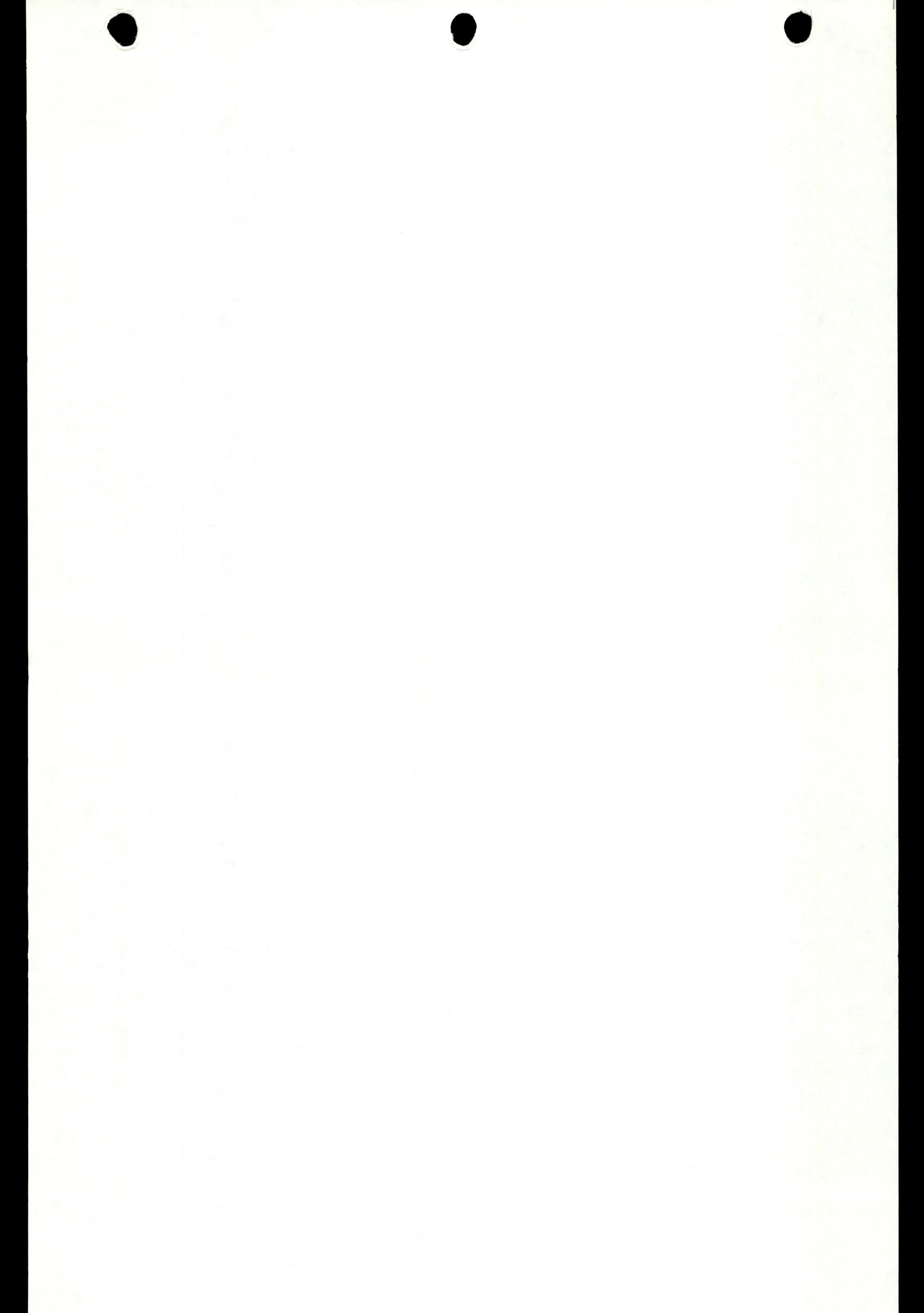
EN CONDUCTORS
R IS A SPARE)

ANSFORMER
ORMER

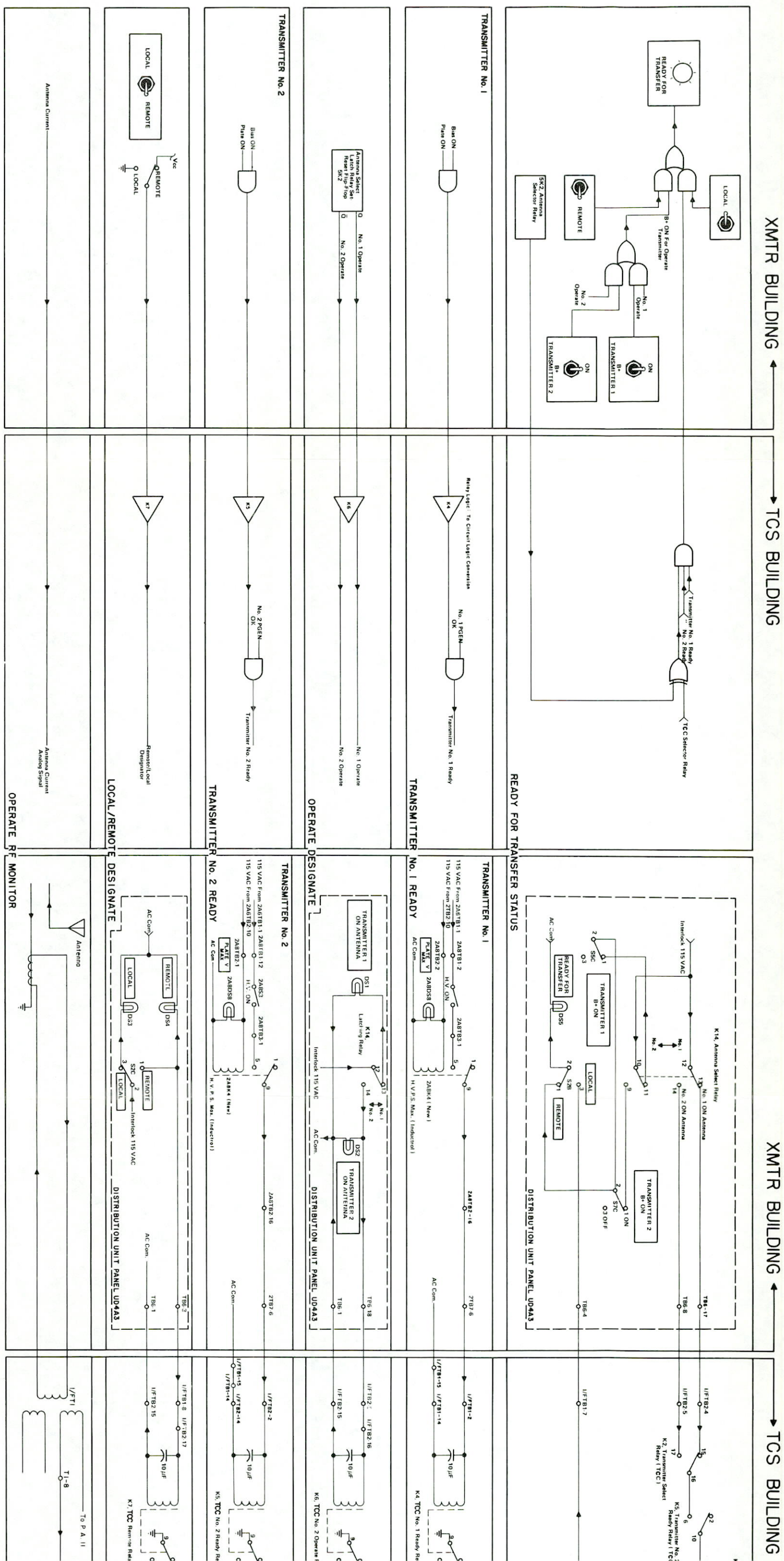
3.3.

st Diagram Between
nits

7.9/7.10

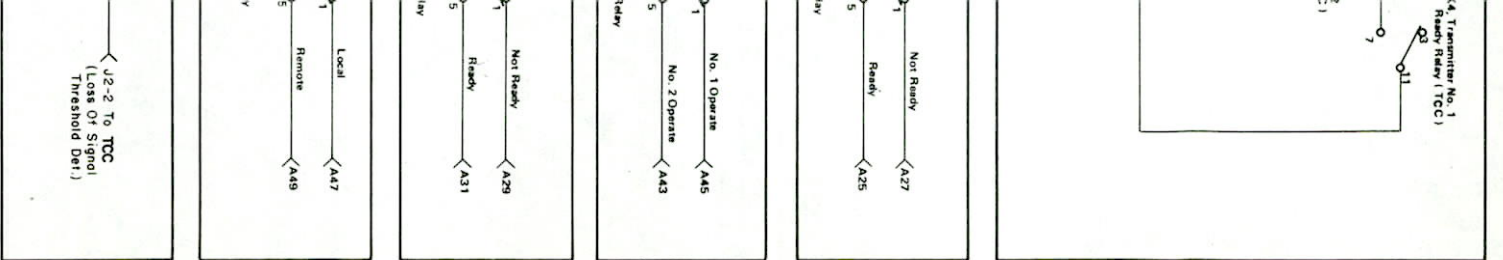


SYSTEM STATUS



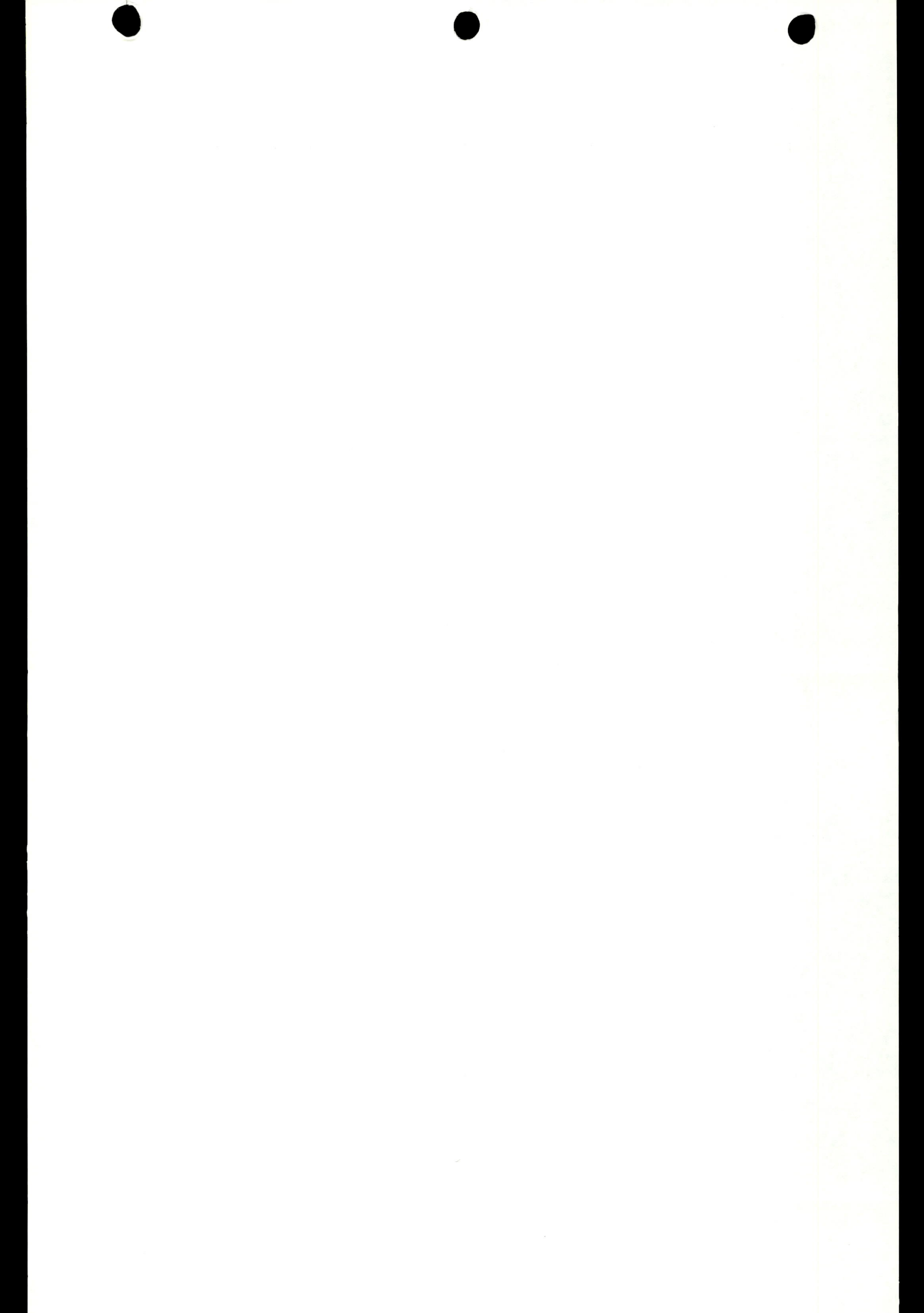
- NOTES:
1. ALL RELAYS SHOWN IN DE-ENERGIZED STATE. (NORMALLY CLOSED POSITION).
 2. LATCHING RELAYS 4A3K14 AND (TCC) K2 ARE IN TRANSMITTER No. 1 OPERATE POSITION.

Figure 7.5. Transmitter/TCC System Control Logic Connected To AN/FPN-39/TCC System

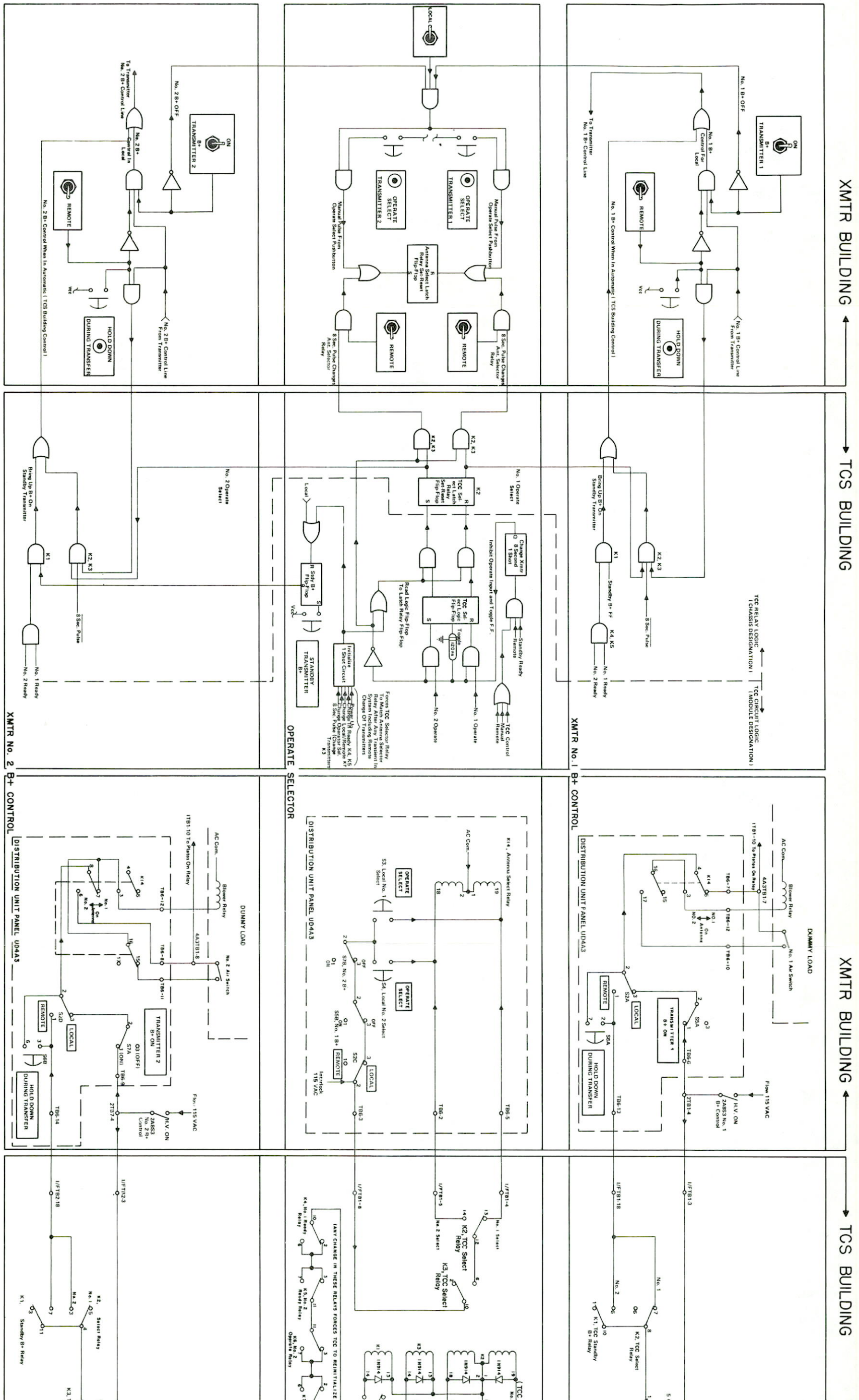


Flow Diagram
 Status Wiring Diagram

7.11/7.12



SYSTEM CONTROL

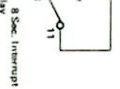
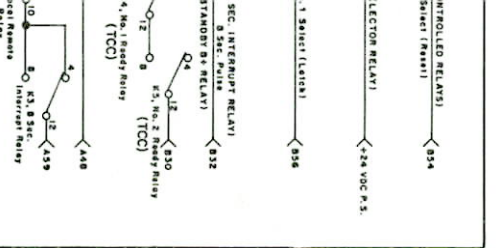
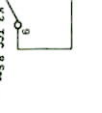


LOGIC DIAGRAM

WIRING DIAGRAM

- NOTES:
1. ALL RELAYS SHOWN IN DE-ENERGIZED STATE. (NORMALLY CLOSED POSITION).
 2. LATCHING RELAYS 4A3K14 AND (TCC) K2 ARE IN TRANSMITTER No. 1 OPERATE POSITION.

Figure 7.6. Transmitter/TCC System Control Logic Connected To AN/FPN-39/TCC System



Flow Diagram
Control Wiring Diagram

7.13/7.14



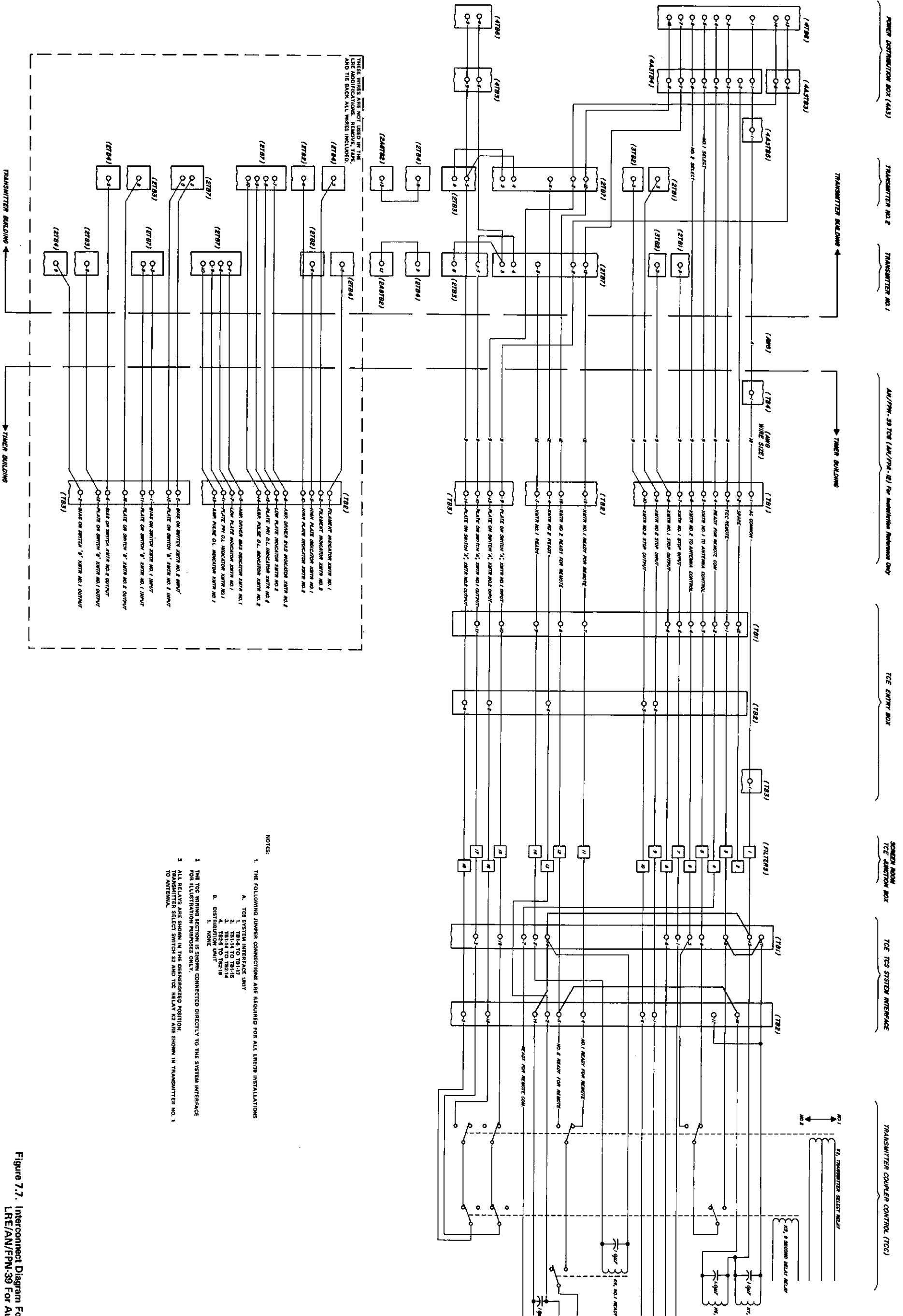
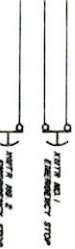


Figure 7.7. Interconnect Diagram For LRE/AN/FPN-39 For AN/FPN-39 TOS (AN/FPN-39) For Antenna Interference Only

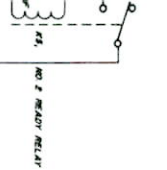
SWITCH ASSEMBLY

REMOTE RELAY

NO 2 OPERATE



RELAY



or Transmitter Control Set
Automatic Remote Control

7.15/7.16

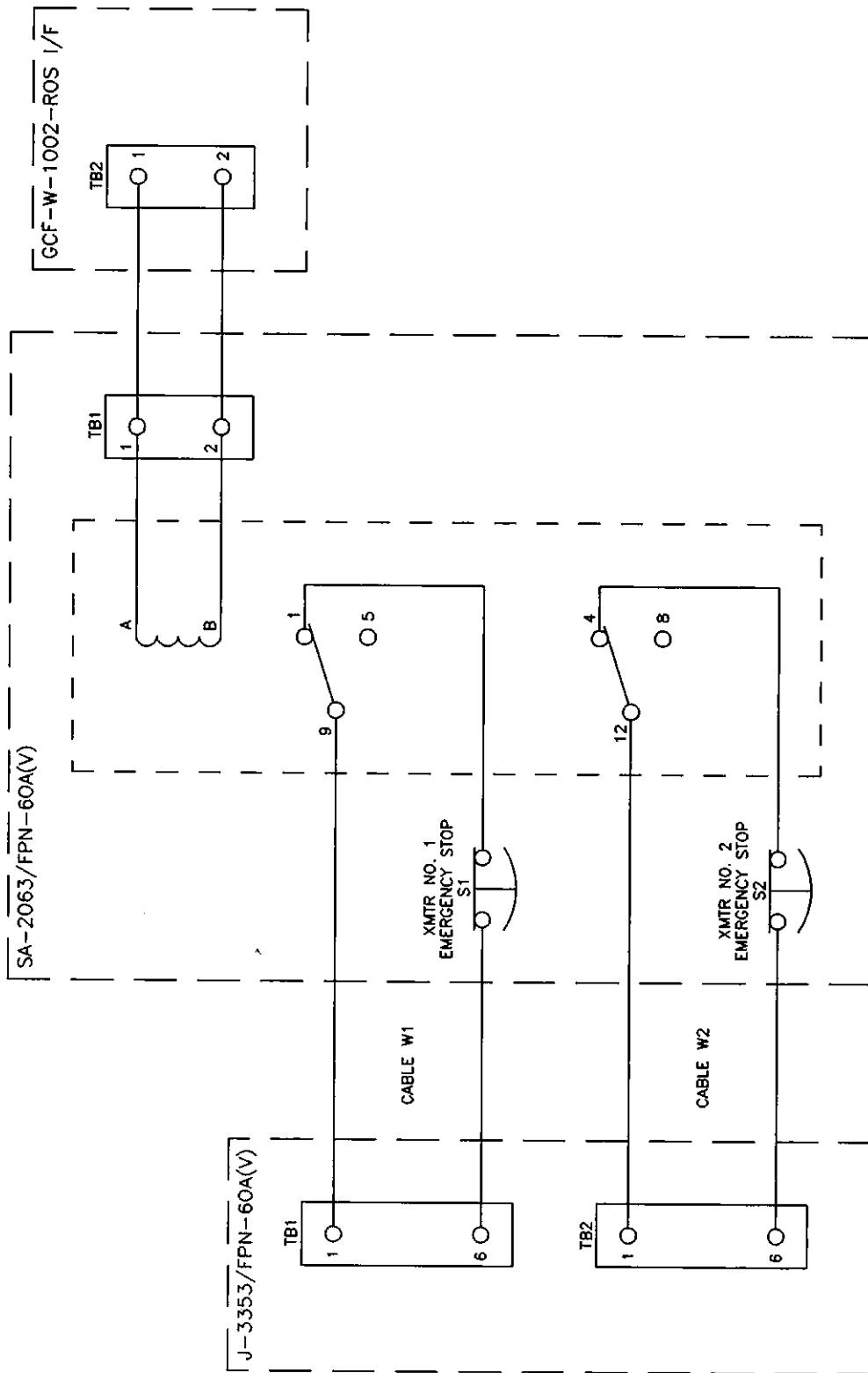
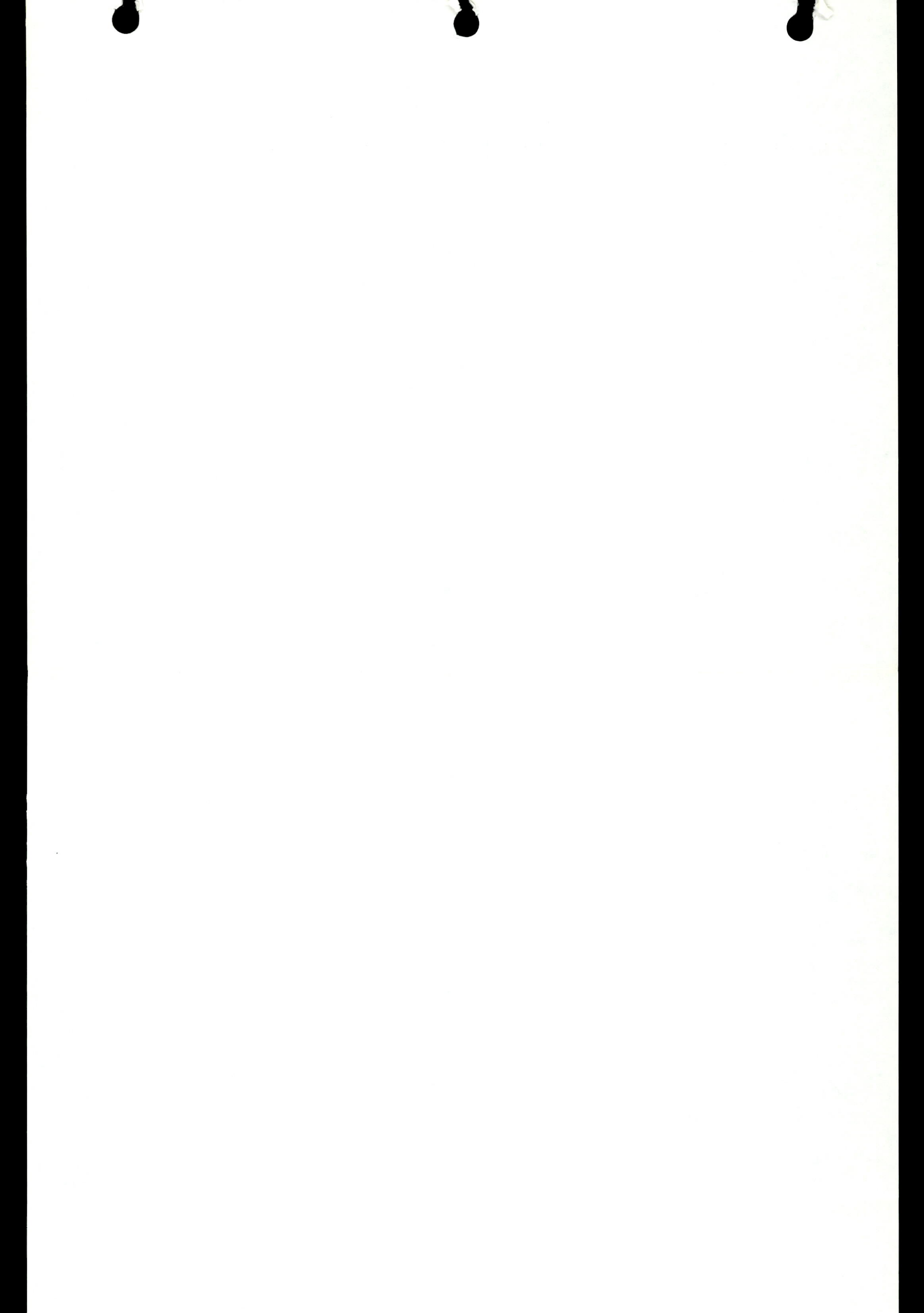
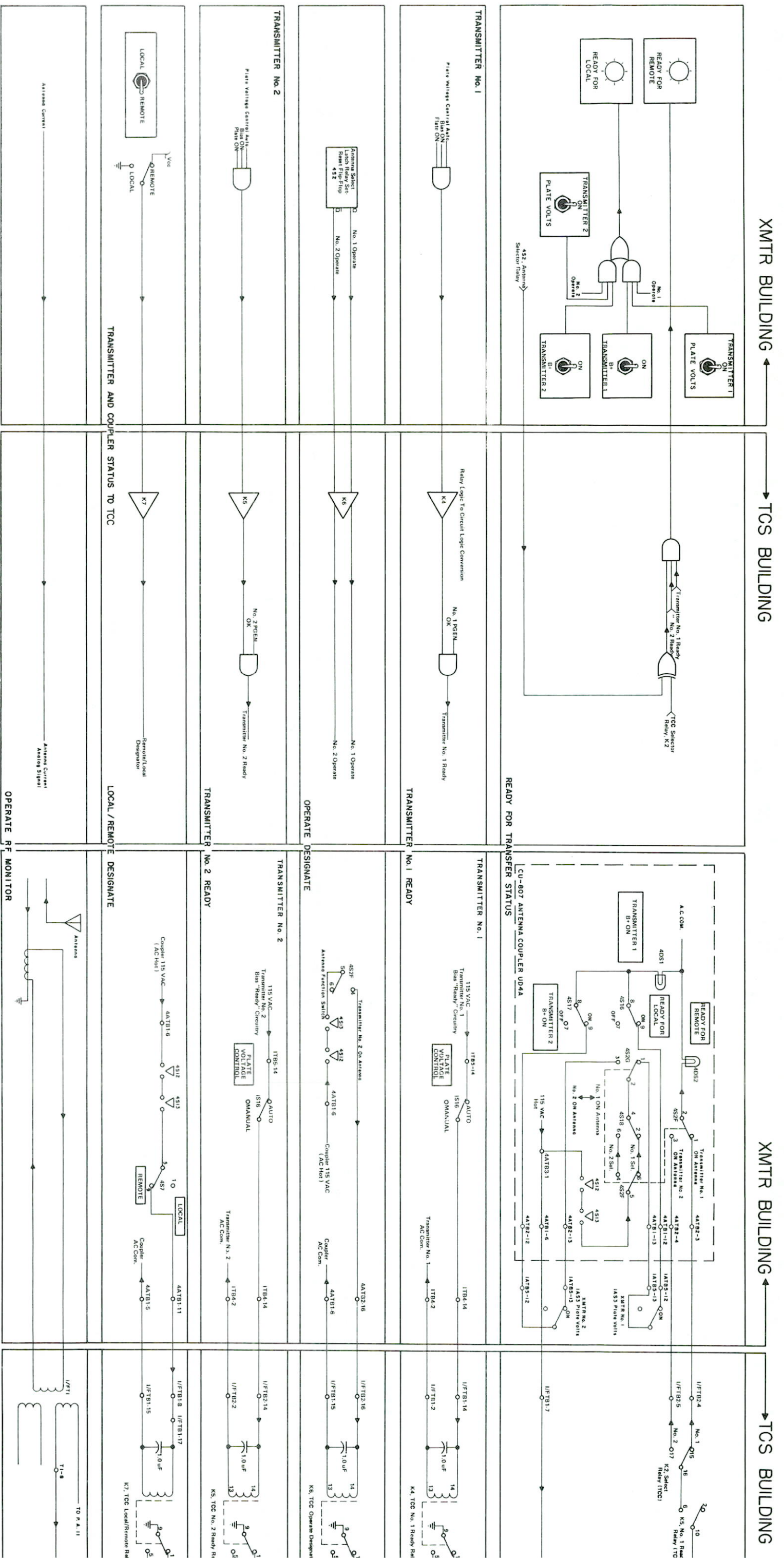


Figure 7.7A. Emergency Stop Switch Interconnection Diagram; ROS Modified





SYSTEM STATUS

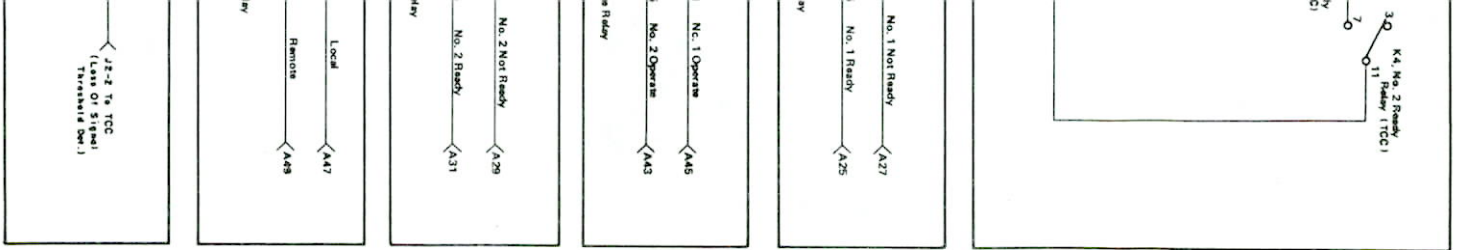


LOGIC DIAGRAM

WIRING DIAGRAM

- NOTES:
1. ALL RELAYS SHOWN IN DE-ENERGIZED STATE. (NORMALLY CLOSED POSITION).
 2. LEDEX SWITCH 452 AND (TCC) K2 ARE IN TRANSMITTER No. 1 OPERATE POSITION.

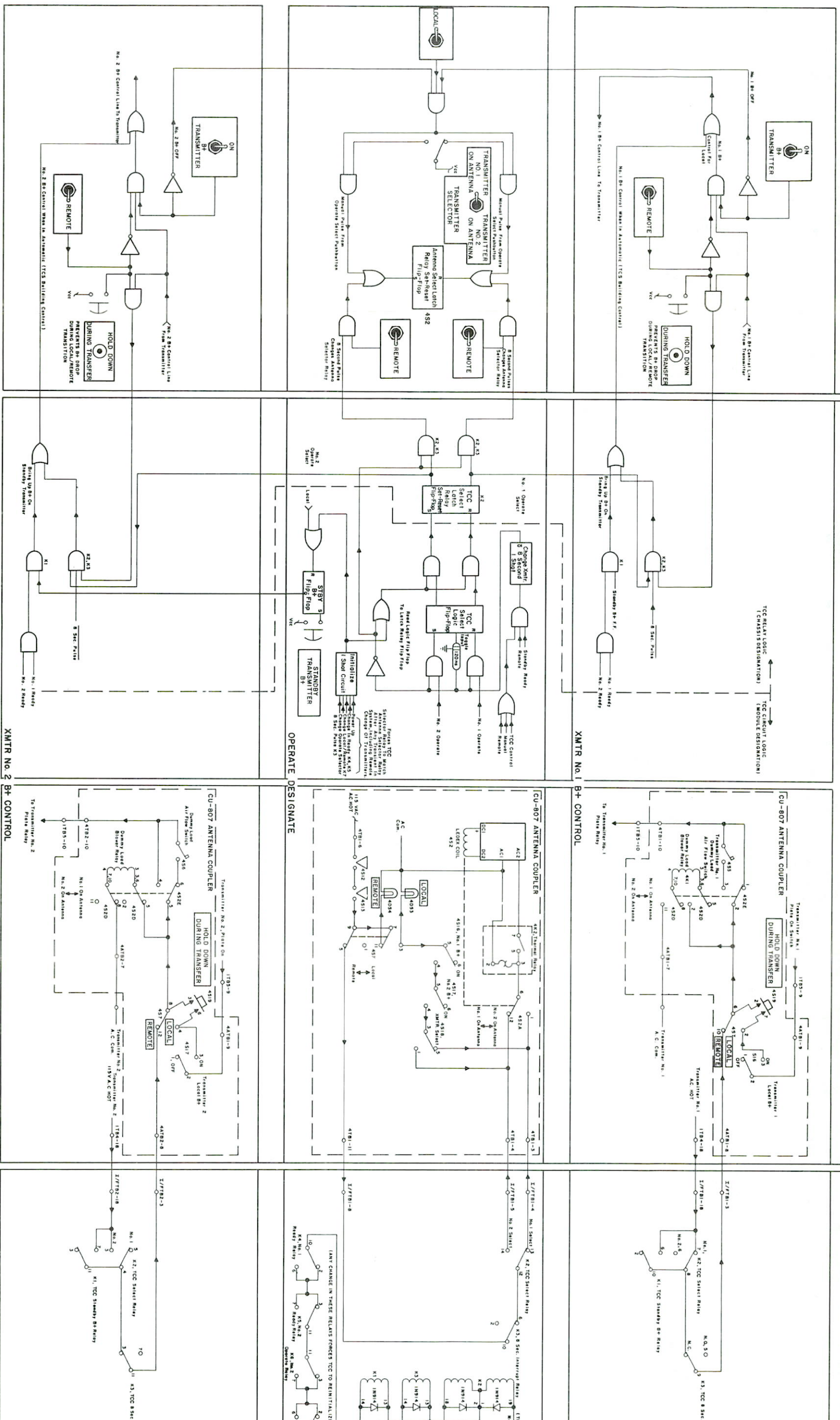
Figure 7.8. Transmitter/TCC System Status Logic F Connected To AN/FPN-42/TCC System



Flow Diagram
Status Wiring Diagram
7.17/7.18



SYSTEM CONTROL

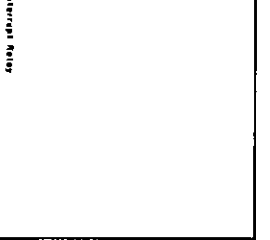
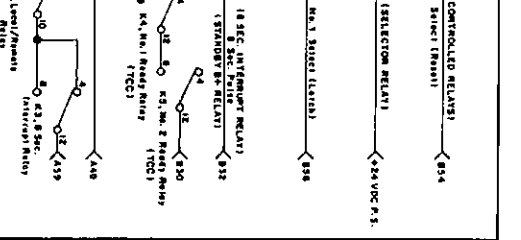
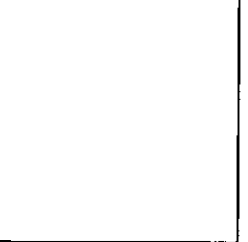


LOGIC DIAGRAM

WIRING DIAGRAM

- NOTES:
1. ALL RELAYS SHOWN IN DE-ENERGIZED STATE. (NORMALLY CLOSED POSITION).
 2. LEDEX SWITCH 4S2 AND (TCC) LATCHING RELAY K2 ARE IN TRANSMITTER NO. 1 OPERATE POSITION.

Figure 7.9. Transmitter/TCC System Control Logic Connected To AN/FPN-42/TCC System



Flow Diagram
 Control Wiring Diagram

7.19/7.20



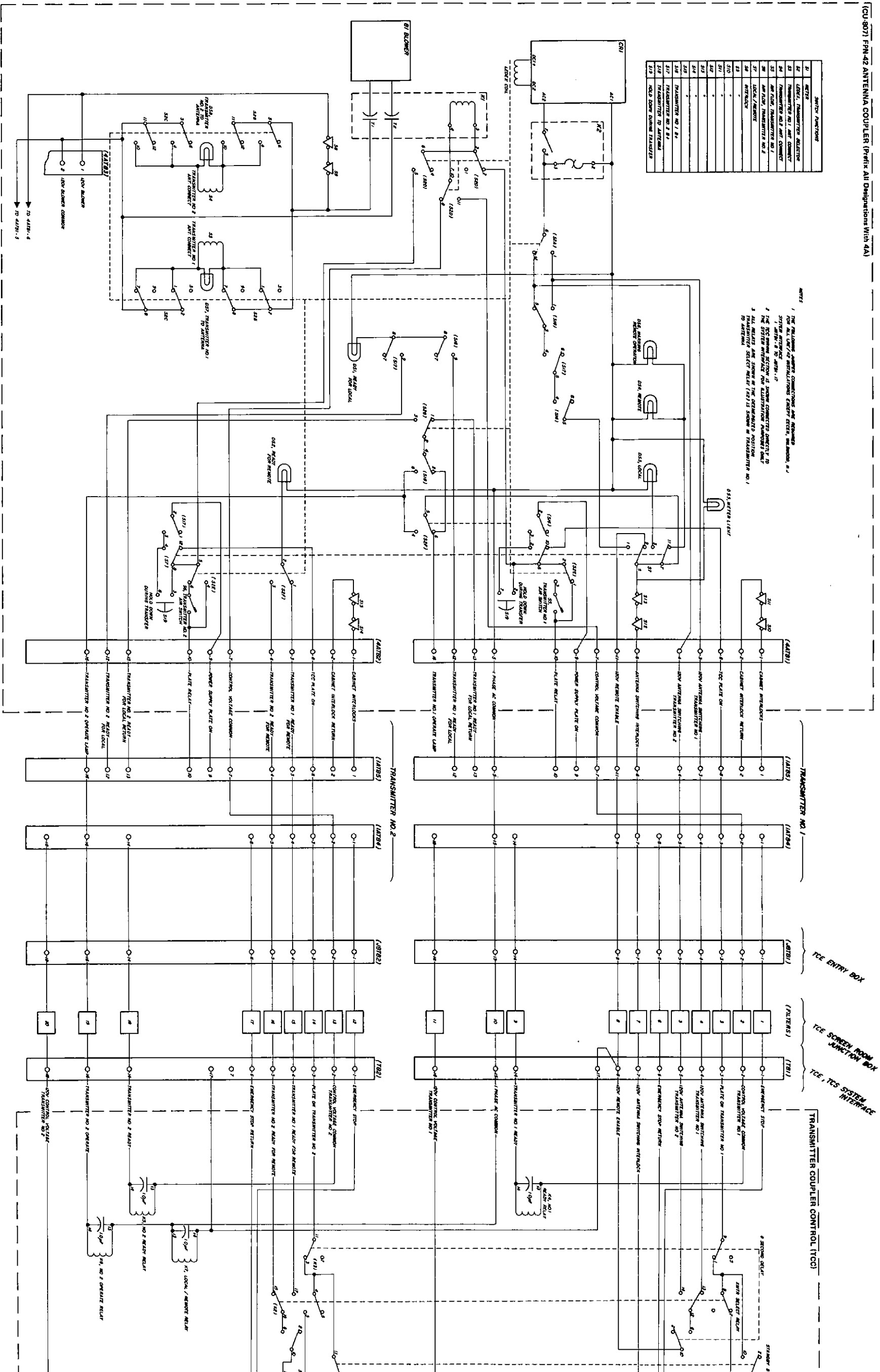
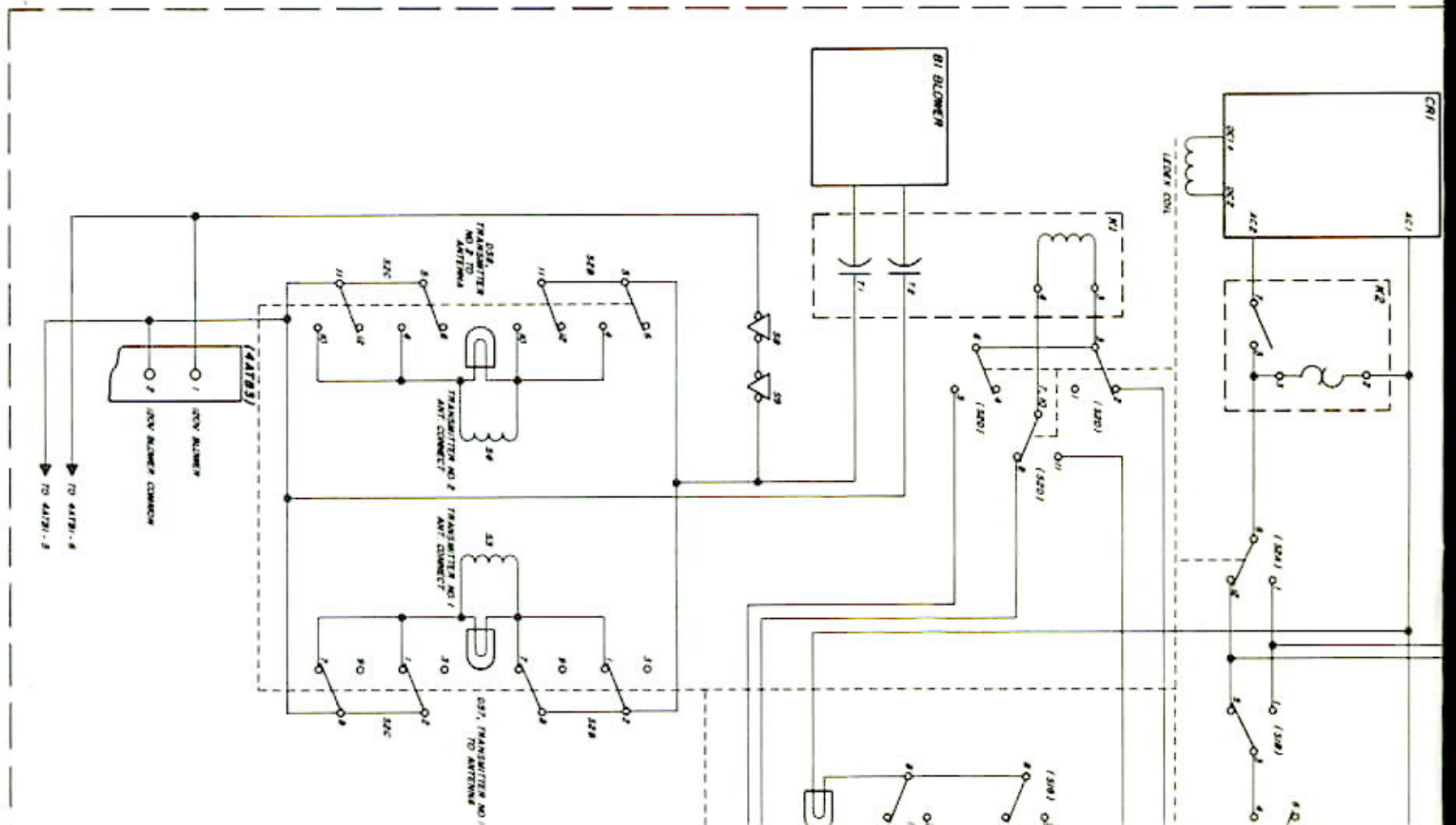


Figure 7.10. Interconnect Diagram For LRE Set For Automatic Remote Co

706



(CU-807) FPN-42 ANTENNA COUPLER (Prefix All Designations With 4A)

SWITCH FUNCTIONS	
51	WTT#
52	LINE 1, TRANSMITTER SELECTOR
53	TRANSMITTER NO. 1 ANT. CONNECT
54	TRANSMITTER NO. 2 ANT. CONNECT
55	ANT. FLOW, TRANSMITTER NO. 1
56	ANT. FLOW, TRANSMITTER NO. 2
57	LINE 1/REVERSE
58	MTZ. LOCK
59	"
510	"
511	"
512	"
513	"
514	"
515	TRANSMITTER NO. 1 B.A.
516	TRANSMITTER NO. 2 B.A.
517	TRANSMITTER TO ANTENNA
518	NO. 2 SW. NUMBER TRANSFER

NOTES
 1 THE FOLLOWING ARE FOR ALL LINE/42
 SYSTEM ANTENNAS
 2 THE REC. PART OF
 3 THE SYSTEM ANTENNA
 4 ALL WELDS ARE TO ANTENNA



018, DRAWING
 NUMBER 000000

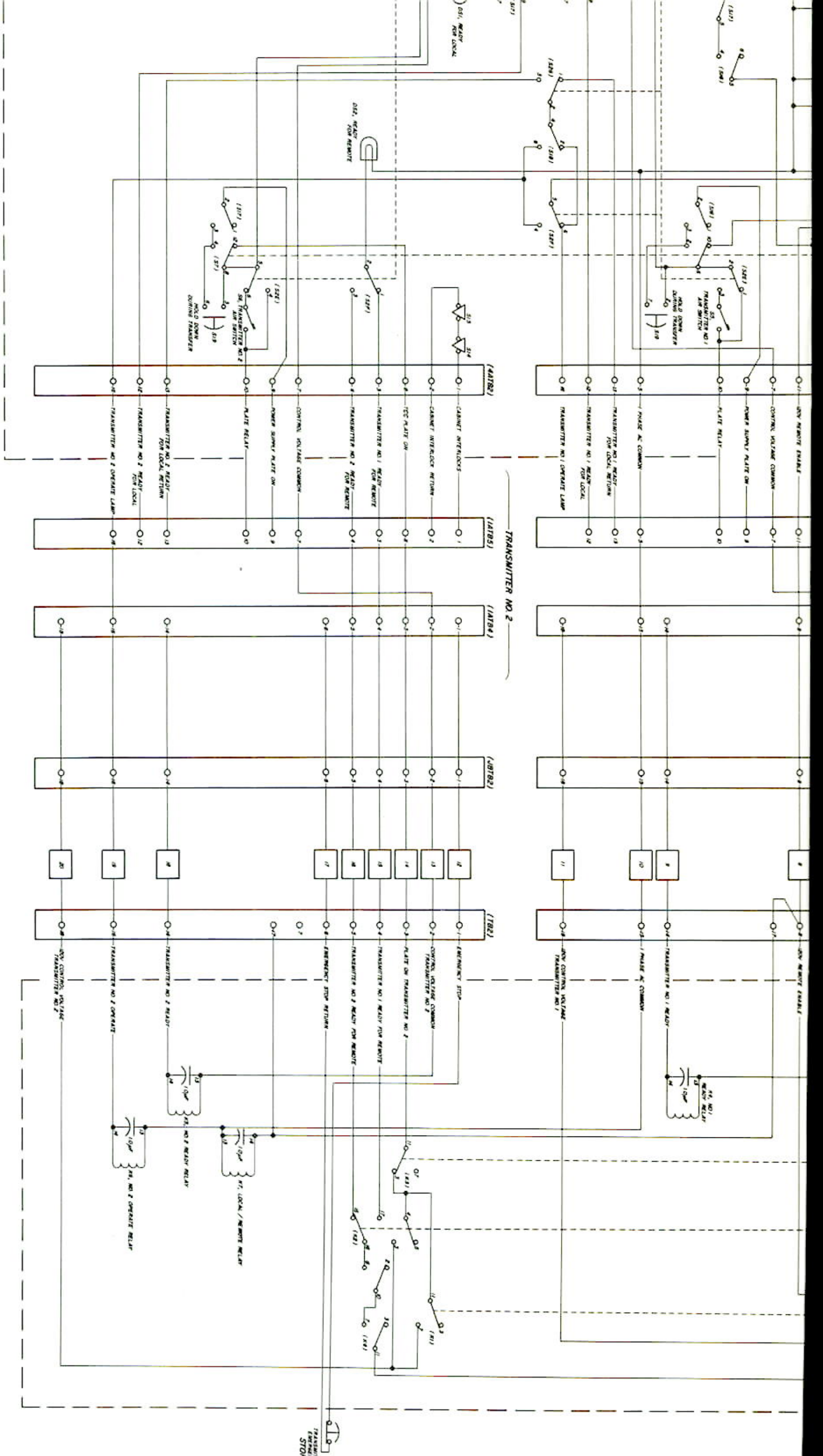


Figure 7.10. Interconnect Diagram For LRE/AN/FPN 42 Transmitter Set For Automatic Remote Control

TELEPHONE
SWITCH

ter

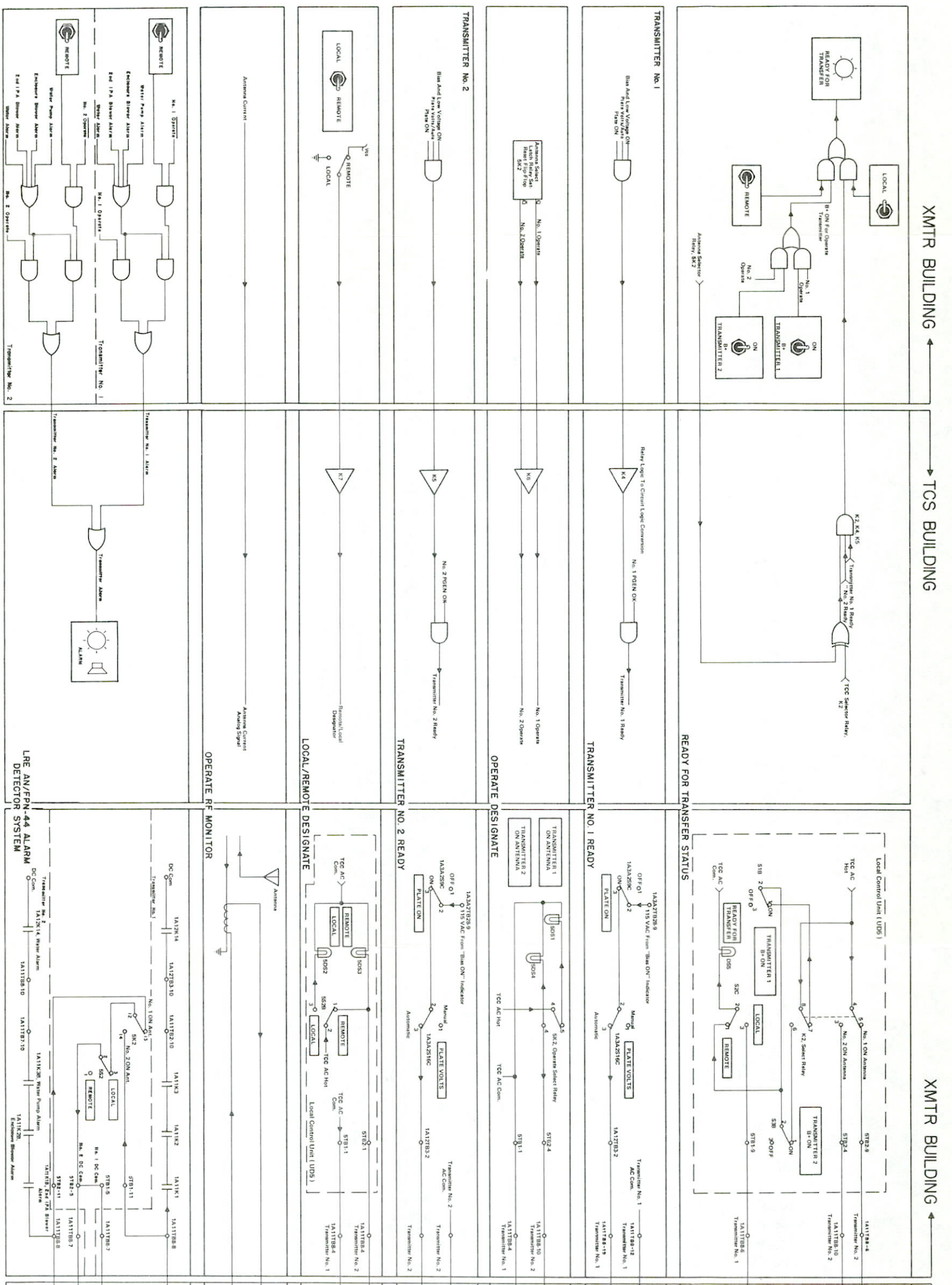
2

1

SWITCH

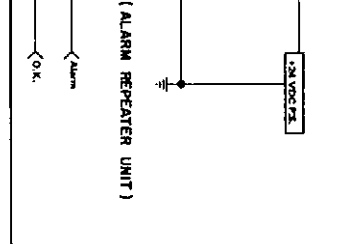
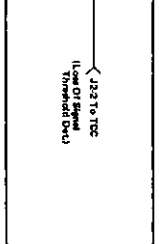
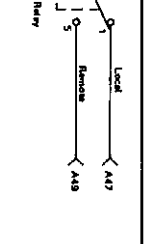
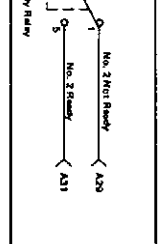
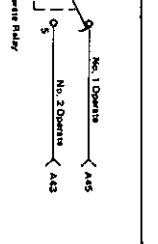
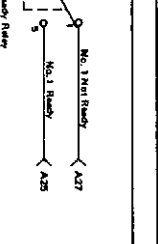
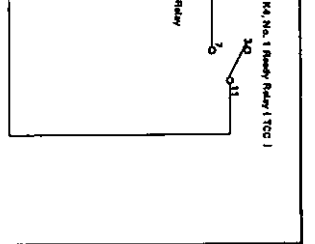


SYSTEM STATUS



- NOTES:
1. ALL RELAYS SHOWN IN DE-ENERGIZED STATE. (NORMALLY CLOSED POSITION).
 2. LATCHING RELAYS SK2 AND (TCC) K2 ARE IN TRANSMITTER NO. 1 POSITION.

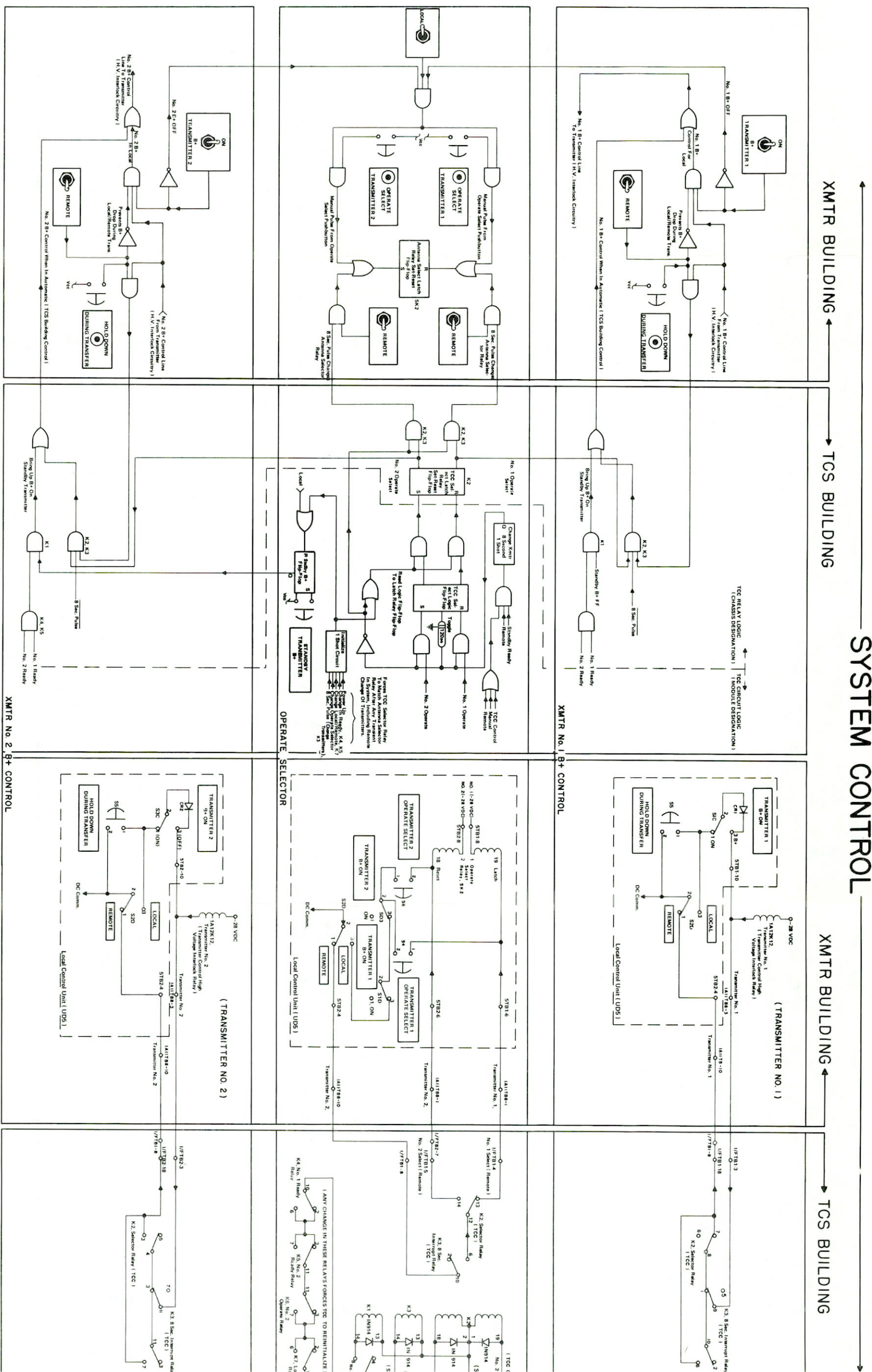
Figure 7.11. Transmitter/TCC System Status Logic Connected To AN/FPN-44/TCC Syst



Logic Flow Diagram
Alarm Status Wiring Diagram
7.23/7.24



SYSTEM CONTROL

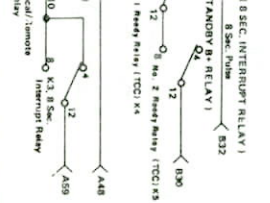
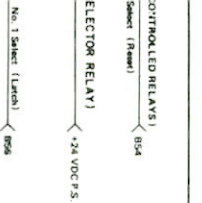


LOGIC DIAGRAM

WIRING DIAGRAM

- NOTES:**
1. ALL RELAYS SHOWN IN DE-ENERGIZED STATE. (NORMALLY CLOSED POSITION).
 2. LATCHING RELAYS SK2 AND (TCC) K2 ARE IN TRANSMITTER No. 1 OPERATE POSITION.

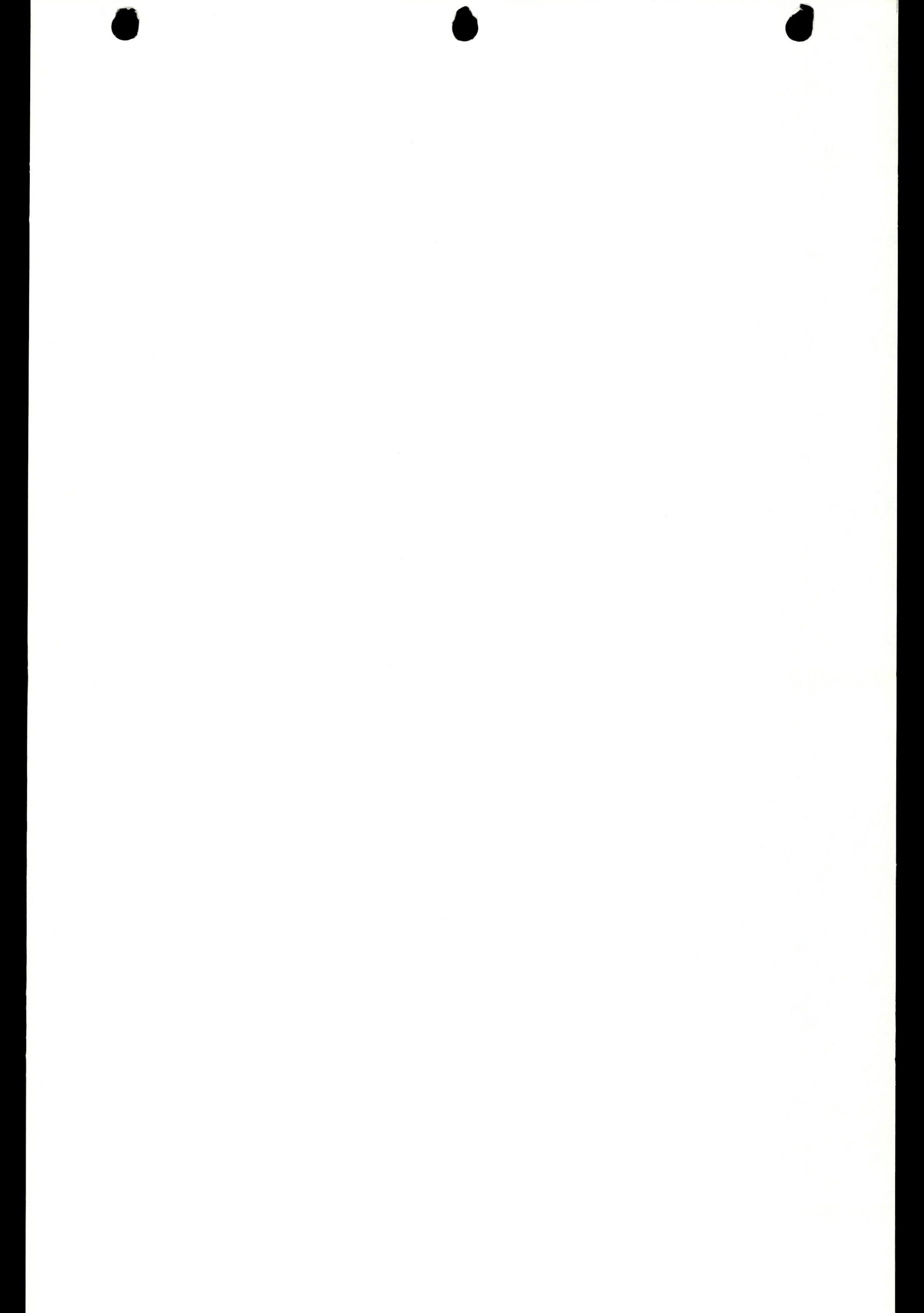
Figure 7.12. Transmitter/TCC System Control Logic Connected To AN/FPN-44/TCC System

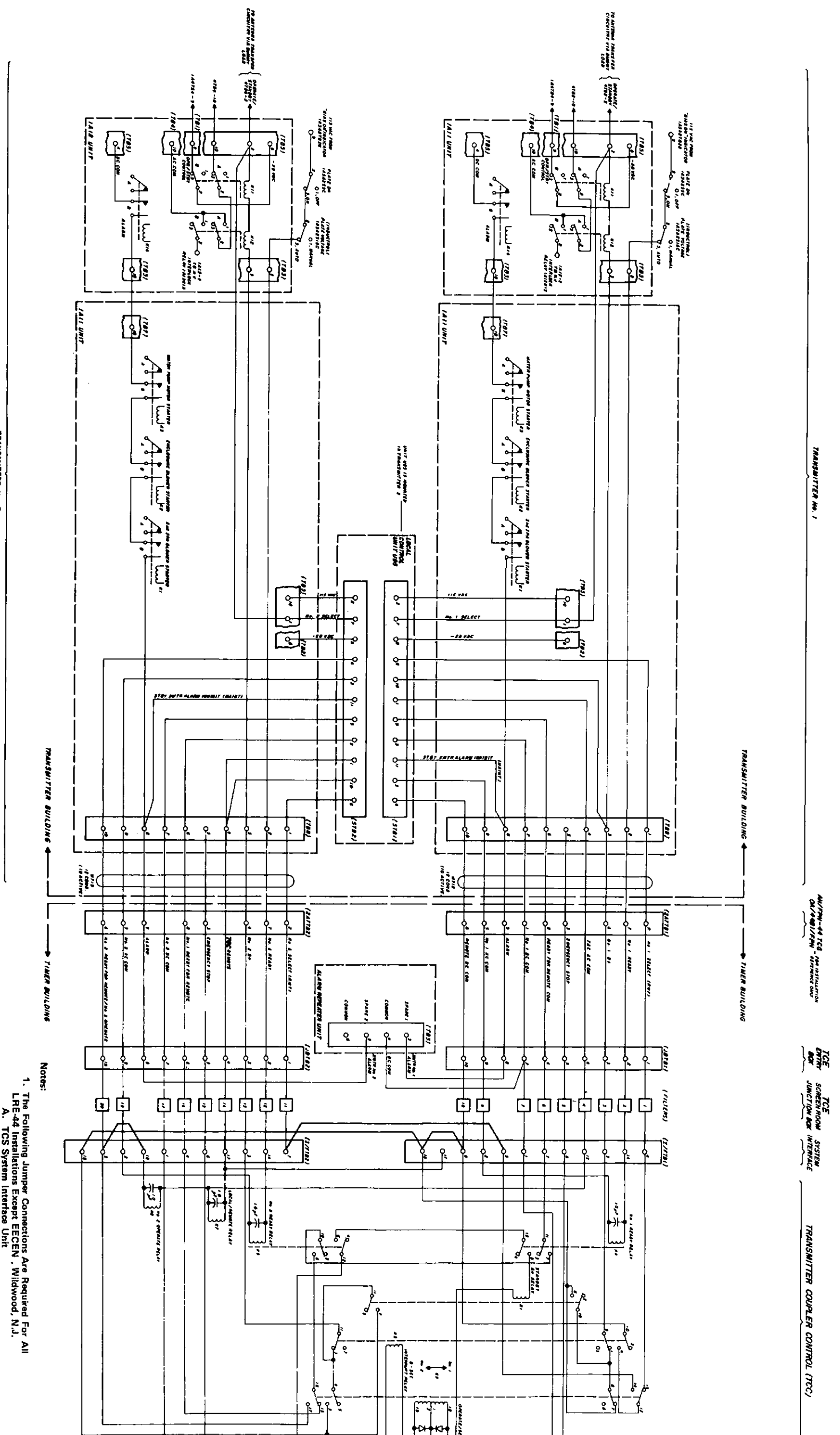


K1, Standby B+ Relay
(TCC)

Flow Diagram
Control Wiring Diagram

7.25/7.26





- Notes:
1. The Following Jumper Connections Are Required For All LRE-44 Installations Except EECEN, Wildwood, N.J.
 - A. TCS System Interface Unit
 1. TB1-8 to TB1-18
 2. TB1-5 to TB2-7
 3. TB1-18 to TB2-18
 4. TB2-16 to TB2-5
 2. The TCC Wiring Section Is Shown Connected Directly To The System Interface For Illustration Purposes Only.
 3. All Relays Shown In De-energized Position. TCC Relay K2 Is Shown In Transmitter 1 Operate.

Figure 7.13. Interconnect Diagram For LRE-44 Transmitter Set For Automa

SWITCH ASSEMBLY



RE/AN/FPN-44
tic Remote Control

7.27/7.28



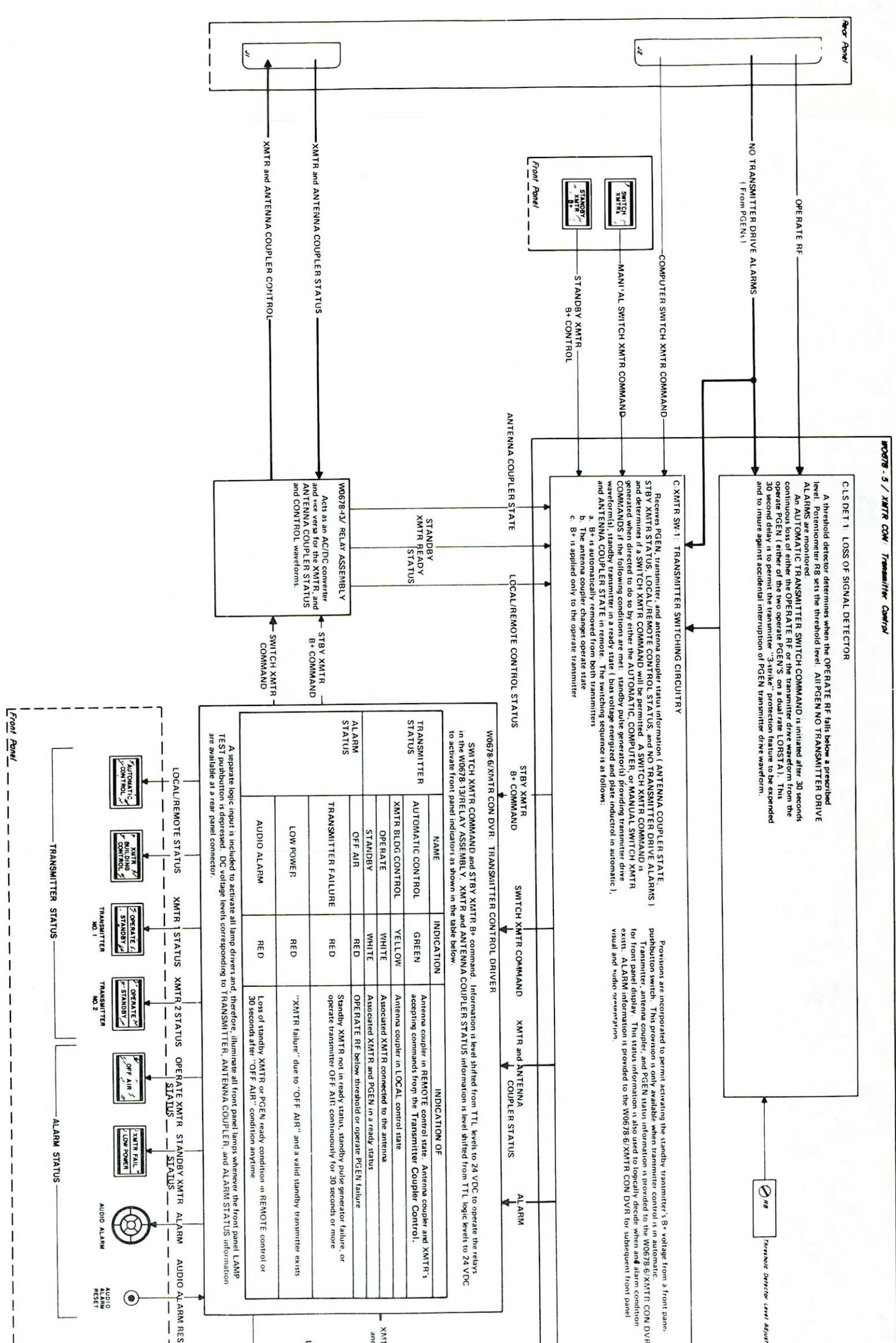
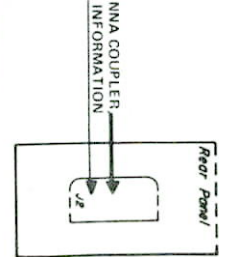


Figure 7.14. Transm
Functi



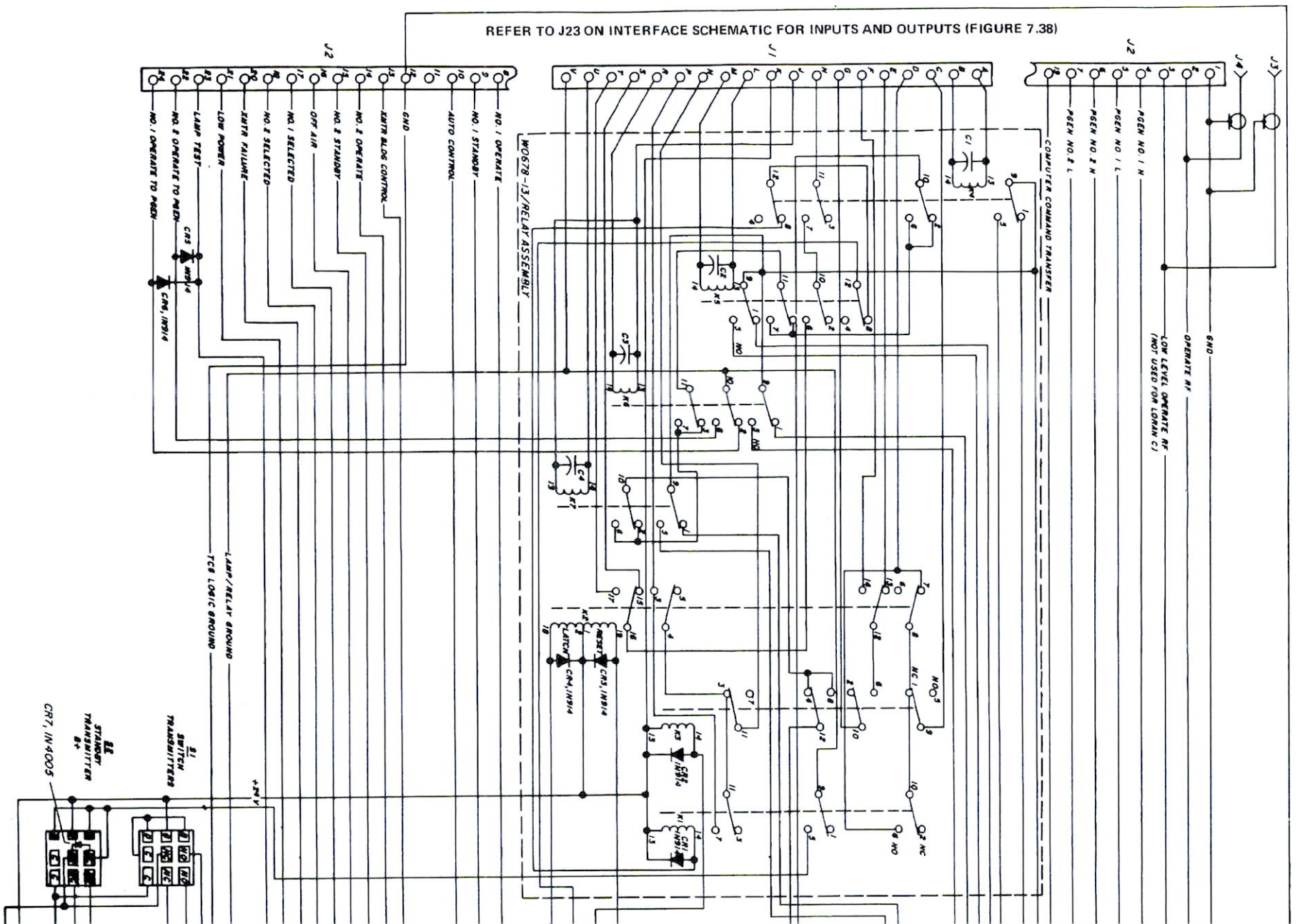
LIST FOR PGENS

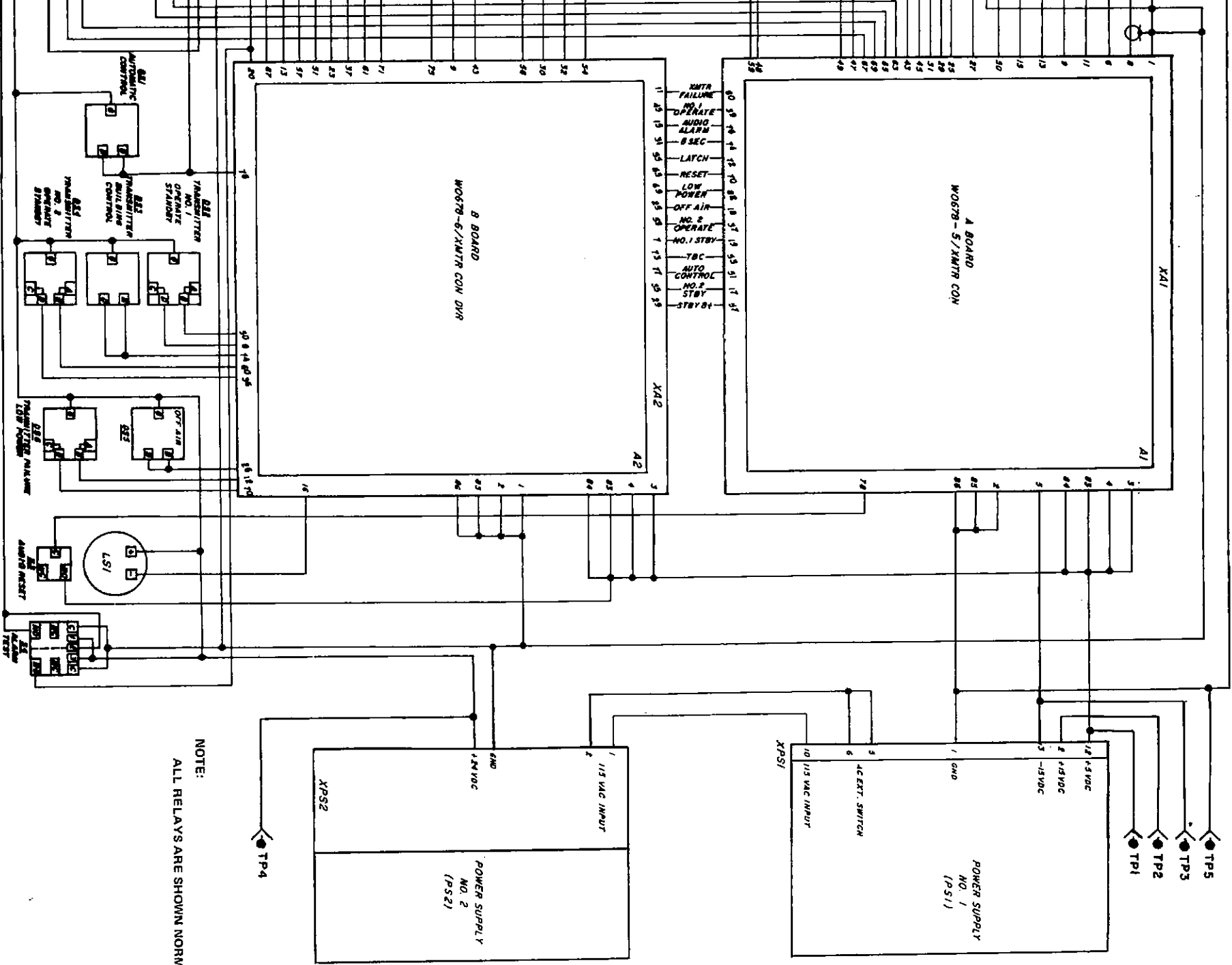
TEST



Receiver Coupler Control
Functional Block Text Diagram

7.29/7.30





NOTE:
ALL RELAYS ARE SHOWN NORMALLY DE-ENERGIZED.

Figure 7.15. Transmitter Coupler Control
Wiring Diagram

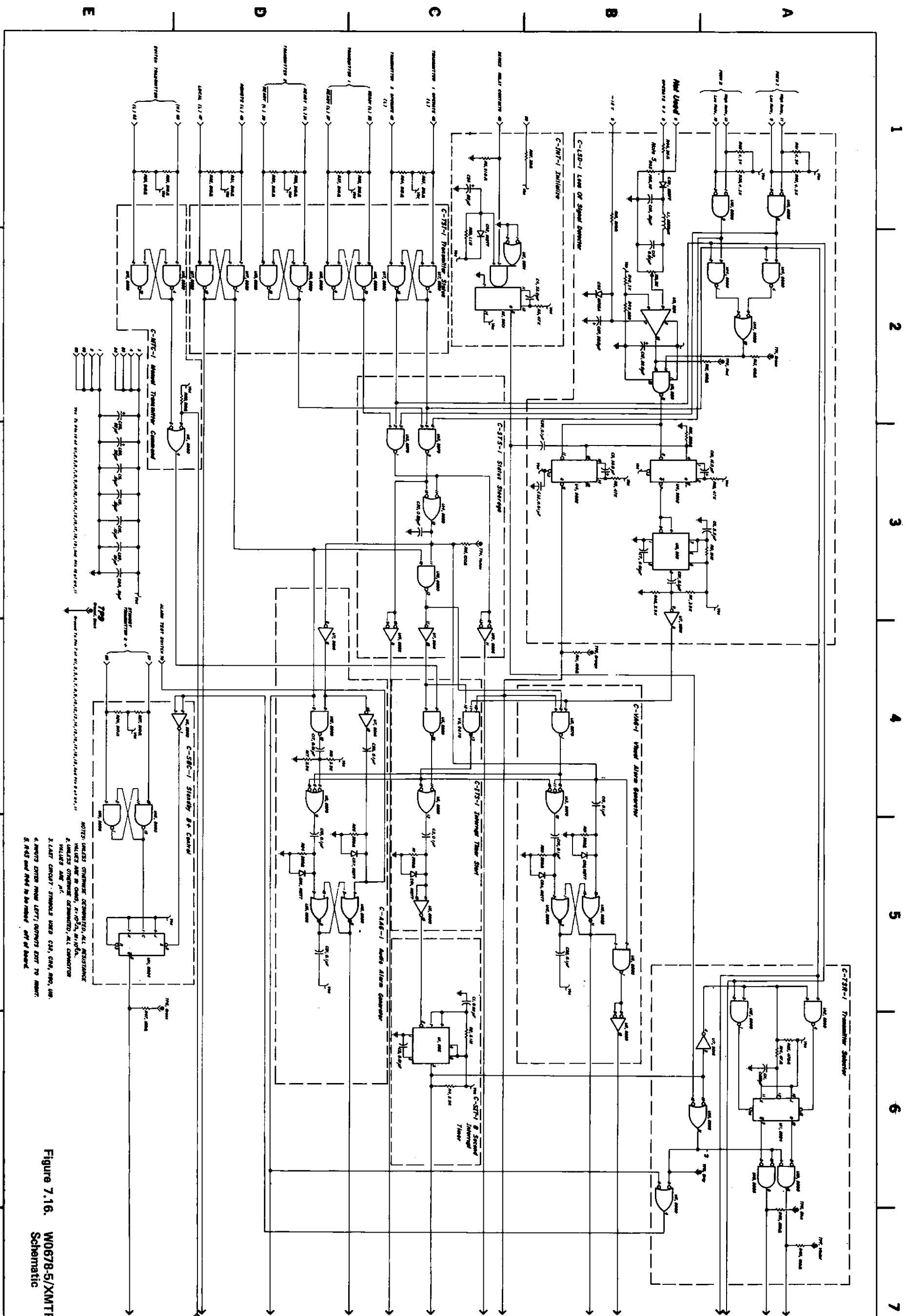
F.C. NO. 9 TO AN/FPN-60(V)/AN/FPN-60A(V)

7.31/7.32

PART LOCATION INDEX

REF. DESIG.	LOCATION	REF. DESIG.	LOCATION	REF. DESIG.
C1	5C	L1	1B	R40
C2	6C	R1	5C	R41
C3	5C	R2	6C	R42
C4	2B	R3	2B	R43
C5	3E	R4	6C	R44
C6	3A	R5	1C	R45
C7	3B	R6	3A	R46
C8	3E	R7	3B	R47
C9	3B	R8	3B	R48
C10	3A	R9	2B	R49
C11	6A	R10	3B	R50
C12	2B	R11	3A	R51
C13	2B	R12	4B	
C14	5B	R13	2A	TP1
C15	4B	R14	2A	TP2
C16	3E	R15	6A	TP3
C17	4D	R16	3C	TP4
C18	1B	R17	4D	TP5
C19	5D	R18	4D	TP6
C20	4C	R19	2B	TP7
C21	5D	R20	1B	TP8
C22	5B	R21	5B	TP9
C23	3E	R22	5B	
C24	3E	R23	1B	U1
C25	1C	R24	6A	U2
C26	3B	R25	5D	U3
C27	2B	R26	5C	U4
C28	2E	R27	4E	U5
C29	3E	R28	4E	U6
C30	3C	R29	1E	U7
C31	3B	R30	1E	U8
C32	3B	R31	2D	U9
CR1	5C	R32	1D	U10
CR2	2C	R33	1C	U11
CR3	2B	R34	1C	U12
CR4	5C	R35	1D	U13
CR5	5B	R36	1D	U14
CR6	5D	R37	1D	U15
CR7	5C	R38	1C	U16
CR8	1B	R39	1A	U17
				U18
				U19

3.	LOCATION
1A	1A
1A	1A
1B	1B
1B	1B
7A	7A
7A	7A
6E	6E
3B	3B
2B	2B
2C	2C
2C	2C
3B	3B
2A	2A
2A	2A
4B	4B
3C	3C
6E	6E
7A	7A
7A	7A
6A	6A
6A	6A
3E	3E
6C	6C
2C	2C
3B	3B
3B	3B
3B	3B
5B, 5C, 6B	5B, 5C, 6B
3D, 4C, 4D	3D, 4C, 4D
3B, 4C, 4D, 6A	3B, 4C, 4D, 6A
4B, 4C, 4D	4B, 4C, 4D
2B	2B
6A	6A
5E, 6A	5E, 6A
3C, 4D, 5A	3C, 4D, 5A
3C, 4B	3C, 4B
2A, 3C	2A, 3C
5B, 5C, 5D	5B, 5C, 5D
2D, 2E, 4E	2D, 2E, 4E
2C, 2D	2C, 2D
2C, 2D	2C, 2D
1A, 4C	1A, 4C



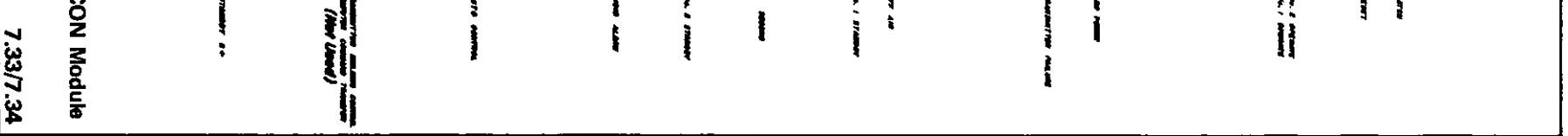
NOTES: UNLESS OTHERWISE SPECIFIED, ALL RESISTANCE VALUES ARE IN OHMS, R¹/10³, R²/10⁴, R³/10⁵, UNLESS OTHERWISE DESIGNATED, ALL CAPACITANCE VALUES ARE IN P.F.

1. LAMP CIRCUIT - STROBE USED (SM, CM, DM, EM, FM, GM, HM, IM, JM, KM, LM, NM, OM, PM, QM, RM, SM, TM, UM, VM, WM, XM, YM, ZM).

2. ALL WIRE ENDS FROM LEFT; OUTPUTS EXCEPT TO RIGHT.

3. R-FDS AND R-FS TO BE INHIBIT OUT OF BOARD.

Figure 7.16. W0678-5/XMTR C Schematic



A

B

C

D

E

7.33/7.34

CON Module

START (Not Used)

STOP

STOP

STOP

STOP

STOP

PA

REF. DESIG.	LOCATION	REF
C1	1B	
C2	2B	
C3	2B	
C4	2B	
C5	3B	
C6	4B	
C7	4B	
C8	4A	
C9	5A	
C10	5B	
C11	3C	
C12	6C	
C13	6C	
C14	1C	
C15	2C	
C16	2C	
C17	4C	
C18	6D	
C19	1D	
C20	2D	
C21	2C	
C22	2D	
C23	4D	
C24	6D	
C25	3B	
C26	6A	
C27	7B	
C28	1E	
C29	7E	
C30	4C	
C31	4B	
C32	6B	
CR1	2B	
CR2	3B	
CR3	6C	
CR4	1D	
CR5	2D	
CR6	1D	
CR7	2D	
CR8	6D	
E1	1A	
E2	7A	

RT LOCATION INDEX			
. DESIG.	LOCATION	REF. DESIG.	LOCATION
L1	6C	R43	6D
R1	2B	R44	6D
R2	2B	R45	2C
R3	3B	R46	3C
R4	2B	R47	3C
R5	3B	R48	4B
R6	5B	R49	7B
R7	5B	R50	3B
R8	5A	R51	6A
R9	5A	TP1	7A
R10	5B	TP2	6A
R11	6B	TP3	6A
R12	6B	TP4	4A
R13	7B	TP5	3A
R14	3C	TP6	3A
R15	4B	TP7	2A
R16	4C	TP8	2A
R17	5C	TP9	1A
R18	7A		
R19	7C	U1	2B
R20	1D	U2	3B
R21	2D	U3	4B
R22	3D	U4	6B
R23	4C	U5	2B
R24	1D	U6	3B
R25	2D	U7	4B
R26	3D	U8	5B
R27	3D	U9	6B
R28	3E	U10	2C
R29	3E	U11	3C
R30	3E	U12	4C
R31	4D	U13	5C
R32	4D	U14	6C
R33	4E	U15	2D
R34	4E	U16	3D
R35	5D	U17	4D
R36	5E	U18	5D
R37	5E	U19	6D
R38	5E		
R39	6D		
R40	6D		
R41	6E		
R42	6E		

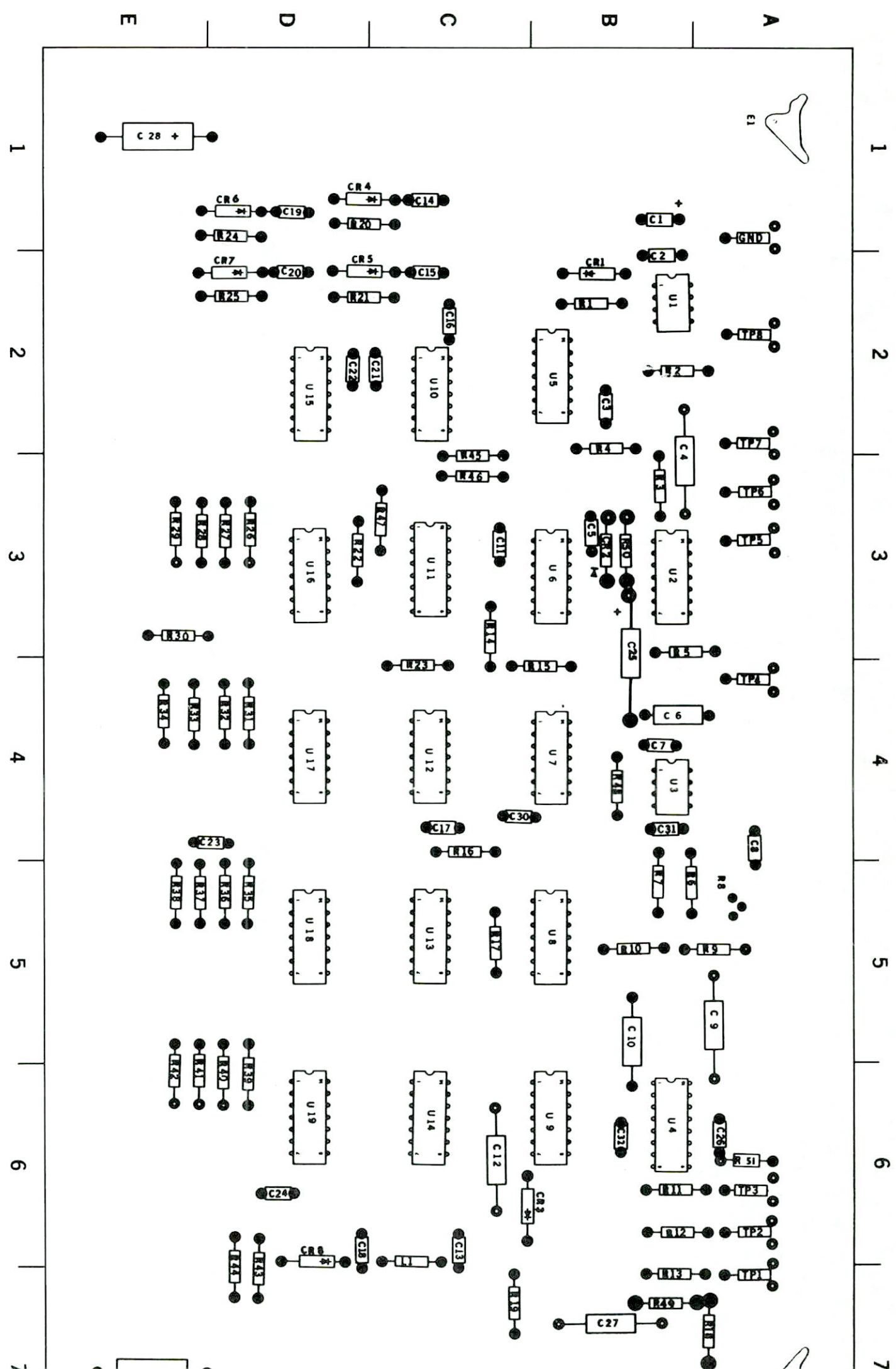
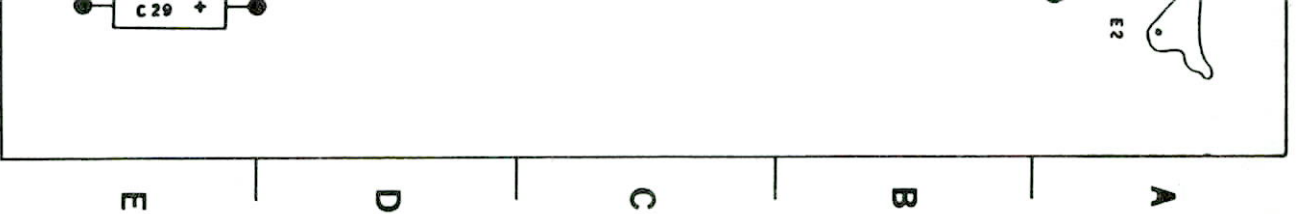


Figure 7.17. W0678-5/XM
Parts Locator



TR CON Module

7.35/7.36

PART LOCATION INDEX

REF. DESIG.	LOCATION
C1	2C 6A
C2	6A 6A
C3	68 68
C4	6C 6C
C5	38 38
C6	4C 4C
C7	3D 3D
C8	3A 3A
C9	3D 3D
C10	4B 4B
C11	BD BD
C12	BD BD
C13	4A 4A
C14	1E 1E
C15	1E 1E
C16	1E 1E
CR1	6C 6C
Q1	6A 6A
Q2	6A 6A
Q3	6C 6C
Q4	6C 6C
R1	7A 7A
R2	7A 7A
R3	7B 7B
R4	7C 7C
R5	6A 6A
R6	6A 6A
R7	NOT USED
R8	6C 6C
R9	6A 6A
R10	6A 6A
R11	5B 5B
TP1	7C 7C
TP2	7B 7B
TP3	7A 7A
TP4	7A 7A
TP5	7C 7C
U1	2C 2C
U2	2B 2B
U3	3C 3C
U4	2D 2D
U5	2A 2A
U6	2D 2D
U7	4B 4B
U8	4B 4B
U9	5D 5D
U10	4A 4A
U11	1C,2D,3C,4D,6A,6D
U12	2B,2D,6A,6C,6D
U13	2B,4A,4B,4D,6C,6D

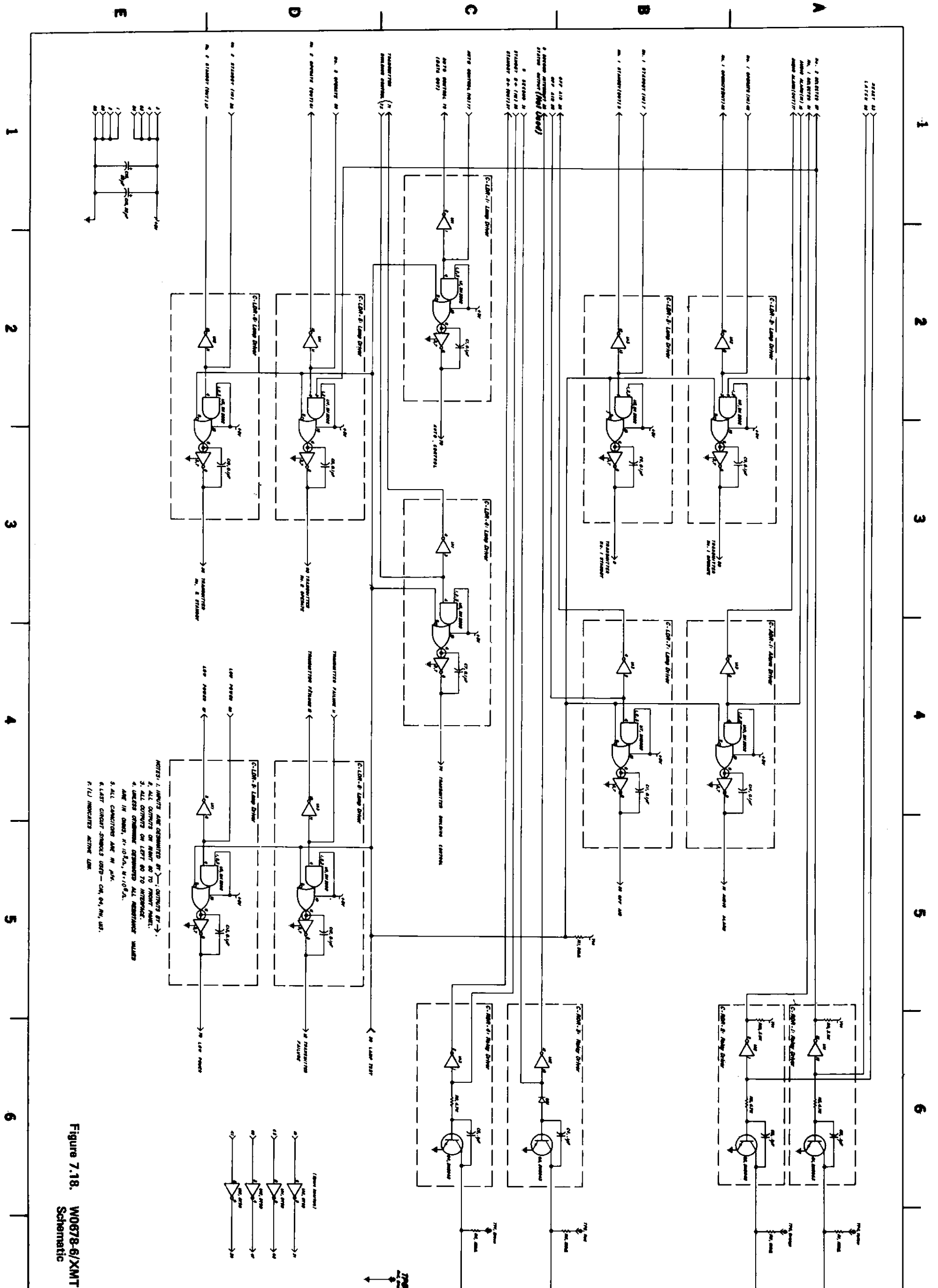


Figure 7.18. W0678-6/XMTR CO Schematic

DL 1000 70 20 (1.1)

A

DL 1000 70 20 (1.1)

B

DL 1000 70 20 (1.1)

C

DL 1000 70 20 (1.1)

D

N DVR Module

E

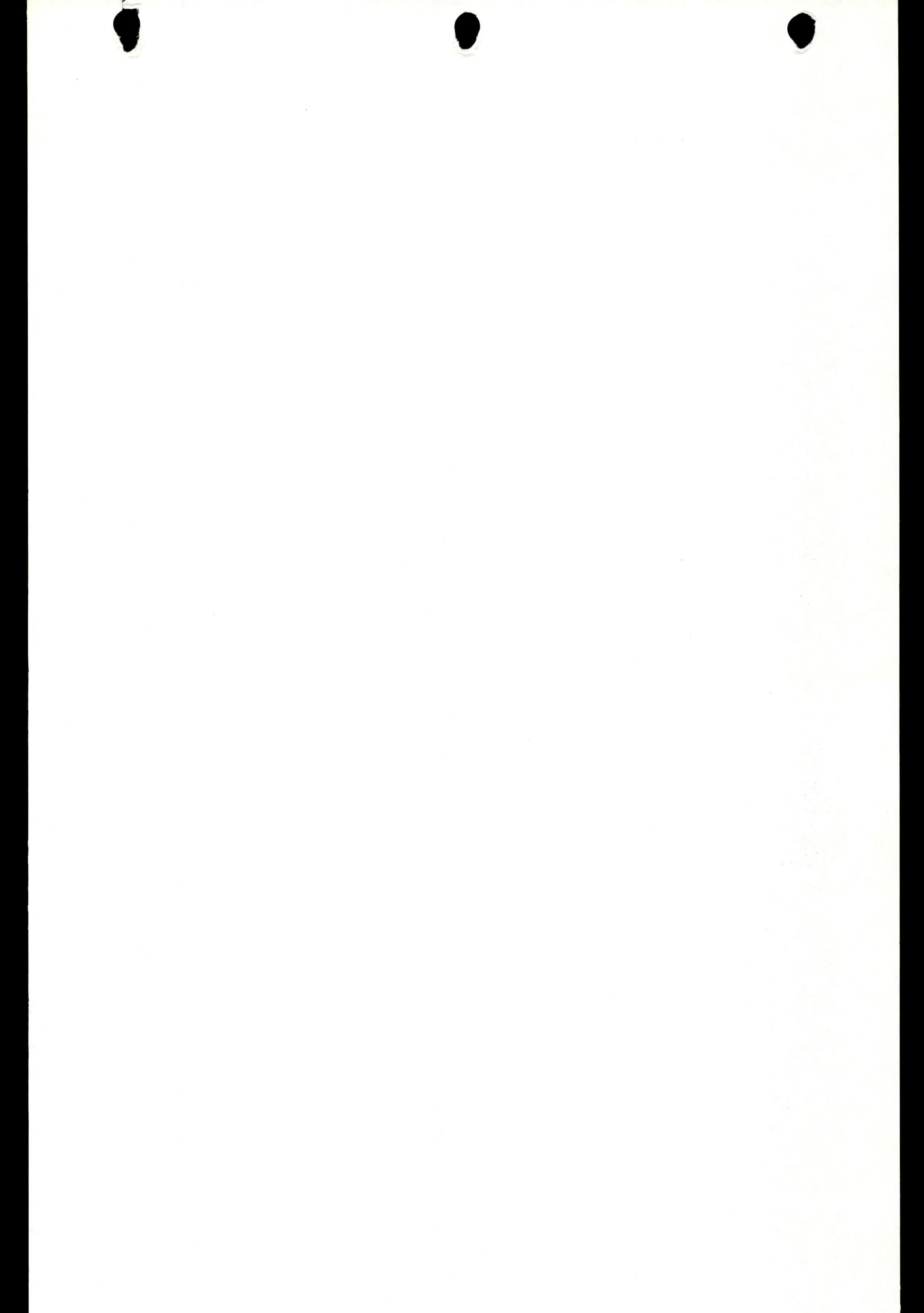
7.37/7.38

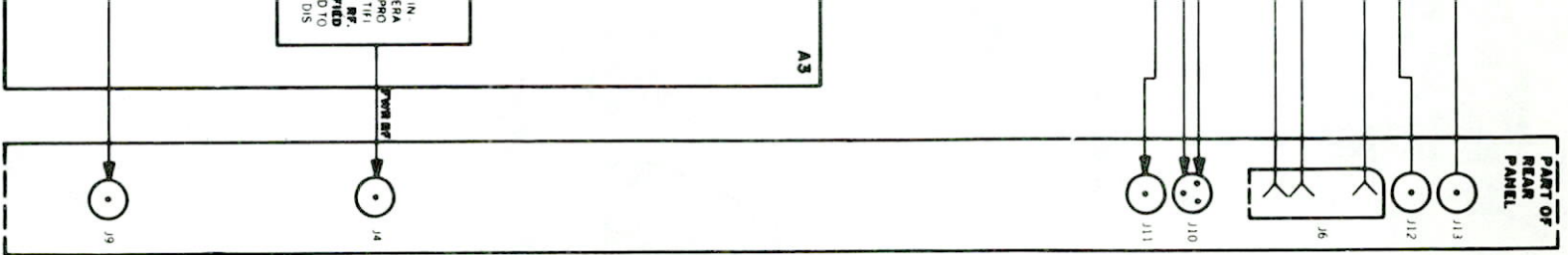
PART	REF. D
C1	
C2	
C3	
C4	
C5	
C6	
C7	
C8	
C9	
C1	
C1	
C1	
C1	
C1	
C1	
CR	
E1	
E2	
O1	
O2	
O3	
O4	
R1	
R2	
R3	
R4	
R5	
R6	
R7	
R8	
R9	
R1	
R1	
TP	
TP	
TP	
TP	
TP	
U1	
U2	
U3	
U4	
U5	
U6	
U7	
U8	
U9	
U1	
U1	
U1	



CON DVR Module

7.39/7.40





Ise Analyzer
Block Text Diagram

7.41/7.42

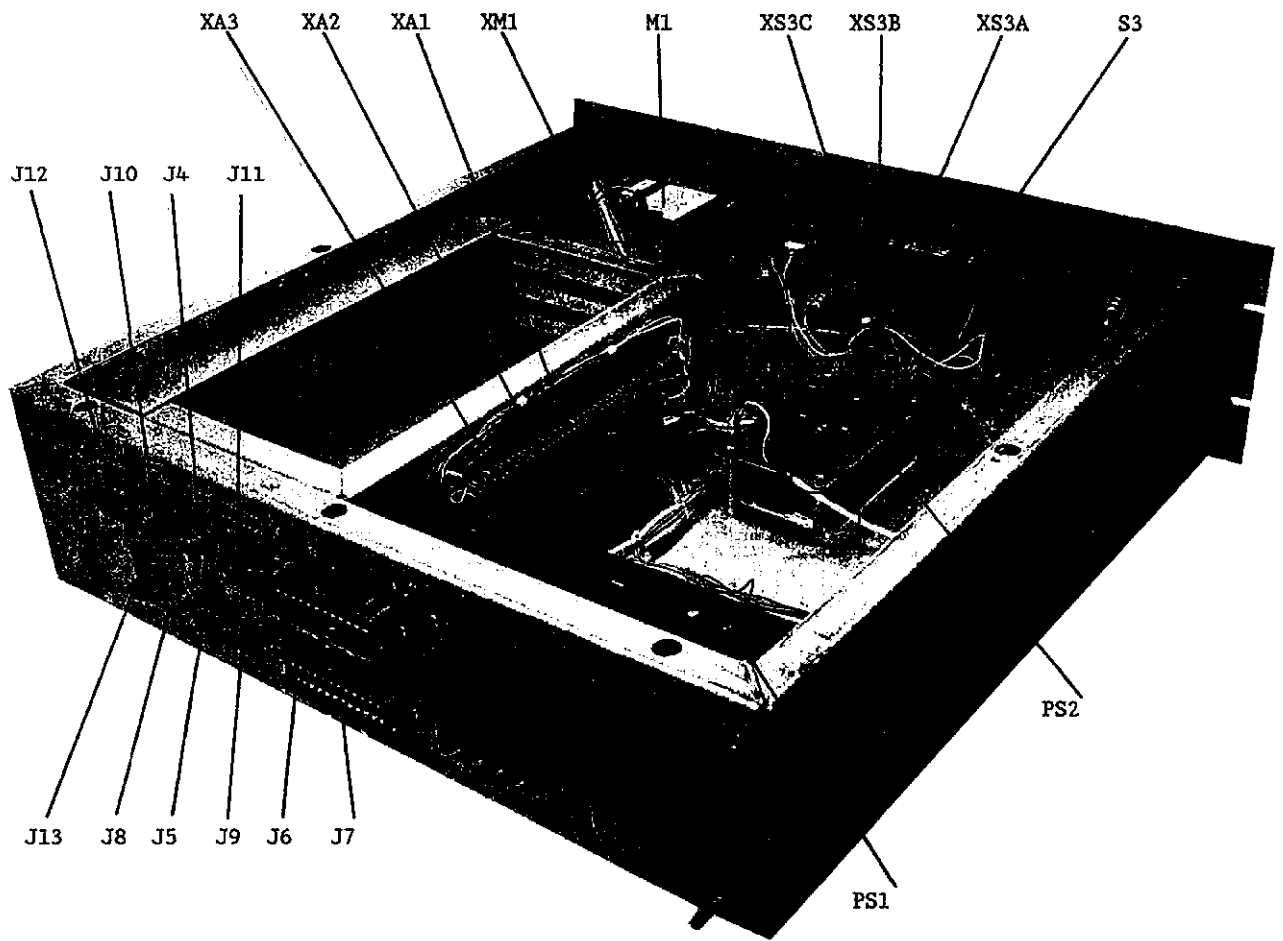
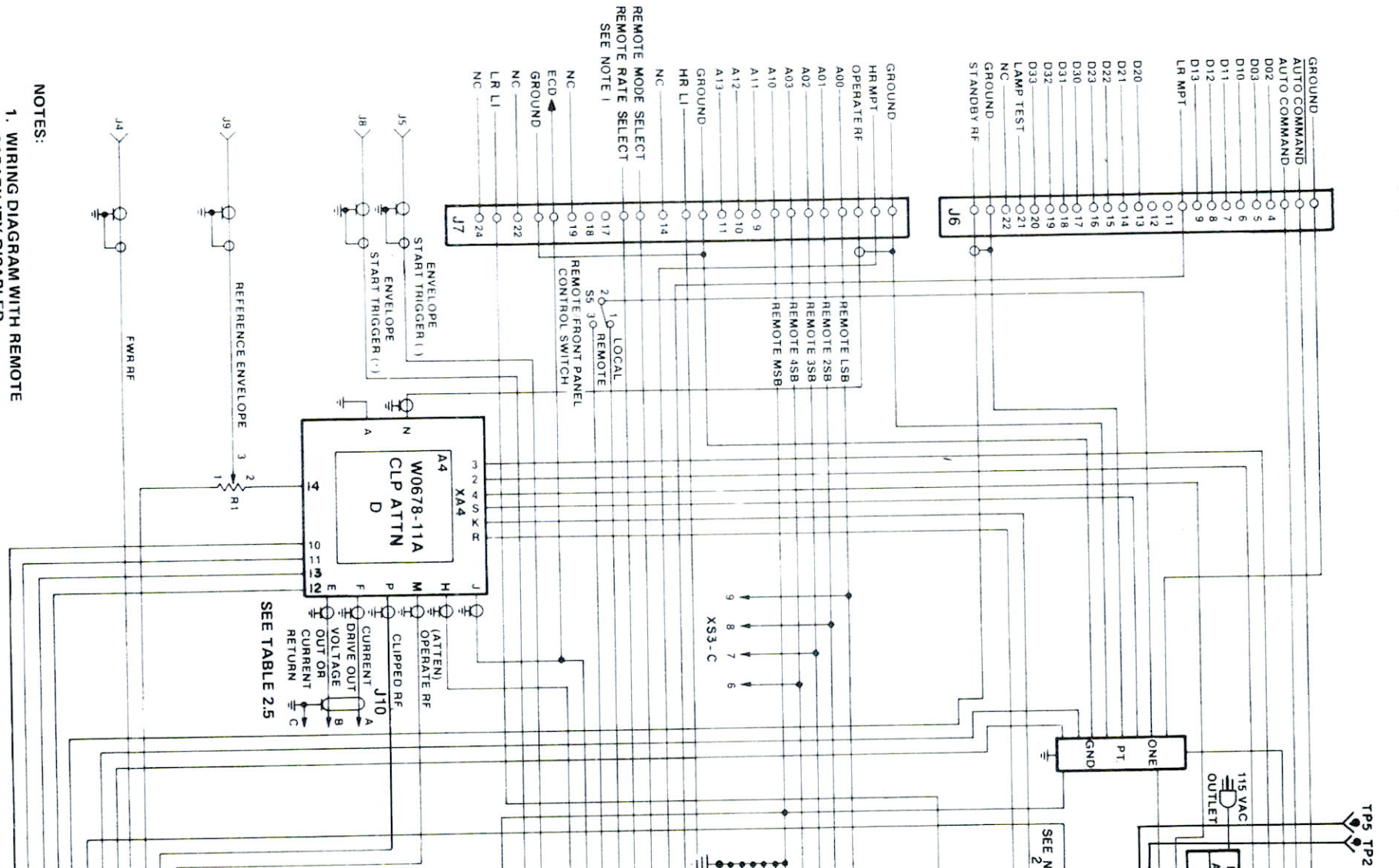
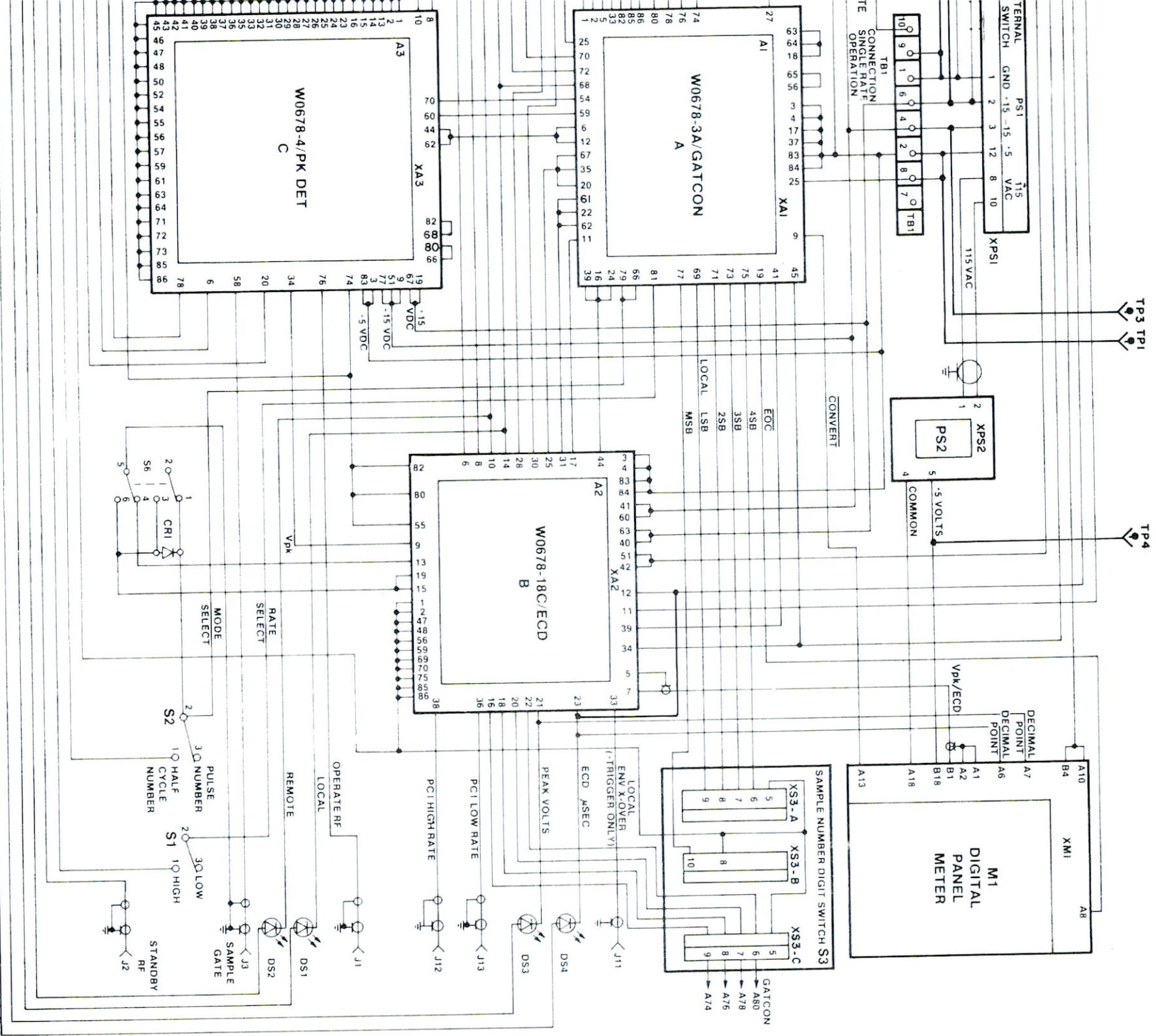


Figure 7.20A. Parts Location





- NOTES:
1. WIRING DIAGRAM WITH REMOTE CAPABILITY DISABLED.
 2. FOR DUAL-RATE CONNECTIONS OF TBI, REFER TO PARAGRAPH 2.6.1.2.

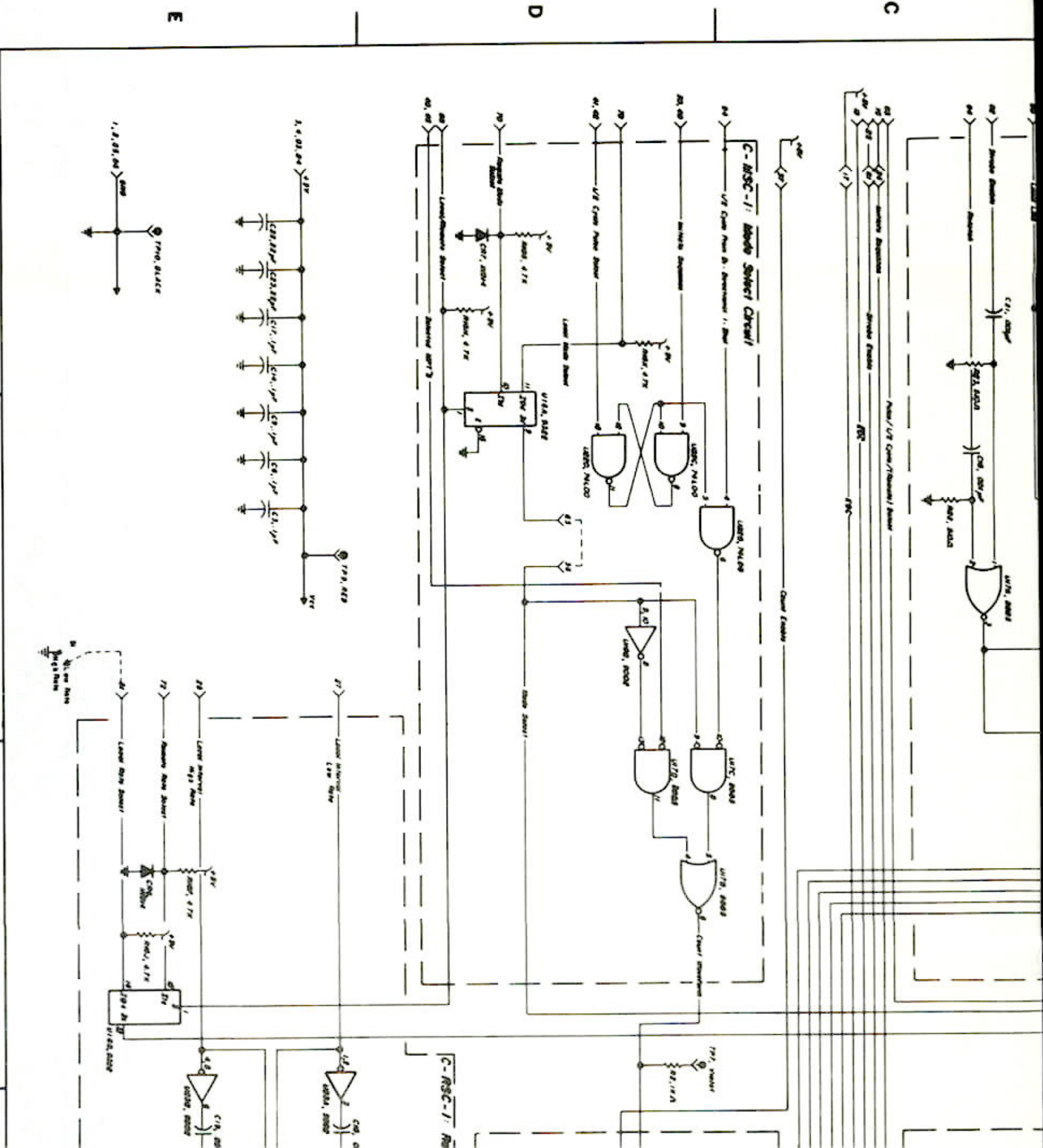


F.C. NO. 9 TO AN/FPN-60(V)/AN/FPN-60A(V)

Figure 7.21. Electrical Pulse Analyzer Wiring Diagram

7.43/7.44

C14	1E	TP1	8B
C15	2C	TP2	8A
C16	NOT USED	TP3	6D
C17	1E	TP4	7C
C18	4E	TP5	8B
C19	4E	TP6	3A
C20	6C	TP7	3D
C21	1C	TP8	7C
C22	1E	TP9	2E
C23	1E	TP10	1E
C24	NOT USED		2A
C25	7A		3A
CR1	1A	U1	5C
CR2	1A	U2	5D
CR3	1A	U3	5A
CR4	1A	U4	4A
CR5	1B	U5	6B
CR6	1B	U6	2A
CR7	3E	U7	2A
	1D	U8	5B,6D
R1	7C	U9	4B,5B
R2	3D	U10	5D
R3	3A	U11	4D
R4	8B	U12	4D,5B
R5	7C	U13	7A,7B
R6	6D	U14	2D,3E
R7	6A	U15	2C,3D
R8	6A	U16	2D,4D
R9	8A	U17	4E,6A
R10	8B	U18	5B,6B,6E
R11	4C	U19	6C
R12	4B	U20	2D
R13	4D	U21	3E,4E
R14	6A	U22	5D,5E
R15	4E	U23	7A,7B
	6C	U24	
		U25	



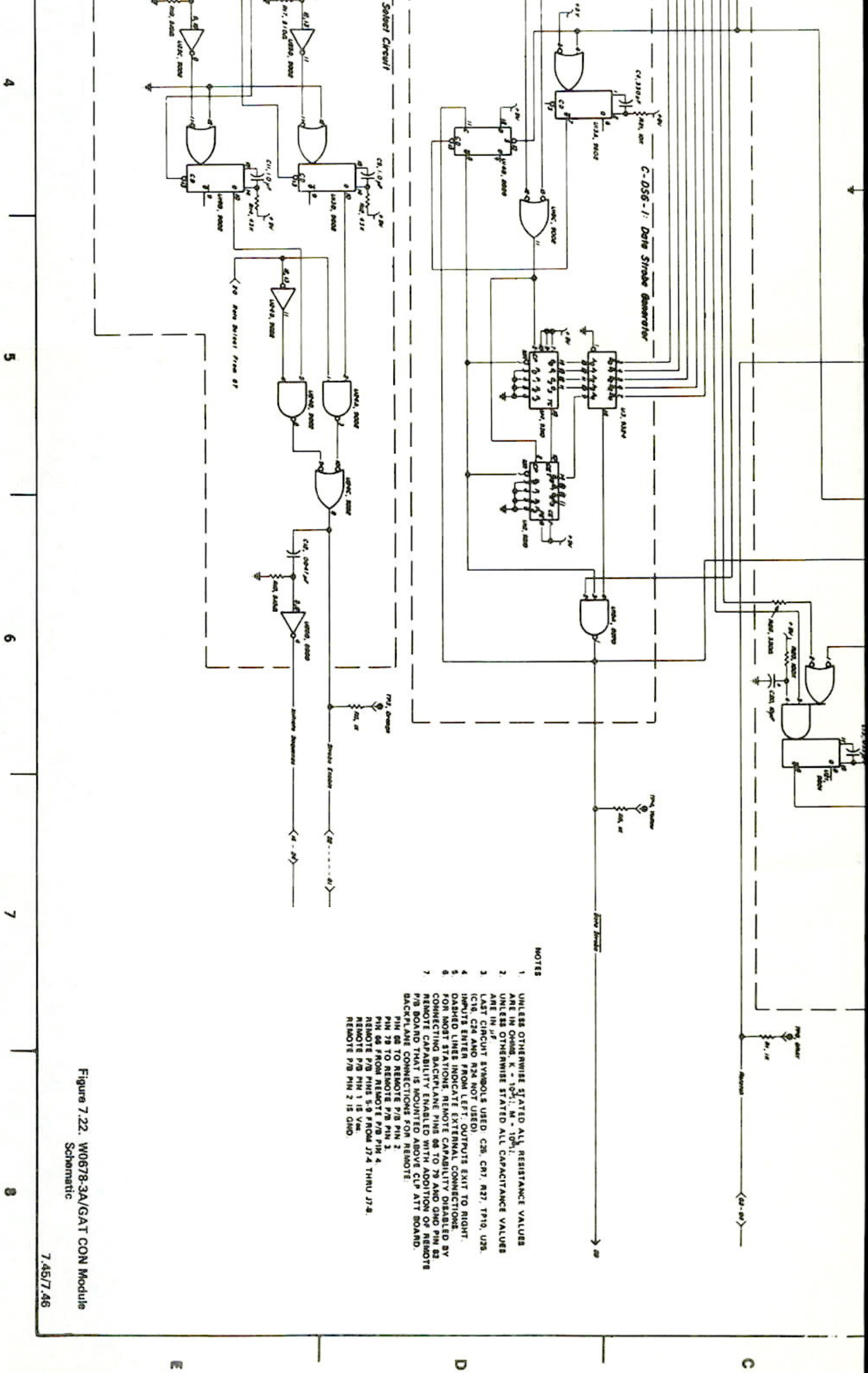
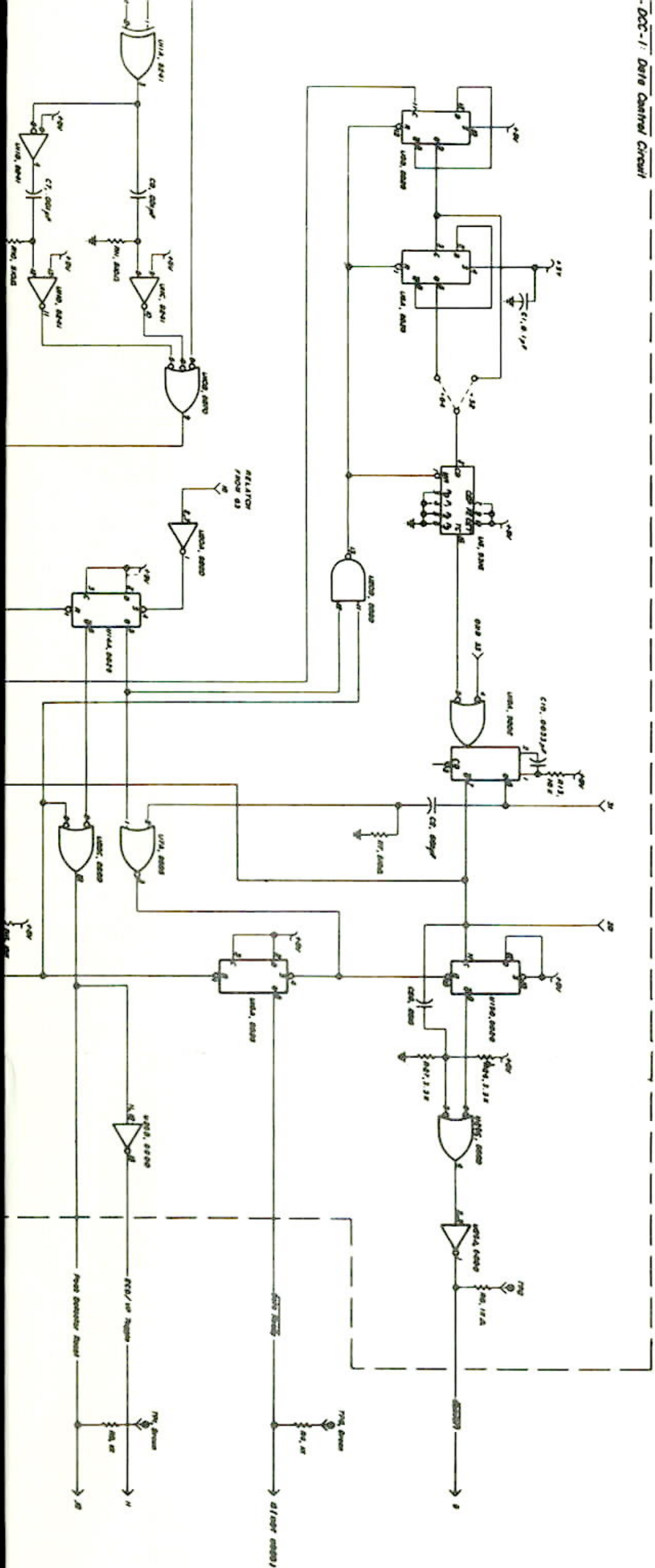


Figure 7.22. W0678-3A/GAT CON Module Schematic

DCC-1: Data Control Circuit



4

5

6

7

8

PART		REF. DESIG.	LOCAL
C1	6E		
C2	6B		
C3	1C		
C4	5C		
C5	5C		
C6	2C		
C7	4C		
C8	4C		
C9	5C		
C10	5C		
C11	5C		
C12	6D		
C13	7C		
C14	7C		
C15	3D		
C16	NOT US		
C17	NOT US		
C18	4E		
C19	5D		
C20	5D		
C21	7D		
C22	3E		
C23	1E		
C24	7E		
C25	7D		
CR1	1C		
CR2	1C		
CR3	1C		
CR4	1C		
CR5	1D		
CR6	1D		
CR7	1D		
E1	1A		
E2	7A		
R1	2B		
R2	2B		
R3	3B		
R4	4A		
R5	4B		
R6	5B		
R7	6B		
R8	7B		
R9	7B		
R10	4C		
R11	4C		
R12	5B		
R13	5C		
R14	5C		

LOCATION INDEX		
LOCATION	REF. DESIG.	LOCATION
7C	R15	7C
2D	R16	2D
5D	R17	5D
5D	R18	5D
6D	R19	6D
6D	R20	6D
5C	R21	5C
4D	R22	4D
4E	R23	4E
NOT USED	R24	NOT USED
6D	R25	6D
7D	R26	7D
7D	R27	7D
7A	TP1	7A
6A	TP2	6A
5A	TP3	5A
4A	TP4	4A
4A	TP5	4A
3A	TP6	3A
3A	TP7	3A
2A	TP8	2A
2A	TP9	2A
1A	TP10	1A
1B	U1	1B
3B	U2	3B
4B	U3	4B
5B	U4	5B
5B	U5	5B
6B	U6	6B
2C	U7	2C
3C	U8	3C
3C	U9	3C
4C	U10	4C
4B	U11	4B
5C	U12	5C
6B	U13	6B
6B	U14	6B
3D	U15	3D
3D	U16	3D
4D	U17	4D
4D	U18	4D
5C	U19	5C
6C	U20	6C
6C	U21	6C
4D	U22	4D
5D	U23	5D
6D	U24	6D
6D	U25	6D

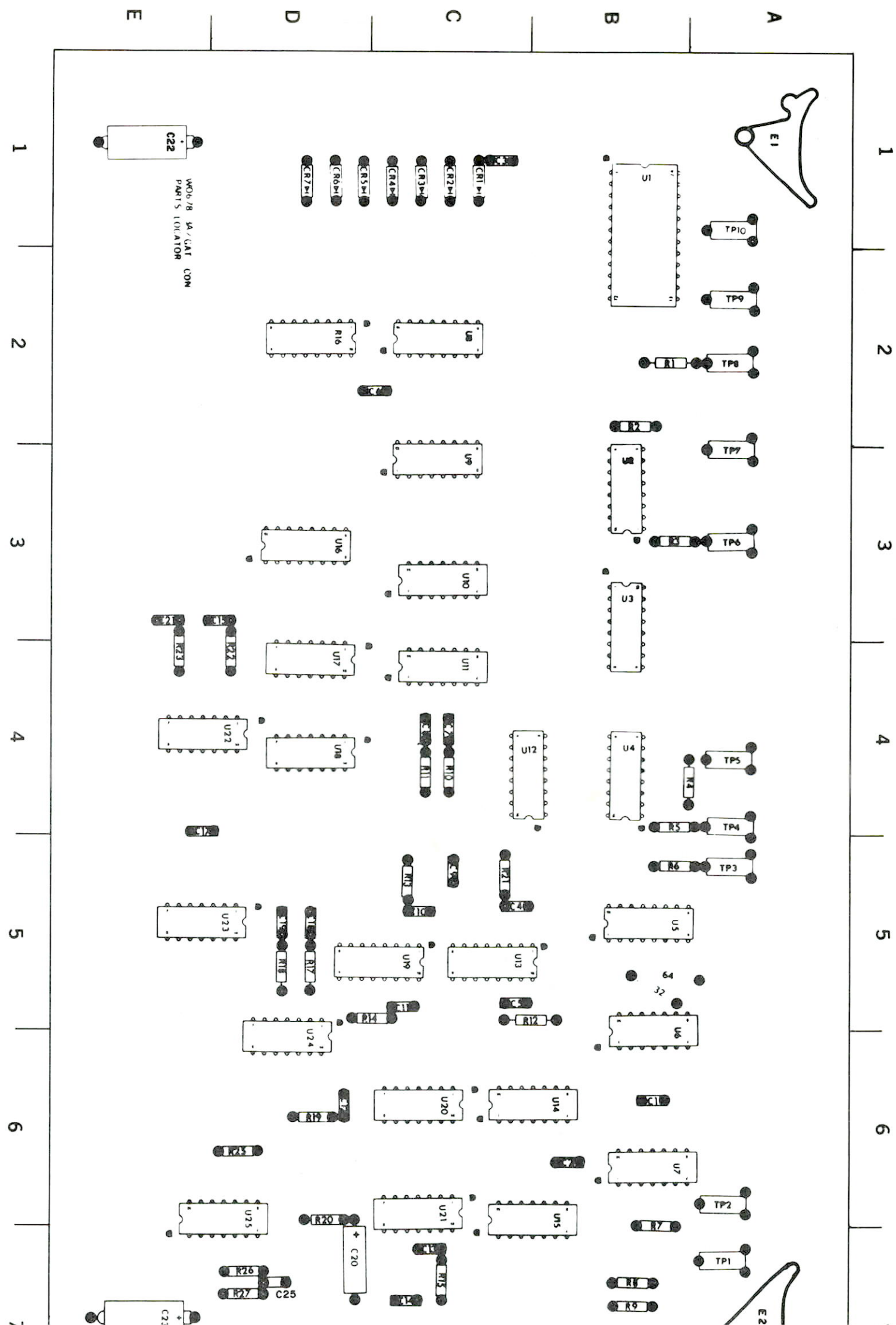


Figure 7.23. W0678-3A/GAT Parts Locator



7

7

A

B

C

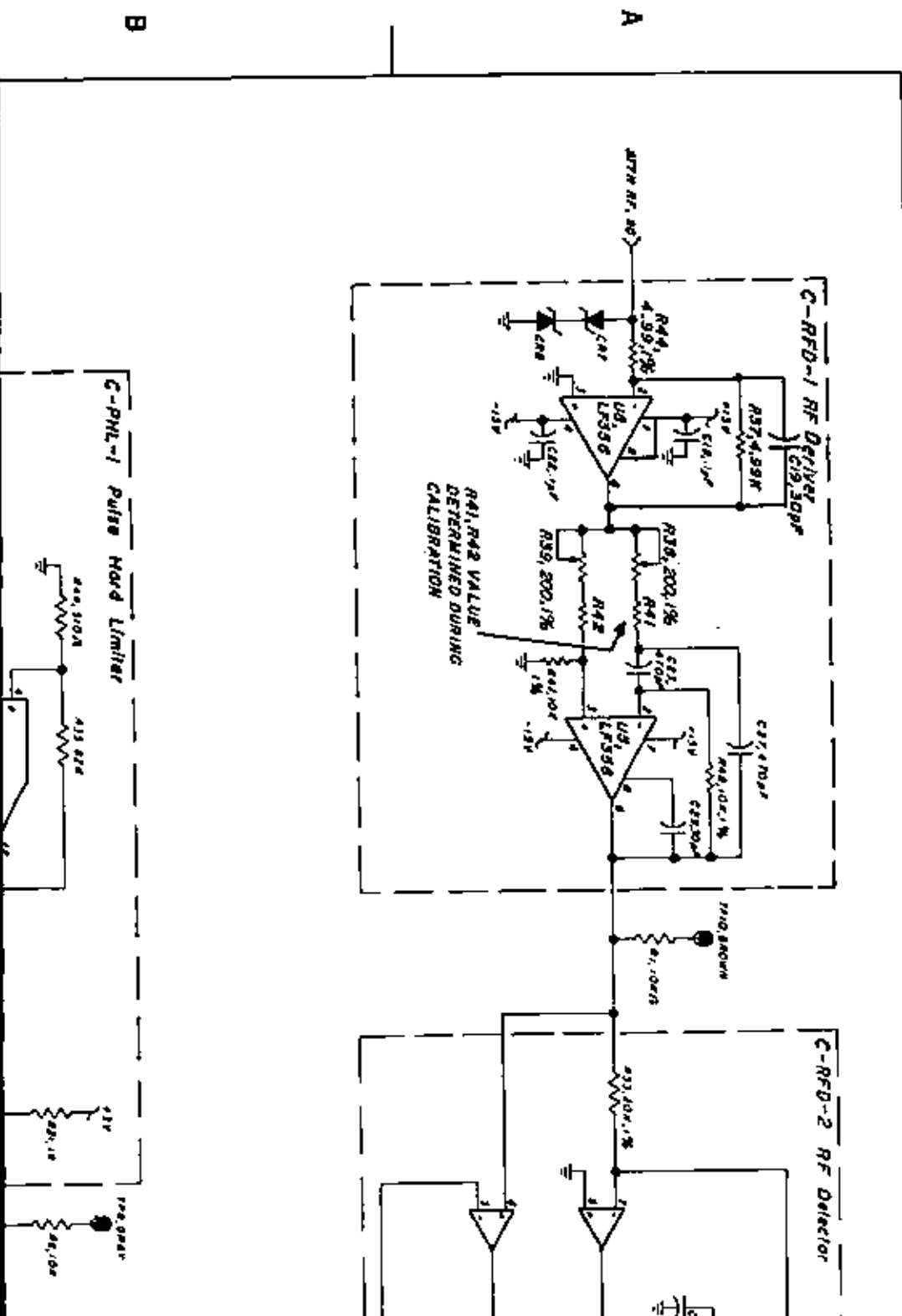
D

E

3ATCON Module
or

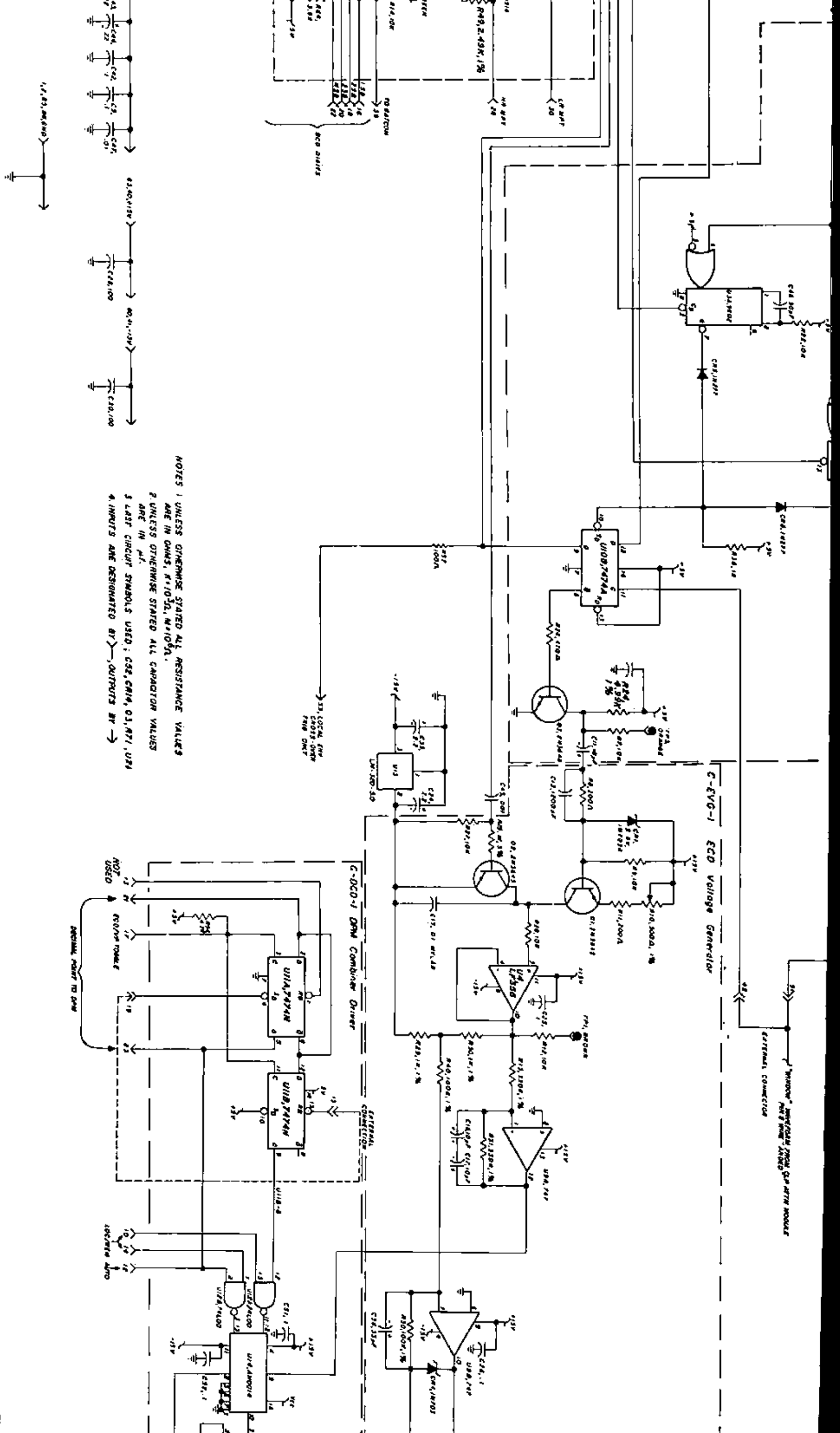
7.47/7.48

REF. DESIG.	LOCATION	PARTITION	REF. DESIG.	LOCATION
C1			R45	NOT USED
C2			R46	NOT USED
C3			R47	NOT USED
C4	3A	2C	R48	2A
C5	3A	3C	R49	2A
C6	3A	3D	R50	3D
C7	3A	2E	R51	7D
C8	4A	2E	R52	8D
C9	5A		R53	NOT USED
C10	4A		R54	1B
C11	4A		R55	6E
C12	3E		R56	8D
C13	4B		R58	8D
	5C			
	NOT USED			



1

2



NOTES 1 UNLESS OTHERWISE STATED ALL RESISTANCE VALUES ARE IN OHMS, R=10³Ω, M=10⁶Ω.
 2 UNLESS OTHERWISE STATED ALL CAPACITOR VALUES ARE IN μf.
 3 LAST CIRCUIT SYMBOLS USED: C92, C91, Q1, N71, U21
 4 INPUTS ARE DESIGNATED BY →, OUTPUTS BY ←

F.C. NO. 5 TO THE AN/FPN-60(V)

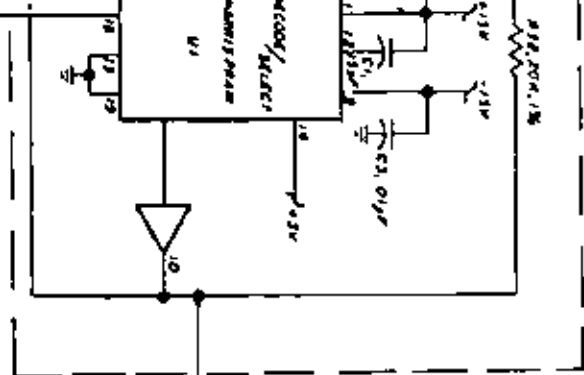
3

4

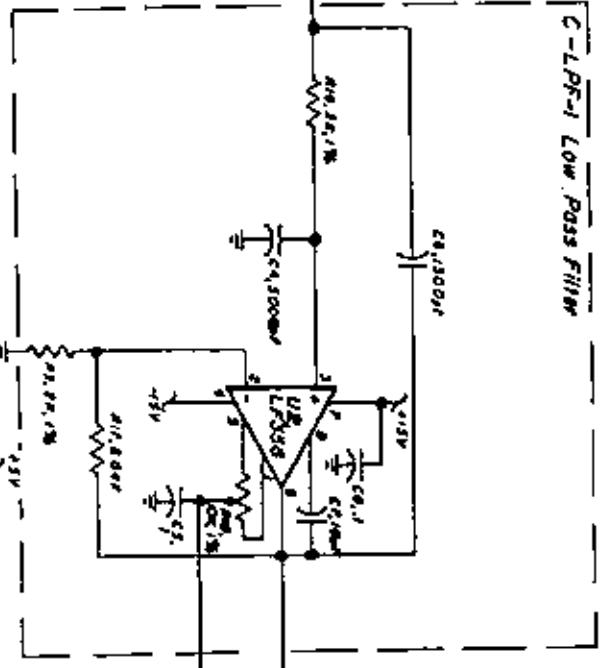
5

6

7

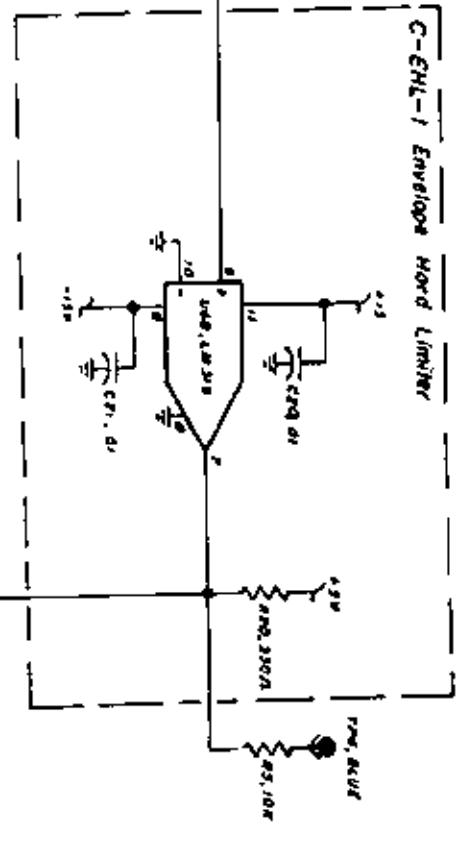


C-ESC-1 Envelope Start Cycle Stop Generator

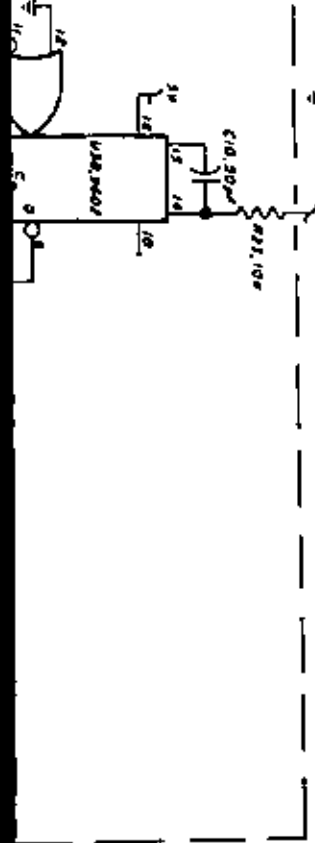


C-LPF-1 Low Pass Filter

TO U2, PIN 7



C-EHL-1 Envelope Hold Limiter





C

D

E

JUN 7.24. W0678-18C/ECD Module Schematic

7.49/7.50

8

A

B



REF. DESIG.	LOCATION	REF. DESIG.
C1	1B	CR1
C2	1B	CR2
C3	1B	CR3
C4	2B	CR4
C5	2B	CR5
C6	2B	CR6
C7	3B	CR7
C8	3B	CR8
C9	4B	CR9
C10	5B	CR10
C11	5B	CR11
C12	NOT USED	CR12
C13	5A	CR13
C14	5B	CR14
C15	6B	
C16	6B	
C17	7B	E1
C18	7B	E2
C19	1D	E3
C20	1C	E4
C21	3B	E5
C22	3C	
C23	1D	Q1
C24	2C	Q2
C25	6B	Q3
C26	7A	
C27	7C	R1
C28	2C	R2
C29	2C	R3
C30	2E	R4
C31	2C	R5
C32	3D	R6
C33	NOT USED	R7
C34	NOT USED	R8
C35	4D	R9
C36	6C	R10
C37	7C	R11
C38	3D	R12
C39	4C	R13
C40	4C	R14
C41	6C	R15
C42	7D	R16
C43	7D	R17
C44	1E	R18
C45	7E	R19
C46	5B	R20
C47	4B	R21
C48	6D	R22
C49	4D	R23
C50	6C	
C51	5C	
C52	6C	

PART LOCATION INDEX

LOCATION	REF. DESIG.	LOCATION	REF. DESIG.	LOCATION
5A	R24	5B	TP1	6A
NOT USED	R25	4A	TP2	5A
NOT USED	R26	6B	TP3	4A
7C	R27	6B	TP4	4A
4B	R28	6B	TP5	3A
2D	R29	7B	TP6	3A
2D	R30	7B	TP7	3A
4D	R31	7B	TP8	2A
4D	R32	1B	TP9	2A
4D	R33	1D	TP10	1A
4D	R34	3C		
4E	R35	4B		
4E	R36	1C		
4E	R37	1A		
NOT USED	R38	2C		
NOT USED	R39	7C		
5C	R40	1C		
5C	R41	2C		
5C	R42	2C		
5C	R43	3D		
5C	R44	3C		
6A	R45	NOT USED		
6B	R46	NOT USED		
5B	R47	2C		
1A	R48	2C		
2A	R49	5D		
2B	R50	7C		
3A	R51	7C		
2A	R52	NOT USED		
2A	R53	3D		
4A	R54	6D		
4A	R55	7D		
5A	R56	7D		
5A	R57	4E		
6A	R58	4D		
7A	R59	5C		
7A	R60	5D		
7A	R61	5D		
2A	R62	5D		
2B	R63	5D		
2B	R64	6D		
3B	R65	4E		
3B	R66	4D		
3C	R67	4D		
3B	R68	6C		
3B	R69	6C		
4B	R70	6C		
4B	R71	4A		
5B		5A		

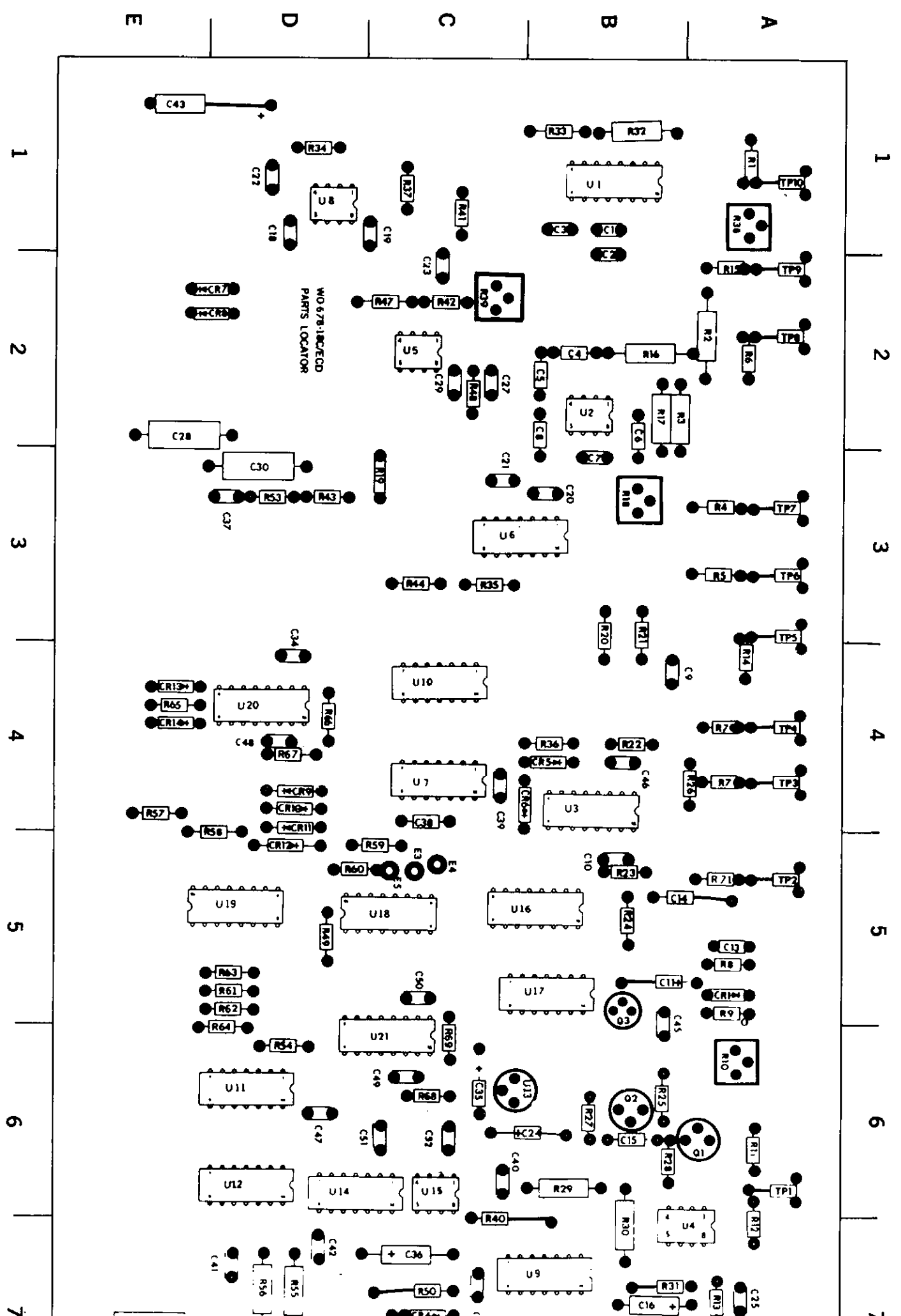
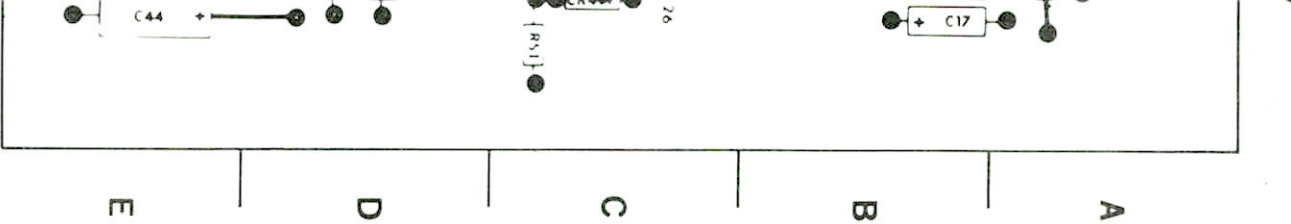


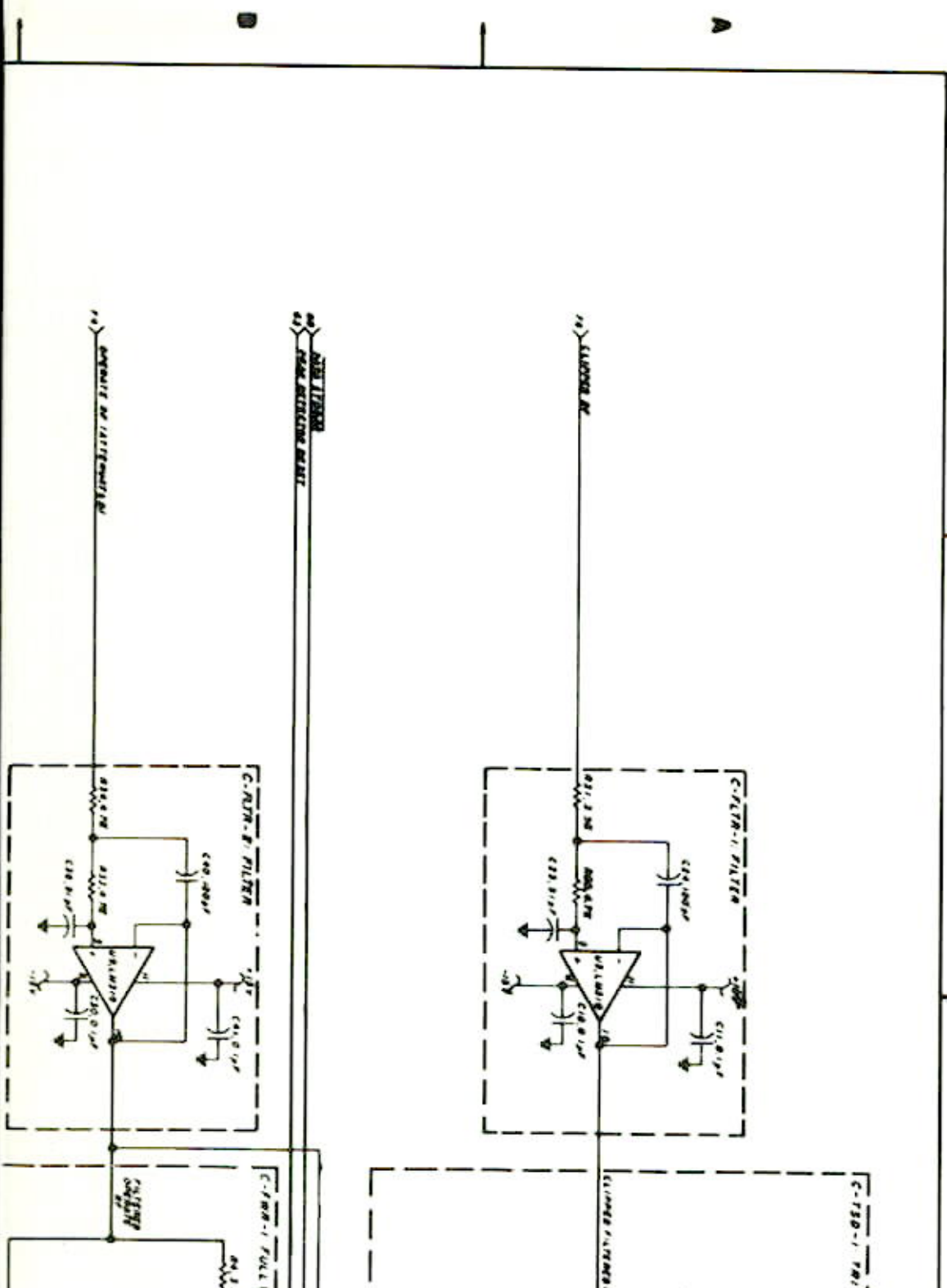
Figure 7.25. W0678-18C Parts Locat



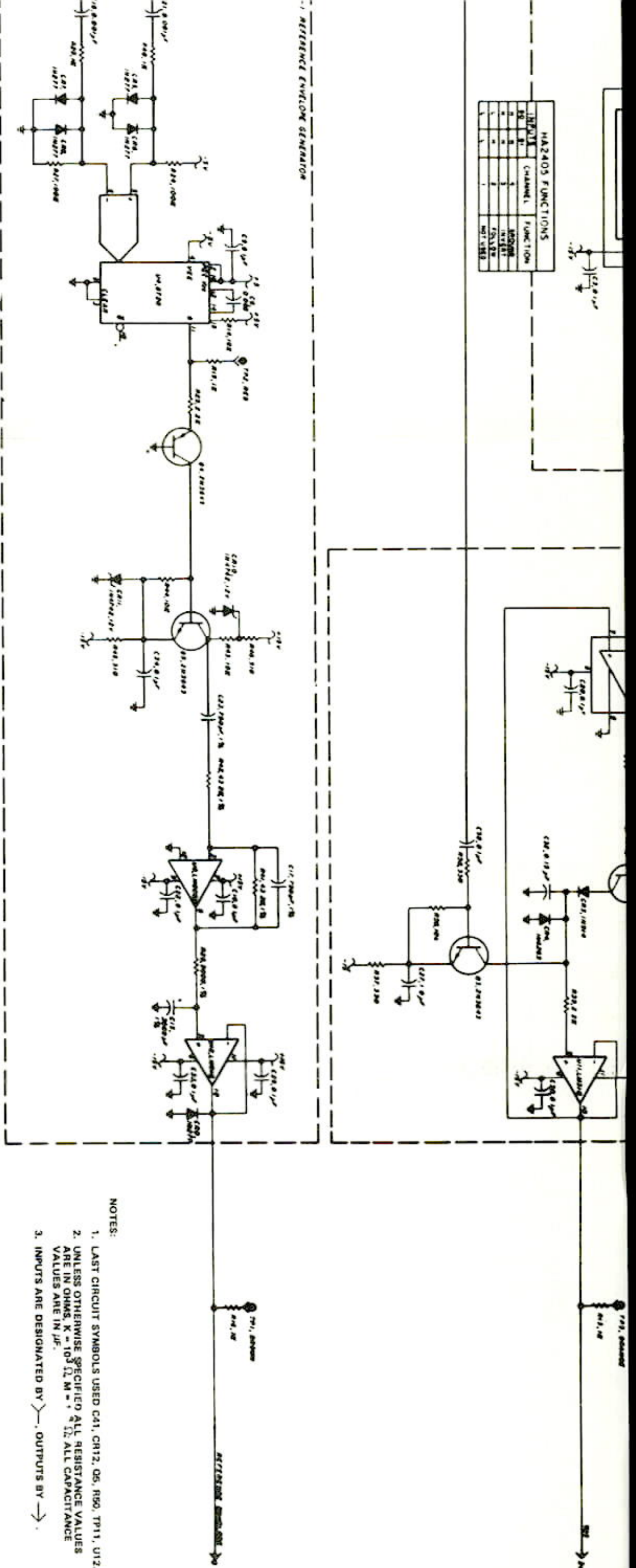
/ECED Module
OR

7.51/7.52

PART LOCATION INDEX					
REF. DESIG.	LOCATION	REF. DESIG.	LOCATION	REF. DESIG.	LOCATION
C1	4A	Q1	6B	R39	5B
C2	4C	Q2	6C	R37	6C
C3	4C	Q3	6C	R38	6C
C4	5B	Q4	5D	R39	6C
C5	4D	Q6	5D	R40	3D
C6	4D			R41	6D
C7	4B	R1	3B	R42	6D
C8	5B	R2	4A	R43	5D
C9	2E	R3	3A	R44	5D
C10	8D	R4	3B	R45	5D
C11	2A	R5	3B	R46	5D
C12	1D	R6	4A	R47	5D
C13	5A	R7	7A	R48	2E
C14	5B	R8	3A	R49	2D
C15	5D	R9	3A	R50	2E



HAZARD FUNCTIONS		
INPUT	CHANNEL	FUNCTION
1	1	MONITOR
2	1	MONITOR
3	1	MONITOR
4	1	MONITOR
5	1	MONITOR
6	1	MONITOR
7	1	MONITOR
8	1	MONITOR
9	1	MONITOR
10	1	MONITOR
11	1	MONITOR
12	1	MONITOR
13	1	MONITOR
14	1	MONITOR
15	1	MONITOR
16	1	MONITOR
17	1	MONITOR
18	1	MONITOR
19	1	MONITOR
20	1	MONITOR
21	1	MONITOR
22	1	MONITOR
23	1	MONITOR
24	1	MONITOR
25	1	MONITOR
26	1	MONITOR
27	1	MONITOR
28	1	MONITOR
29	1	MONITOR
30	1	MONITOR
31	1	MONITOR
32	1	MONITOR
33	1	MONITOR
34	1	MONITOR
35	1	MONITOR
36	1	MONITOR
37	1	MONITOR
38	1	MONITOR
39	1	MONITOR
40	1	MONITOR
41	1	MONITOR
42	1	MONITOR
43	1	MONITOR
44	1	MONITOR
45	1	MONITOR
46	1	MONITOR
47	1	MONITOR
48	1	MONITOR
49	1	MONITOR
50	1	MONITOR



- NOTES:
1. LAST CIRCUIT SYMBOLS USED CA1, CR12, Q5, R50, TP11, U12.
 2. UNLESS OTHERWISE SPECIFIED ALL RESISTANCE VALUES ARE IN OHMS, K = 10³ Ω, M = 10⁶ Ω. ALL CAPACITANCE VALUES ARE IN μF.
 3. INPUTS ARE DESIGNATED BY \curvearrowright , OUTPUTS BY \rightarrow .

Figure 7.26. W0678-4/PK DET Module Schematic

7.5317.54

4 5 6 7 8

REF. DESIG.	LOCATION	R
C1	2B	
C2	3B	
C3	4B	
C4	5B	
C5	6B	
C6	6B	
C7	2B	
C8	5B	
C9	6B	
C10	6C	
C11	2C	
C12	3C	
C13	3C	
C14	5C	
C15	6C	
C16	6C	
C17	6C	
C18	2C	
C19	3B	
C20	5C	
C21	6C	
C22	6C	
C23	6D	
C24	2D	
C25	2D	
C26	3D	
C27	4D	
C28	5D	
C29	6D	
C30	2E	
C31	2E	
C32	4D	
C33	6E	
C34	7D	
C35	1E	
C36	2E	
C37	3E	
C38	4E	
C39	5E	
C40	2E	
C41	2D	
CR1	4D	
CR2	4D	
CR3	4D	
CR4	4D	
CR5	5C	
CR6	5C	
CR7	6B	
CR8	6B	
CR9	6D	
CR10	6D	
CR11	7D	
CR12	5B	

PART LOCATION INDEX

EF. DESIG.	LOCATION	REF. DESIG.	LOCATION
E1	7A	R46	6D
E2	1A	R47	3B
Q1	4C	R48	3B
Q2	4C	R49	3A
Q3	4D	R50	3E
Q4	6C	TP1	6A
Q5	6D	TP2	6A
R1	2B	TP3	5A
R2	2A	TP4	5A
R3	2B	TP5	4A
R4	1B	TP6	4A
R5	2B	TP7	4A
R6	2B	TP8	3A
R7	3B	TP9	3A
R8	4B	TP10	3A
R9	2B	TP11	1A
R10	3A	U1	2B
R11	4B	U2	3B
R12	4B	U3	5B
R13	5B	U4	5B
R14	6B	U5	6B
R15	6B	U6	2C
R16	6B	U7	5C
R17	2B	U8	6C
R18	2B	U9	2D
R19	3C	U10	3D
R20	4C	U11	5D
R21	4C	U12	6D
R22	4C		6D
R23	4C		6D
R24	6B		6D
R25	6B		6D
R26	6B		6D
R27	6B		6D
R28	6C		6D
R29	7C		6D
R30	2D		7D
R31	2D		7D
R32	3E		7D
R33	2E		
R34	2E		
R35	4D		
R36	4D		
R37	4D		
R38	4E		
R39	4E		
R40	6C		
R41	6C		
R42	6D		
R43	6D		
R44	6D		
R45	7D		

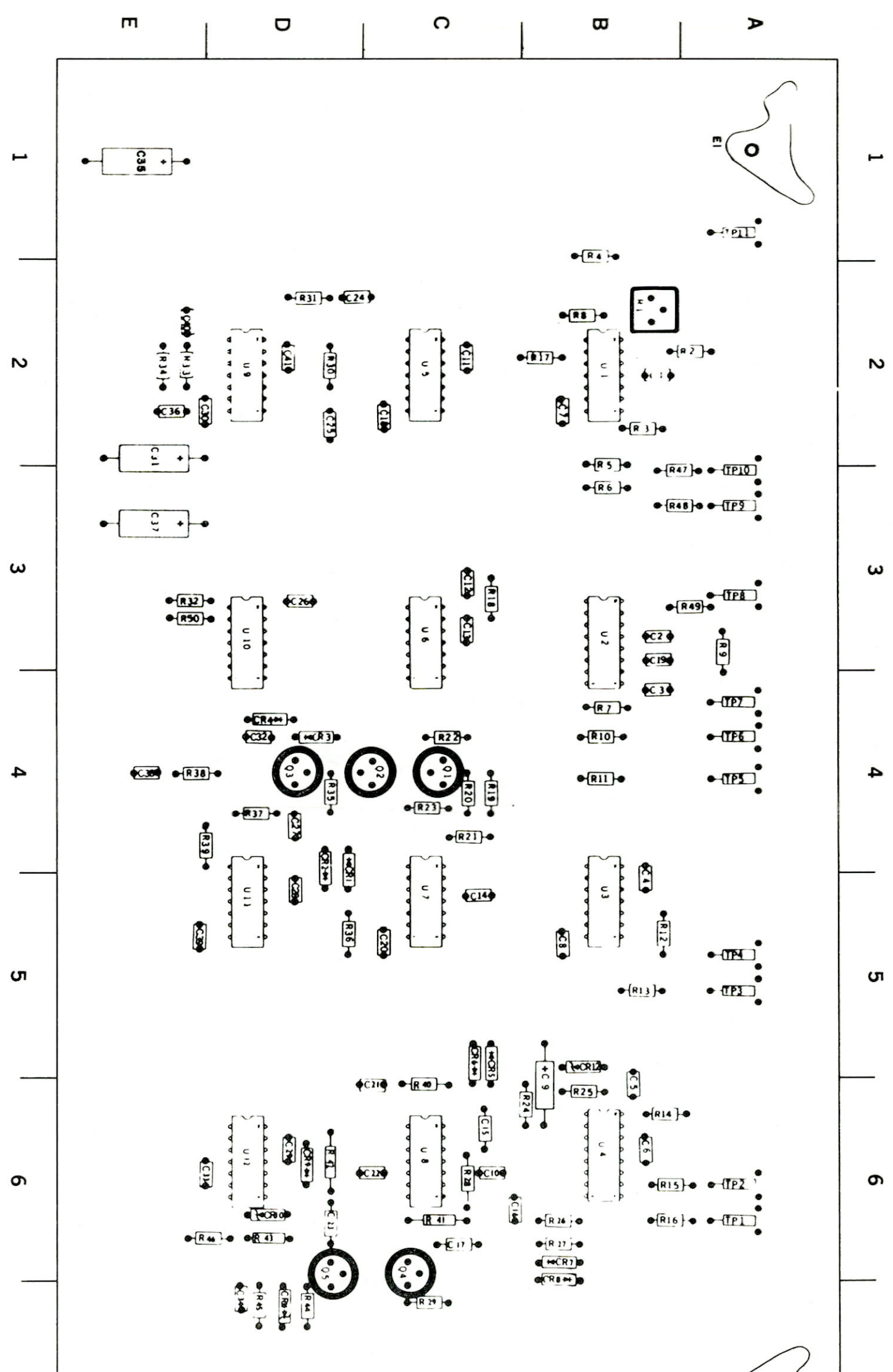
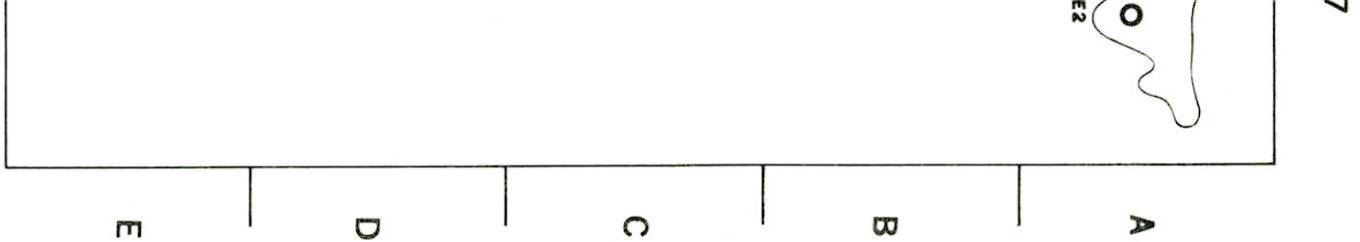


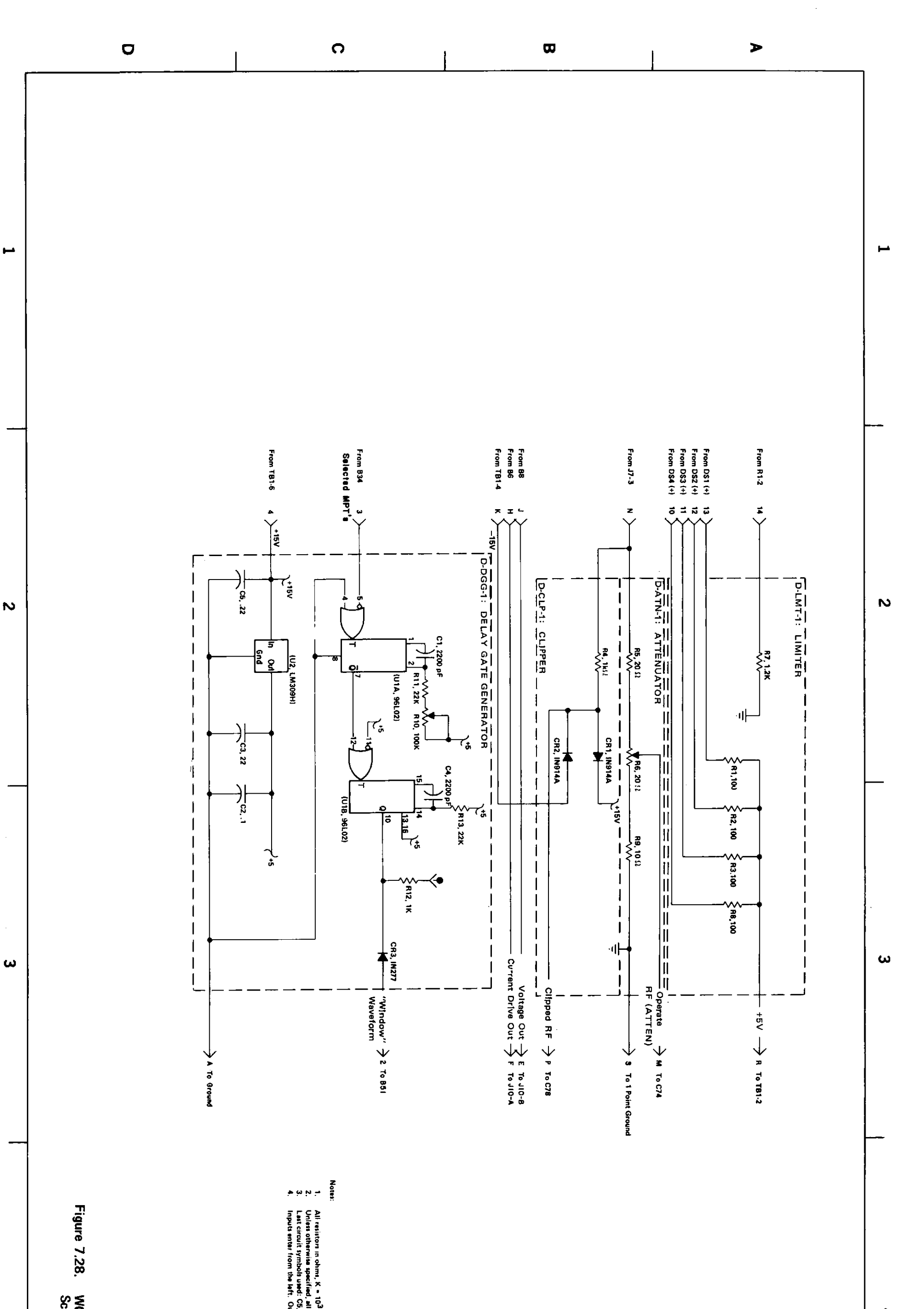
Figure 7.27. W0678-4/
Parts Loc



PK DET Module
ator

7.55/7.56

PART LOCATION INDEX	
REF. DESIG.	LOCATION
C1	2C
C2	3C
C3	2C
C4	3C
C5	2C
CR1	2B
CR2	2B
CR3	3C
R1	2A
R2	3A
R3	3A
R4	2B
R5	2B
R6	2B
R7	2A
R8	3A
R9	3B
R10	2C
R11	2C
R12	3C
R13	3B
TP1	3C
U1	2C,3C
U2	2C



- Notes:
1. All resistors in ohms, K = $10^3 \Omega$.
 2. Unless otherwise specified, all capacitance values in μF .
 3. Lead circuit symbols used: CS, UZ, R13, CR3, TP1.
 4. Inputs enter from the left. Outputs exit from right.

Figure 7.28. W0678-11A/CLP A1 Schematic

A

B

C

D

RTN Module

7.57/7.58

PART LOCATION INDEX	
REF. DESIG.	LOCATION
C1	2A
C2	2B
C3	2B
C4	1B
C5	1B
CR1	2C
CR2	2C
CR3	2B
R1	1C
R2	1D
R3	1D
R4	1C
R5	2C
R6	3C
R7	1D
R8	1D
R9	2D
R10	3A
R11	2A
R12	3B
R13	2B
TP1	3B
U1	1A
U2	1B

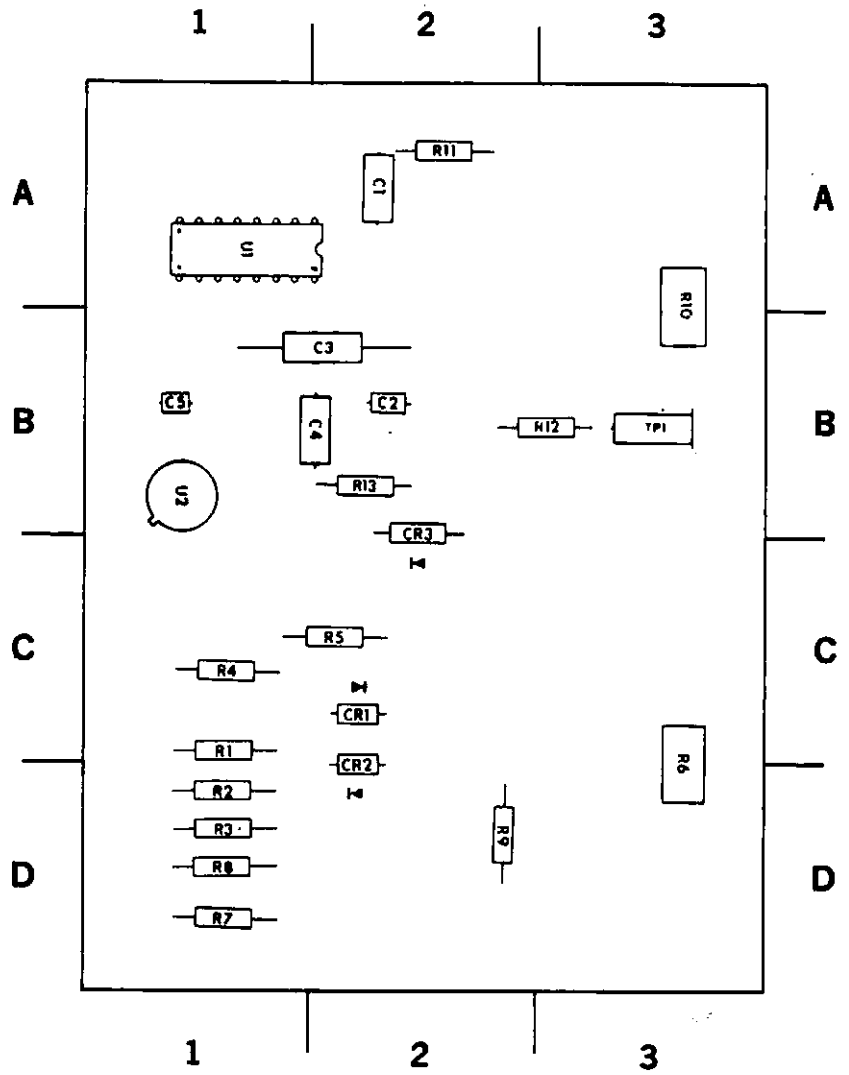
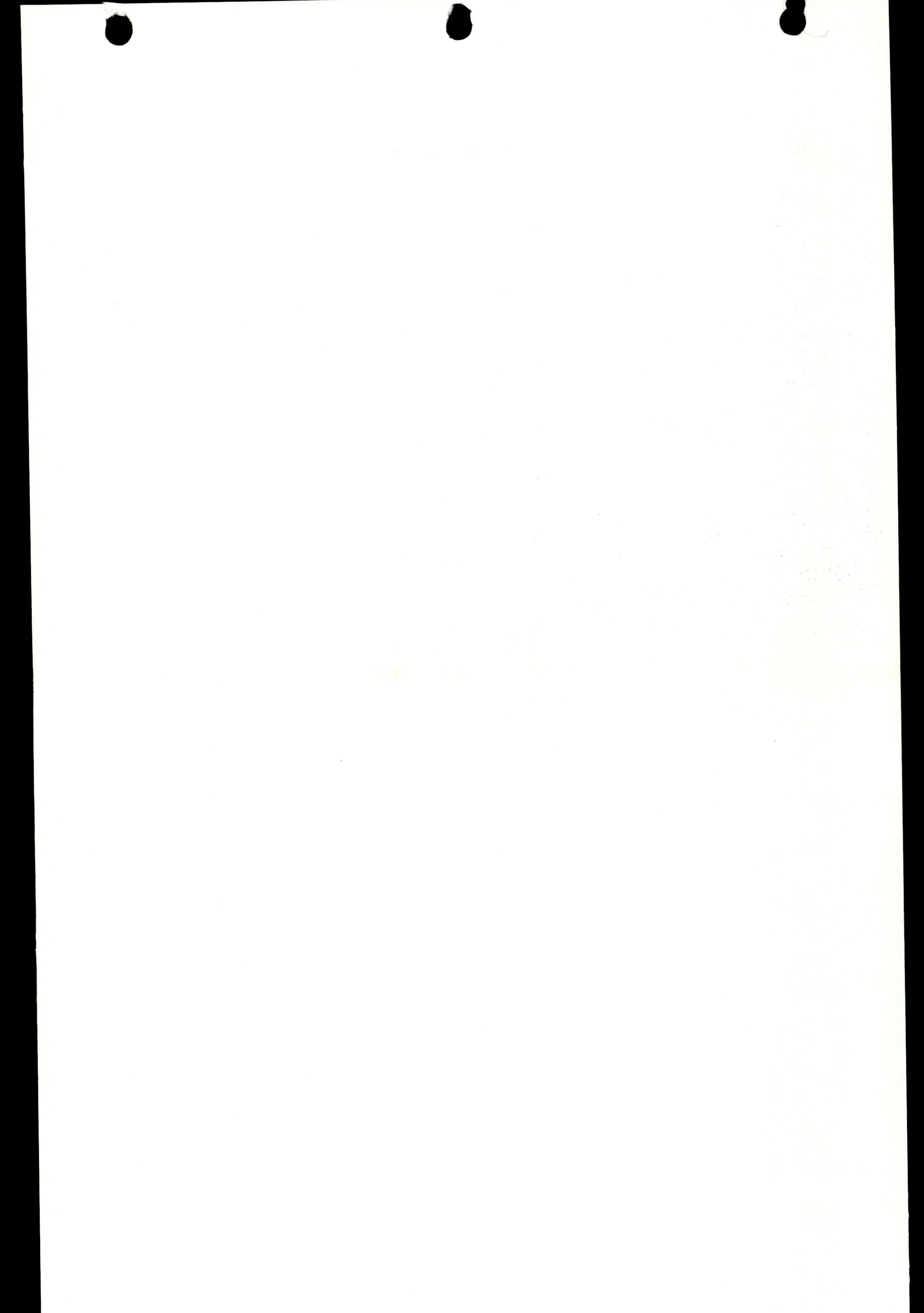


Figure 7.29. W0678-11A/CLP ATTN Module Parts Locator





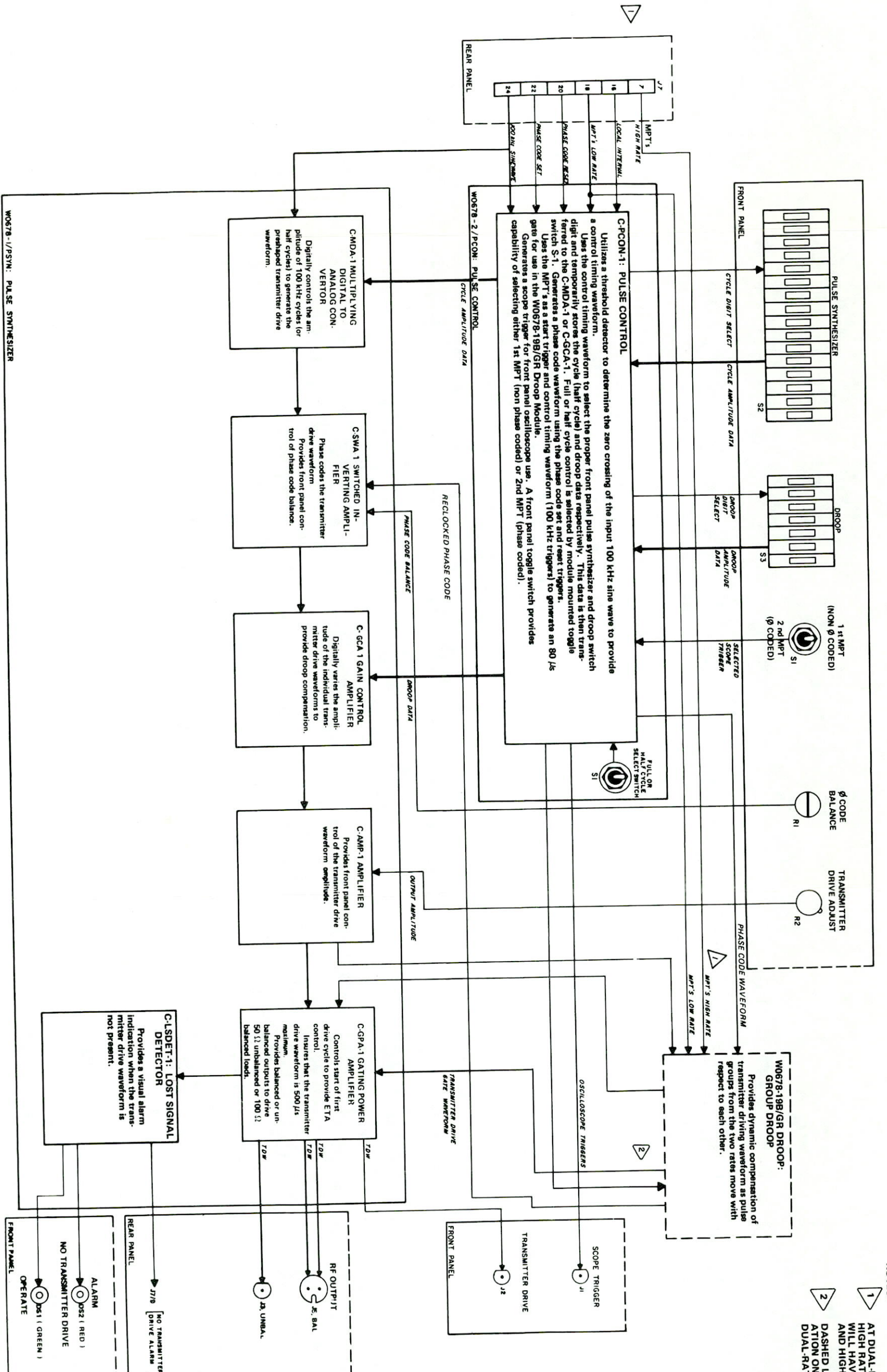
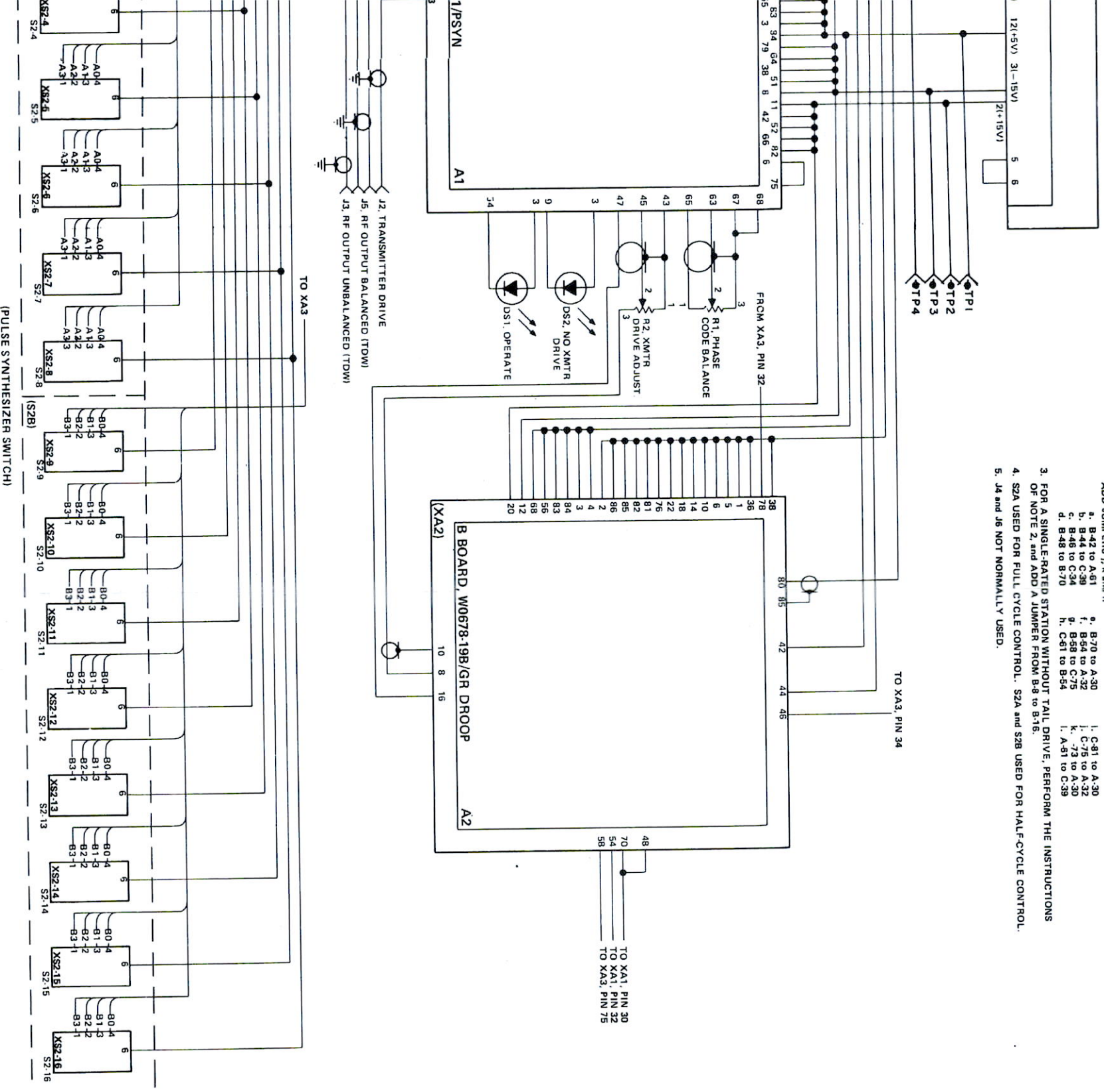


Figure 7.30. Pulse Generator Functiona

ATED STATIONS THE
PGEN's (PGEN 1H & 2H)
LOW RATE MPT's ON J7-7
RATE MPT's J7-18.

NE IS DUAL-RATE OPER-
Y. REMOVE JUMPER FOR
E OPERATION.

erator
Block Text Diagram
7.61/7.62

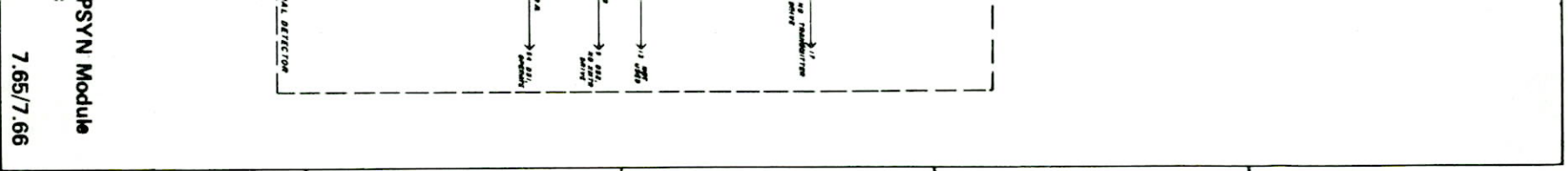


- NOTES:
1. THIS WIRING DIAGRAM IS FOR STATIONS (DUAL or SINGLE-RATED) WITH TAIL DRIVE.
 2. FOR A DUAL-RATED STATION WITHOUT TAIL DRIVE: REMOVE JUMPERS a - l, and ADD JUMPERS j, k and l.
 3. FOR A SINGLE-RATED STATION WITHOUT TAIL DRIVE: PERFORM THE INSTRUCTIONS OF NOTE 2, and ADD A JUMPER FROM B-8 to B-16.
 4. S2A USED FOR FULL CYCLE CONTROL. S2A and S2B USED FOR HALF-CYCLE CONTROL.
 5. J4 and J6 NOT NORMALLY USED.
- | | | |
|-----------------|-----------------|-----------------|
| a. B-42 to A-51 | g. B-70 to A-30 | l. C-81 to A-30 |
| b. B-46 to A-30 | f. B-54 to A-32 | i. C-75 to A-32 |
| c. B-46 to C-30 | h. B-58 to C-75 | k. -73 to A-30 |
| d. B-48 to B-70 | h. C-61 to B-54 | l. A-51 to C-39 |

F. C. NO. 2 TO AN/FPN-60(V)/AN/FPN-60A(V) Figure 7.31. Pulse Generator Wiring Diagram 7.6317.64

PART LOCATION INDEX

REF. DESIG.	LOCATION	REF. DESIG.	LOCATION	REF. DESIG.
C1	5B	C56	3D	R30
C2	5B	C57	4C	R31
C3	6B	C58	4D	R32
C4	5B	C59	4C	R33
C5	6B	C60	4D	R34
C6	2C	C61	3D	R35
C7	6C			R36
C8	7C	CR1	NOT USED	R37
C9	4B	CR2	7D	R38
C10	5B	CR3	NOT USED	R39
C11	4B	CR4	2D	R40
C12	6E	CR5	2D	R41
C13	7E	CR6	3E	R42
C14	2C	CR7	7D	R43
C15	3D	CR8	2E	R44
C16	3D	CR9	2E	R45
C17	5E	CR10	2E	R46
C18	6C		7D	R47
C19	5C	L1	4C	R48
C20	3B	L2	4D	R49
C21	3B			R50
C22	3A	Q1	2D	R51
C23	3B	Q2	2D	R52
C24	3B	Q3	6C	R53
C25	6B			R54
C26	4B	R1	5B	R55
C27	1C	R2	4B	R56
C28	2C	R3	2C,2D	R57
C29	1C	R4	2C	R58
C30	2D	R5	2C	R59
C31	6C	R6	6C	
C32	6C	R7	7D	TP1
C33	5C	R8	4B	TP2
C34	5D	R9	4B	TP3
C35	1D	R10	4B	
C36	5E	R11	4B	U1
C37	6B	R12	6C	U2
C38	3A	R13	4C	U3
C39	3E	R14	4D	U4
C40	1D	R15	1C	U5
C41	5E	R16	2C	U6
C42	5E	R17	2C	U7
C43	4C	R18	4B	U8
C44	4C	R19	3B	U9
C45	4D	R20	3B	U10
C46	4D	R21	4B	U11
C47	4E	R22	1C	U12
C48	3A	R23	2C	U13
C49	3A	R24	2D	U14
C50	3A	R25	2C	U15
C51	2E	R26	5C	U16
C52	5E	R27	5C	U17
C53	4E	R28	5D	U18
C54	3A	R29	4B	U19
C55	2E			



A

B

C

D

E

PSYN Module

7.65/7.66

AL DETECTOR

NO TRANSDUCER
DRIVE

11' OPT

1.022,
NO ZETA
DRIVE

10.021,
ZETA
DRIVE

REF. DESIG.	LOCATION	RE
C1	1B	
C2	1B	
C3	1B	
C4	1B	
C5	2B	
C6	3A	
C7	5A	
C8	6A	
C9	2B	
C10	2B	
C11	2B	
C12	4B	
C13	4C	
C14	4B	
C15	5B	
C16	5C	
C17	2D	
C18	6C	
C19	6B	
C20	1C	
C21	1C	
C22	1D	
C23	2C	
C24	2C	
C25	2C	
C26	2C	
C27	3C	
C28	4C	
C29	NOT USED	
C30	3C	
C31	5C	
C32	6C	
C33	7C	
C34	7D	
C35	3D	
C36	5C	
C37	2D	
C38	2D	
C39	2D	
C40	3D	
C41	4D	
C42	4D	
C43	5D	
C44	6D	
C45	6D	
C46	7D	
C47	1D	
C48	1D	
C49	1E	
C50	2D	
C51	5D	
C52	1E	
C53	1E	
C54	2E	
C55	5E	
C56	5E	

ART LOCATION INDEX

F. DESIG.	LOCATION	REF. DESIG.	LOCATION
C57	5E	R30	5C
C58	6E	R31	5C
C59	7E	R32	5C
C60	7E	R33	5B
C61	5D	R34	7C
		R35	7C
		R36	3C
CR1	NOT USED	R37	2D
CR2	7B	R38	3D
CR3	NOT USED	R39	3D
CR4	5D	R40	7D
CR5	2D	R41	7D
CR6	3D	R42	5D
CR7	5D	R43	5D
CR8	5E	R44	5D
CR9	5E	R45	2E
CR10	3E	R46	2E
		R47	2E
E1	1A	R48	3E
E2	7A	R49	4E
L1	6E	R50	4E
L2	6E	R51	4E
O1	4E	R52	4E
O2	4E	R53	4D
O3	5B	R54	1D
		R55	5D
		R56	5C
R1	2B	R57	6B
R2	3A	R58	5B
R3	3A	R59	5D
R4	3B		
R5	4A	TP1	6A
R6	6B	TP2	6A
R7	7B	TP3	3A
R8	2B	TP4	2A
R9	2B		
R10	2B	U1	2B
R11	2B	U2	2B
R12	5B	U3	4B
R13	7B	U4	6B
R14	7B	U5	5B
R15	3B	U6	6B
R16	4B	U7	3B
R17	4B	U8	3C
R18	1C	U9	1C
R19	1C	U10	2C
R20	2C	U11	3C
R21	2C	U12	4C
R22	3C	U13	5C
R23	4C	U14	6C
R24	4C	U15	1D
R25	4C	U16	3D
R26	6B	U17	6D
R27	7C	U18	6D
R28	7C	U19	1E
R29	2C		

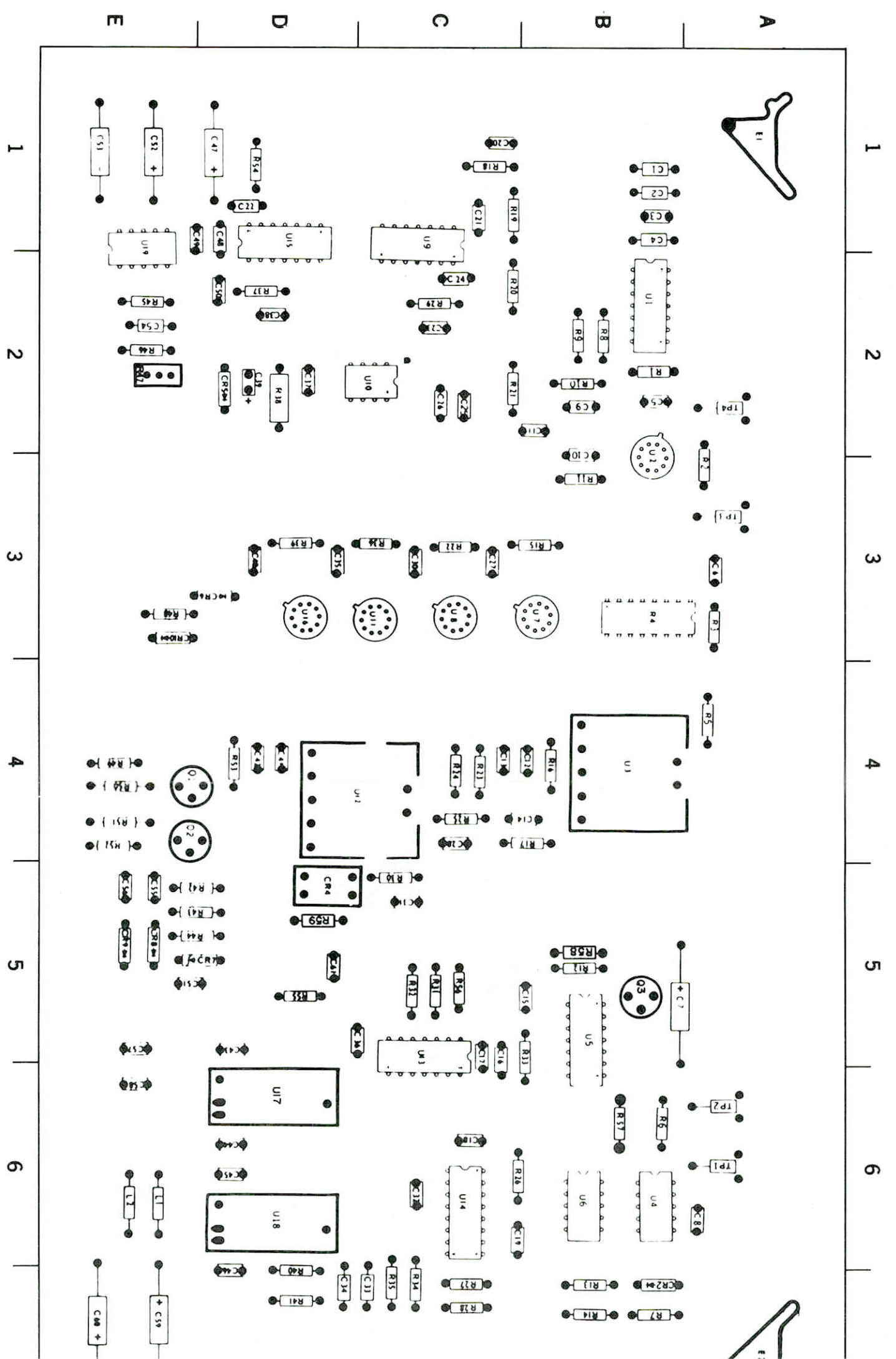


Figure 7.33. W06: Parts

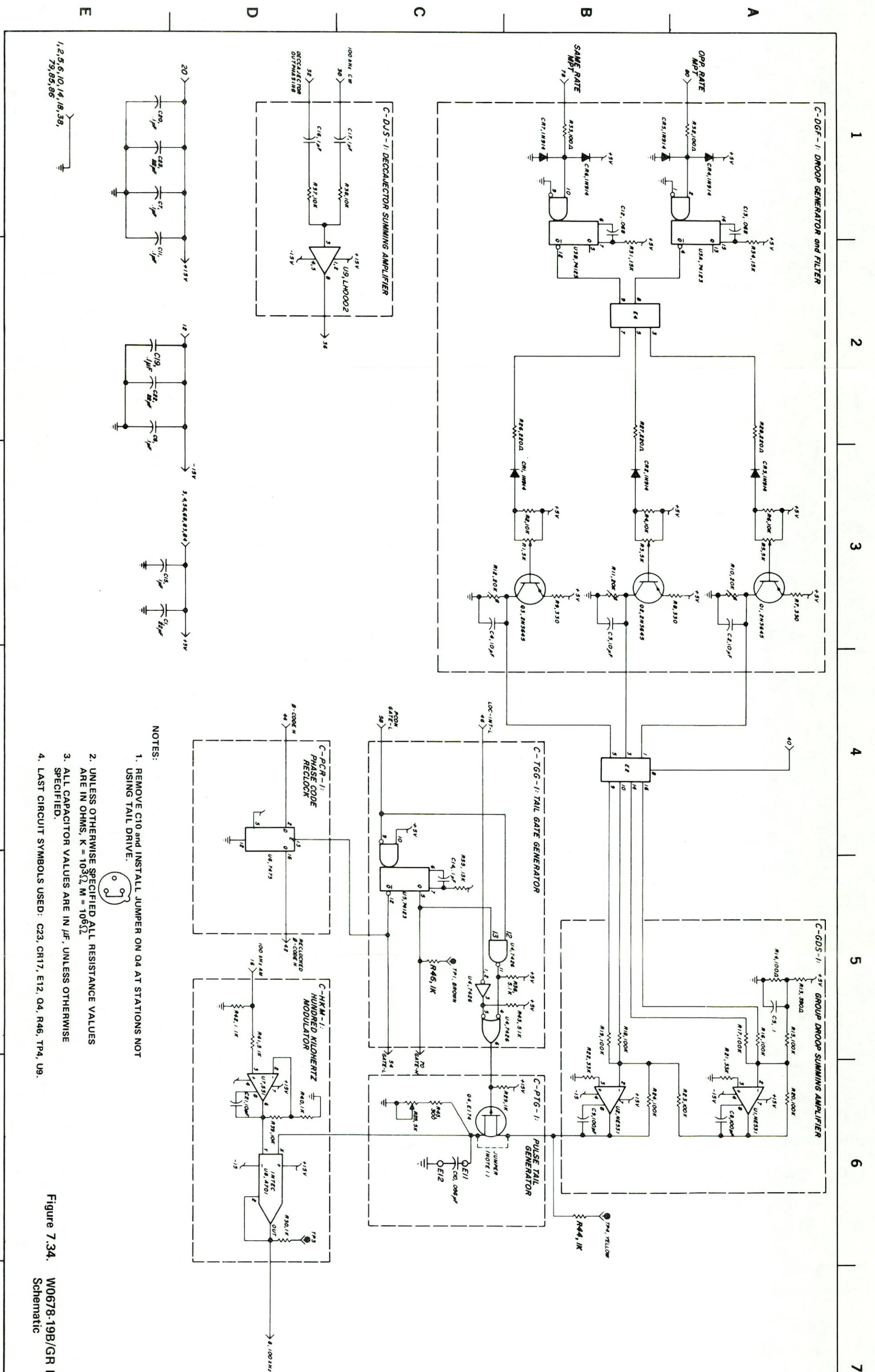


78-1/PSYN Module
Locator

7.67/7.68

PART LOCATION INDEX

REF. DESIG.	LOCATION	REF. DESIG.	LOCATION
C1	3E	R1	3B
C2	3A	R2	3B
C3	3B	R3	3B
C4	3C	R4	3B
C5	5A	R5	3A
C6	2E	R6	3A
C7	1E	R7	3A
C8	6A	R8	3A
C9	6B	R9	3B
C10	6C	R10	3A
C11	2E	R11	3B
C12	1B	R12	3C
C13	1A	R13	5A
C14	5C	R14	5A
C15	3E	R15	5A
C16	1D	R16	5A
C17	1C	R17	5A
C18	NOT USED	R18	5B
C19	2E	R19	5B
C20	1E	R20	6A
C21	6D	R21	6A
C22	2E	R22	6B
C23	1E	R23	6A
CR1	3B	R24	6B
CR2	3B	R25	6C
CR3	3A	R26	2B
CR4	1A	R27	2B
CR5	1B	R28	2A
CR6	1B	R29	6B
CR7	1B	R30	6D
E1	NOT USED	R31	2B
E2	4B	R32	1A
E3	NOT USED	R33	1B
E4	2B	R34	2A
E5	NOT USED	R35	5C
E6	NOT USED	R36	5B
E7	NOT USED	R37	1D
E8	NOT USED	R38	1C
E9	NOT USED	R39	6D
E10	NOT USED	R40	6D
E11	6C	R41	5D
E12	6C	R42	5D
O1	3A	R43	5B
O2	3B	R44	6B
O3	3B	R45	6C
O4	6C	R46	5C
		TP1	5C
		TP2	NOT USED
		TP3	6D
		TP4	6B
		U1	6A
		U2	6B
		U3	1A,1B
		U4	5C
		U5	5C
		U6	4D
		U7	6D
		U8	6D
		U9	2C



- NOTES:
1. REMOVE C10 and INSTALL JUMPER ON Q4 AT STATIONS NOT USING TAIL DRIVE.
 2. UNLESS OTHERWISE SPECIFIED ALL RESISTANCE VALUES ARE IN OHMS, K = $10^3\Omega$, M = $10^6\Omega$.
 3. ALL CAPACITOR VALUES ARE IN μF , UNLESS OTHERWISE SPECIFIED.
 4. LAST CIRCUIT SYMBOLS USED: C23, CR17, ET2, Q4, R46, TP4, U9.

Figure 7.34. W0678-19B/GR DR Schematic

OOOP Module
7.69/7.70

A

B

C

D

E

TAIL

REF. DESIG.	PAR	LOCA
C1	1	1
C2	3	1
C3	4	4
C4	4	4
C5	5	5
C6	5	5
C7	5	5
C8	5	5
C9	5	5
C10	NOT L	NOT L
C11	5	5
C12	2	2
C13	2	2
C14	3	3
C15	3	3
C16	4	4
C17	4	4
C18	5	5
C19	NOT L	NOT L
C20	5	5
C21	5	5
C22	7	7
C23	7	7
CR1	2	2
CR2	2	2
CR3	2	2
CR4	2	2
CR5	1	1
CR6	2	2
CR7	3	3
E1	1	1
E2	4	4
E3	7	7
E4	2	2
E5	NOT L	NOT L
E6	NOT L	NOT L
E7	NOT L	NOT L
E8	NOT L	NOT L
E9	NOT L	NOT L
E10	NOT L	NOT L
E11	6	6
E12	6	6
O1	3	3
O2	3	3
O3	3	3
O4	6	6

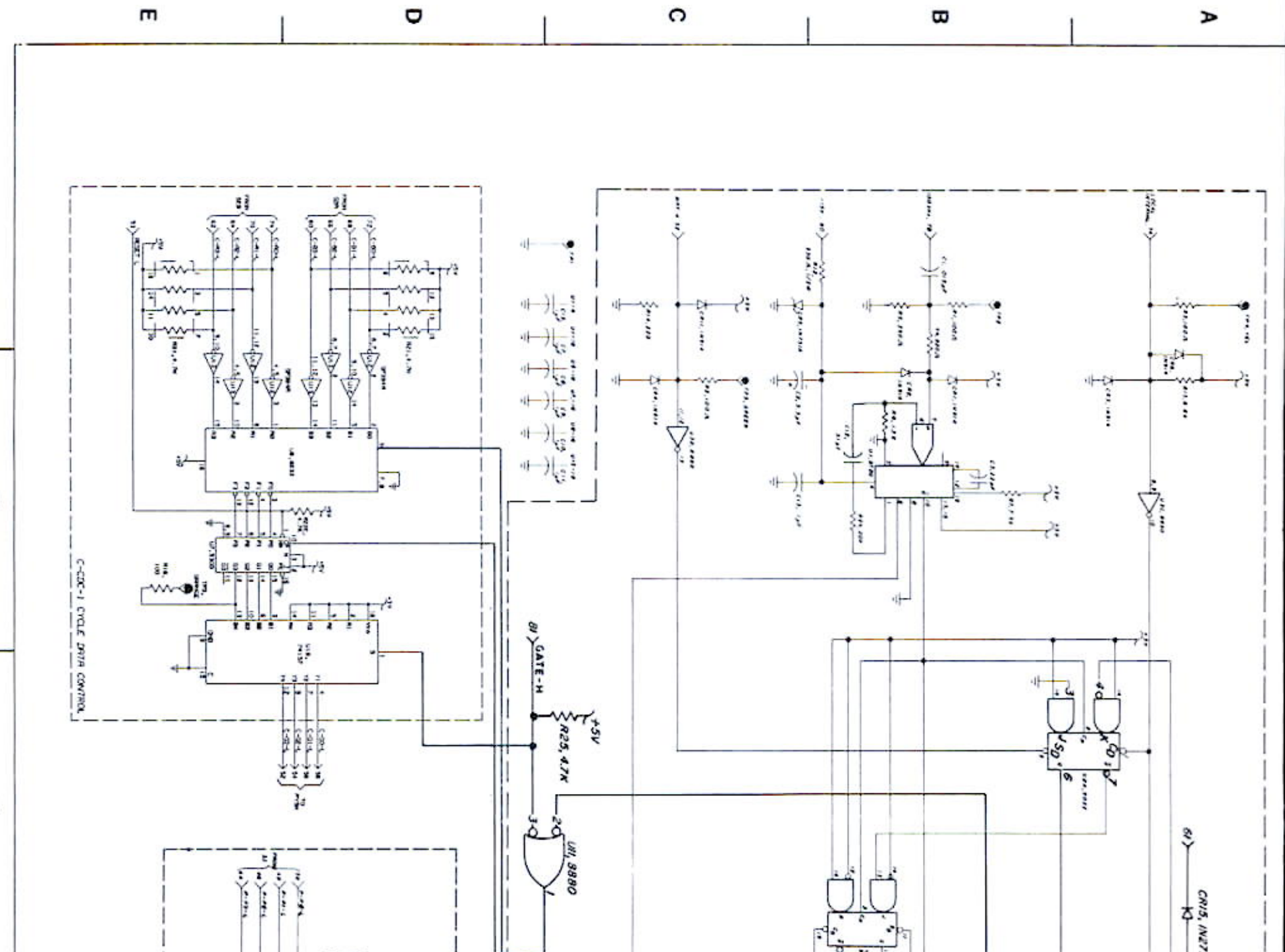


GR DROOP Module

7.7177.72

PART LOCATION INDEX

REF. DESIG.	LOCATION	REF. DESIG.	LOCATION
C1	1B	R15	4E
C2	2C	R16	5D
C3	2B	R17	5D
C4	7C	R18	2E
C5	7B	R19	6C
C6	7C	R20	6C
C7	1C	R21	1D,1E
C8	2C	R22	2D,4D
C9	2C	R23	6C
C10	2C	R24	2B
C11	2C	R25	3C
C12	2B	R26	4A
C13	1C		
CR1	2B	S1	5C
CR2	2B	TP1	1C
CR3	2A	TP2	1B
CR4	2C	TP3	3E
CR5	1C	TP4	1A
CR6	2A	TP5	2C
CR7	6D	TP6	7B
CR8	6D	TP7	4E
CR9	6D	TP8	5C
CR10	6D	TP9	5D
CR11	1C		
CR12	6B	U1	2B
CR13	4A	U2	3A,3B
CR14	3A	U3	2A,2C,4B
CR15	3A	U4	4C,5B,5C
		U5	4C
R1	1B	U6	2D
R2	2C	U7	2E
R3	1A	U8	5B
R4	1B	U9	5B
R5	1B	U10	6D
R6	2B	U11	3C,4B
R7	2B	U12	2E
R8	5C	U13	2D
R9	4C	U14	4D,4E
R10	5D	U15	4E
R11	5D	U16	6B
R12	1B	U17	6B
R13	2A	U18	6C
R14	1C	U19	2E





4

5

6

7

PART L

REF. DESIG.	LOCATIONS
C1	1B
C2	2A
C3	2B
C4	1D
C5	1E
C6	6E
C7	3B
C8	5B
C9	3C
C10	4C
C11	4D
C12	2A
C13	2B
CR1	2B
CR2	2B
CR3	3C
CR4	4C
CR5	1B
CR6	3C
CR7	6B
CR8	7B
CR9	6B
CR10	7B
CR11	4B
CR12	5E
CR13	5E
CR14	3E
CR15	3E
R1	1B
R2	3B
R3	4B
R4	1B
R5	1B
R6	2B
R7	3B
R8	4A
R9	4B
R10	6B
R11	7B
R12	1B
R13	3C
R14	4C

LOCATION INDEX		
DN	REF. DESIG.	LOCATION
R15	R15	5C
R16	R16	6C
R17	R17	7C
R18	R18	2C
R19	R19	6D
R20	R20	6D
R21	R21	2D
R22	R22	4D
R23	R23	6E
R24	R24	2A
R25	R25	1E
R26	R26	2D
S1	S1	5B
TP1	TP1	1A
TP2	TP2	2A
TP3	TP3	2A
TP4	TP4	3A
TP5	TP5	3A
TP6	TP6	4A
TP7	TP7	5A
TP8	TP8	6A
TP9	TP9	6A
U1	U1	2B
U2	U2	3B
U3	U3	4B
U4	U4	4B
U5	U5	5B
U6	U6	2C
U7	U7	2C
U8	U8	4C
U9	U9	5C
U10	U10	6C
U11	U11	1D
U12	U12	2D
U13	U13	2D
U14	U14	3D
U15	U15	4D
U16	U16	5C
U17	U17	5D
U18	U18	6D

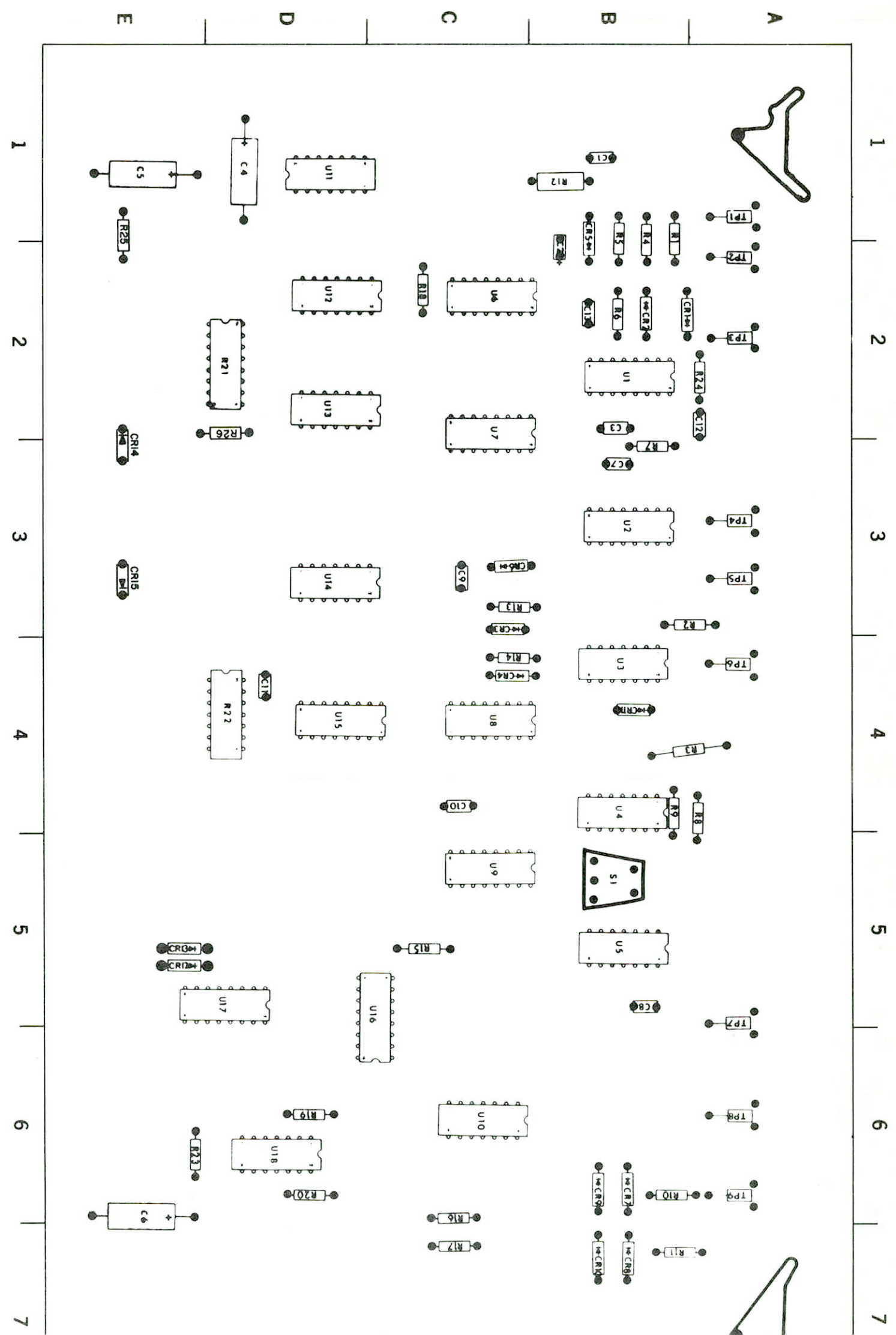
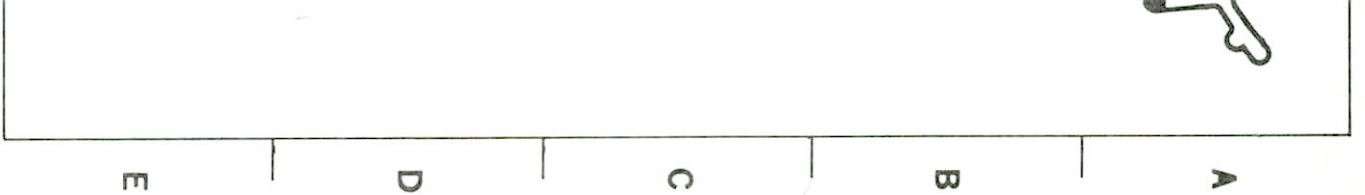
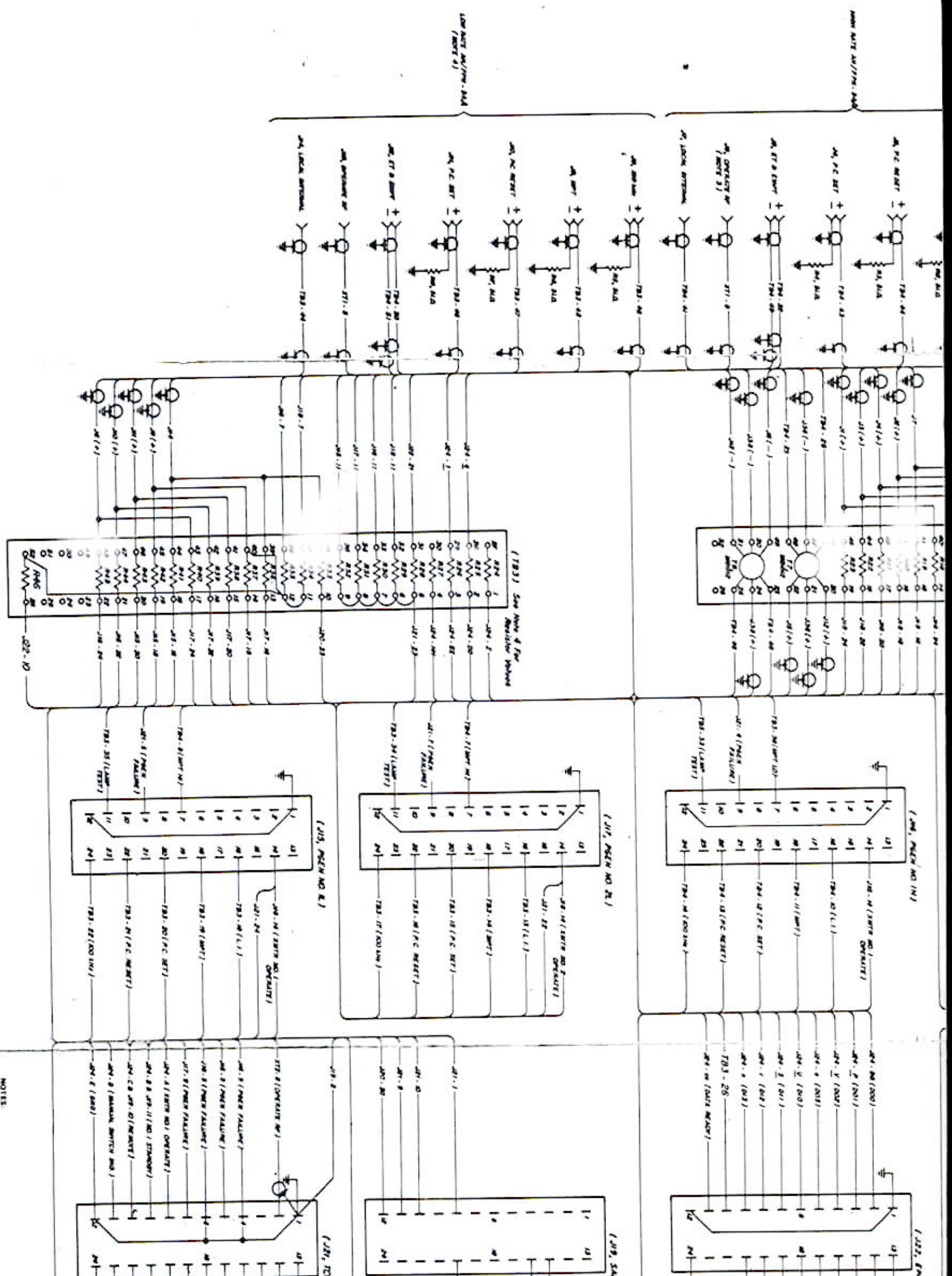


Figure 7.37. W0677 Parts

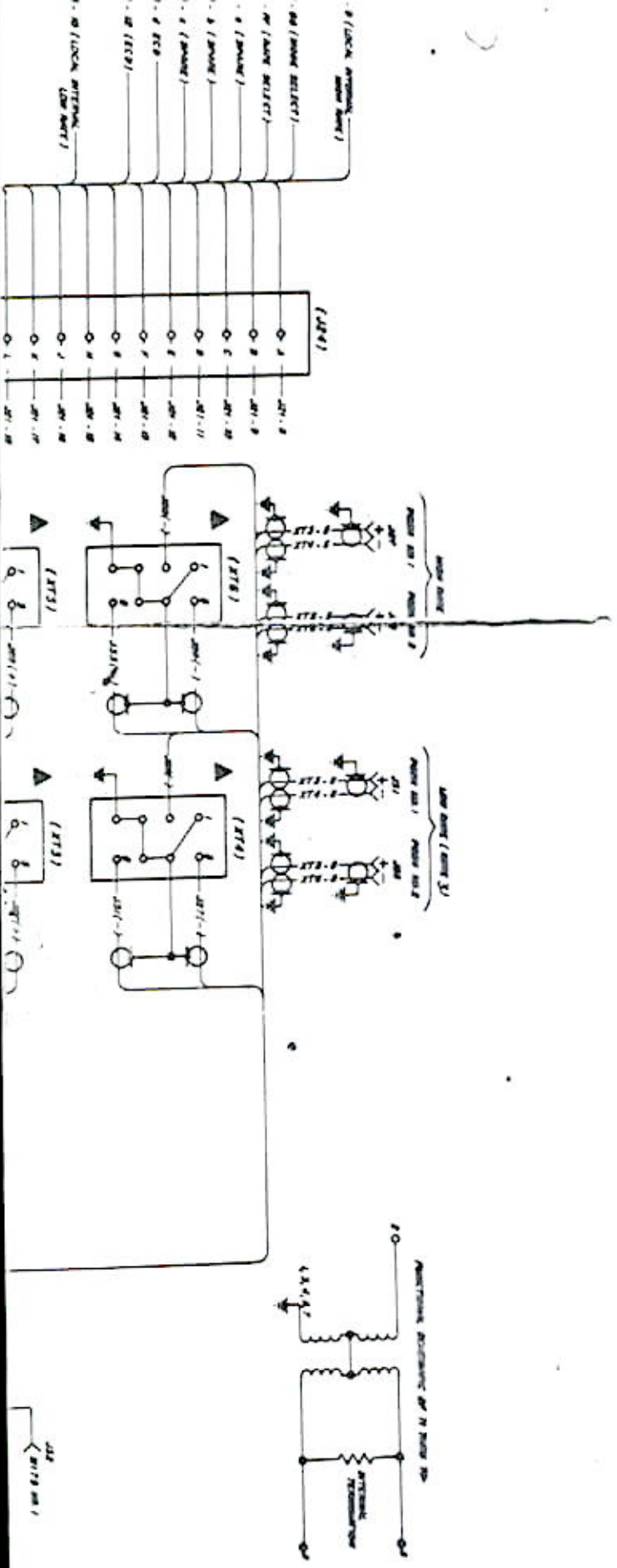


3-2/PCON Module
Locator

7.75/7.76



- NOTES
1. FOR DUAL RATE OPERATION, REMOVE X 2311 TO 2314 AND 2317 TO 2318.
 2. FOR SINGLE RATE OPERATION, TERMINATE X 2311 TO 2314 AND 2317 TO 2318.
 3. AT SINGLE RATE STATIONS USE LOW RATE RATES.
 4. R110 AND R227 - VILL.
 5. R11, 12, 13, 14, 15, 16, 17, 18, 19, 20, 21, 22, 23, 24, 25, 26, 27, 28, 29, 30, 31, 32, 33, 34, 35, 36, 37, 38, 39, 40, 41, 42, 43, 44, 45, 46, 47, 48, 49, 50, 51, 52, 53, 54, 55, 56, 57, 58, 59, 60, 61, 62, 63, 64, 65, 66, 67, 68, 69, 70, 71, 72, 73, 74, 75, 76, 77, 78, 79, 80, 81, 82, 83, 84, 85, 86, 87, 88, 89, 90, 91, 92, 93, 94, 95, 96, 97, 98, 99, 100, 101, 102, 103, 104, 105, 106, 107, 108, 109, 110, 111, 112, 113, 114, 115, 116, 117, 118, 119, 120, 121, 122, 123, 124, 125, 126, 127, 128, 129, 130, 131, 132, 133, 134, 135, 136, 137, 138, 139, 140, 141, 142, 143, 144, 145, 146, 147, 148, 149, 150, 151, 152, 153, 154, 155, 156, 157, 158, 159, 160, 161, 162, 163, 164, 165, 166, 167, 168, 169, 170, 171, 172, 173, 174, 175, 176, 177, 178, 179, 180, 181, 182, 183, 184, 185, 186, 187, 188, 189, 190, 191, 192, 193, 194, 195, 196, 197, 198, 199, 200, 201, 202, 203, 204, 205, 206, 207, 208, 209, 210, 211, 212, 213, 214, 215, 216, 217, 218, 219, 220, 221, 222, 223, 224, 225, 226, 227, 228, 229, 230, 231, 232, 233, 234, 235, 236, 237, 238, 239, 240, 241, 242, 243, 244, 245, 246, 247, 248, 249, 250, 251, 252, 253, 254, 255, 256, 257, 258, 259, 260, 261, 262, 263, 264, 265, 266, 267, 268, 269, 270, 271, 272, 273, 274, 275, 276, 277, 278, 279, 280, 281, 282, 283, 284, 285, 286, 287, 288, 289, 290, 291, 292, 293, 294, 295, 296, 297, 298, 299, 300, 301, 302, 303, 304, 305, 306, 307, 308, 309, 310, 311, 312, 313, 314, 315, 316, 317, 318, 319, 320, 321, 322, 323, 324, 325, 326, 327, 328, 329, 330, 331, 332, 333, 334, 335, 336, 337, 338, 339, 340, 341, 342, 343, 344, 345, 346, 347, 348, 349, 350, 351, 352, 353, 354, 355, 356, 357, 358, 359, 360, 361, 362, 363, 364, 365, 366, 367, 368, 369, 370, 371, 372, 373, 374, 375, 376, 377, 378, 379, 380, 381, 382, 383, 384, 385, 386, 387, 388, 389, 390, 391, 392, 393, 394, 395, 396, 397, 398, 399, 400, 401, 402, 403, 404, 405, 406, 407, 408, 409, 410, 411, 412, 413, 414, 415, 416, 417, 418, 419, 420, 421, 422, 423, 424, 425, 426, 427, 428, 429, 430, 431, 432, 433, 434, 435, 436, 437, 438, 439, 440, 441, 442, 443, 444, 445, 446, 447, 448, 449, 450, 451, 452, 453, 454, 455, 456, 457, 458, 459, 460, 461, 462, 463, 464, 465, 466, 467, 468, 469, 470, 471, 472, 473, 474, 475, 476, 477, 478, 479, 480, 481, 482, 483, 484, 485, 486, 487, 488, 489, 490, 491, 492, 493, 494, 495, 496, 497, 498, 499, 500, 501, 502, 503, 504, 505, 506, 507, 508, 509, 510, 511, 512, 513, 514, 515, 516, 517, 518, 519, 520, 521, 522, 523, 524, 525, 526, 527, 528, 529, 530, 531, 532, 533, 534, 535, 536, 537, 538, 539, 540, 541, 542, 543, 544, 545, 546, 547, 548, 549, 550, 551, 552, 553, 554, 555, 556, 557, 558, 559, 560, 561, 562, 563, 564, 565, 566, 567, 568, 569, 570, 571, 572, 573, 574, 575, 576, 577, 578, 579, 580, 581, 582, 583, 584, 585, 586, 587, 588, 589, 590, 591, 592, 593, 594, 595, 596, 597, 598, 599, 600, 601, 602, 603, 604, 605, 606, 607, 608, 609, 610, 611, 612, 613, 614, 615, 616, 617, 618, 619, 620, 621, 622, 623, 624, 625, 626, 627, 628, 629, 630, 631, 632, 633, 634, 635, 636, 637, 638, 639, 640, 641, 642, 643, 644, 645, 646, 647, 648, 649, 650, 651, 652, 653, 654, 655, 656, 657, 658, 659, 660, 661, 662, 663, 664, 665, 666, 667, 668, 669, 670, 671, 672, 673, 674, 675, 676, 677, 678, 679, 680, 681, 682, 683, 684, 685, 686, 687, 688, 689, 690, 691, 692, 693, 694, 695, 696, 697, 698, 699, 700, 701, 702, 703, 704, 705, 706, 707, 708, 709, 710, 711, 712, 713, 714, 715, 716, 717, 718, 719, 720, 721, 722, 723, 724, 725, 726, 727, 728, 729, 730, 731, 732, 733, 734, 735, 736, 737, 738, 739, 740, 741, 742, 743, 744, 745, 746, 747, 748, 749, 750, 751, 752, 753, 754, 755, 756, 757, 758, 759, 760, 761, 762, 763, 764, 765, 766, 767, 768, 769, 770, 771, 772, 773, 774, 775, 776, 777, 778, 779, 780, 781, 782, 783, 784, 785, 786, 787, 788, 789, 790, 791, 792, 793, 794, 795, 796, 797, 798, 799, 800, 801, 802, 803, 804, 805, 806, 807, 808, 809, 810, 811, 812, 813, 814, 815, 816, 817, 818, 819, 820, 821, 822, 823, 824, 825, 826, 827, 828, 829, 830, 831, 832, 833, 834, 835, 836, 837, 838, 839, 840, 841, 842, 843, 844, 845, 846, 847, 848, 849, 850, 851, 852, 853, 854, 855, 856, 857, 858, 859, 860, 861, 862, 863, 864, 865, 866, 867, 868, 869, 870, 871, 872, 873, 874, 875, 876, 877, 878, 879, 880, 881, 882, 883, 884, 885, 886, 887, 888, 889, 890, 891, 892, 893, 894, 895, 896, 897, 898, 899, 900, 901, 902, 903, 904, 905, 906, 907, 908, 909, 910, 911, 912, 913, 914, 915, 916, 917, 918, 919, 920, 921, 922, 923, 924, 925, 926, 927, 928, 929, 930, 931, 932, 933, 934, 935, 936, 937, 938, 939, 940, 941, 942, 943, 944, 945, 946, 947, 948, 949, 950, 951, 952, 953, 954, 955, 956, 957, 958, 959, 960, 961, 962, 963, 964, 965, 966, 967, 968, 969, 970, 971, 972, 973, 974, 975, 976, 977, 978, 979, 980, 981, 982, 983, 984, 985, 986, 987, 988, 989, 990, 991, 992, 993, 994, 995, 996, 997, 998, 999, 1000.
 6. FOR USE WITH THE AN/PW-26 TRANSMITTERS TO TRS12, TRS14 TO TRS17.
 7. FOR USE WITH THE AN/PW-44 TRANSMITTERS TO TRS12, TRS14 TO TRS17.



APPENDIX A

TCE/TRANSMITTER DIAGRAMS AND SCHEMATICS

A.1 Introduction. The fifteen diagrams and schematics in the appendix contain changes that have been made to various portions of the transmitters (AN/FPN-39/42/44) during the installation of the LORAN Replacement Equipment. Additional information for the AN/FPN-42 Loran Transmitting Set including parts list can be found in the Technical Manual for the AN/FPN-42 Loran Transmitting Set (CG7610-01-GEO-4701).



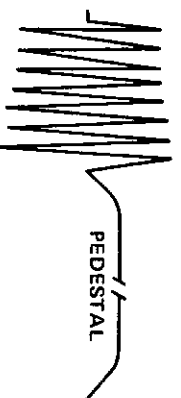
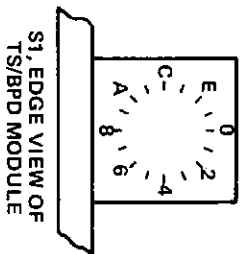
TRIGGER SPLITTER/BIAS PEDESTAL DRIVE (TS/BPD) MODULE CONTROLS

DESCRIPTION:

S1 IS A 16 POSITION, SCREW DRIVER AD ROTARY SWITCH MOUNTED ON THE TS/ MODULE USED TO CONTROL THE POSIT OF THE BIAS PEDESTAL WITH RESPECT THE RF DRIVE WAVEFORM.

PROCEDURE:

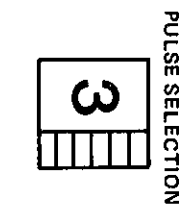
- a. OBSERVE TP4; ADJUST S1 UNTIL THE ILLATOR WAVEFORM IS 100 μ s (\pm 5 μ s) L EACH INCREMENT OF S1 WILL CHANGE OSCILLATOR WAVEFORM 10 μ s (\pm 2 μ s).
- b. OBSERVE THE RIGHT/LEFT 2nd IPA IN WAVEFORM; THE BIAS PEDESTAL SHOU BEGIN AFTER THE END OF RF DRIVE W FORM. IF NOT, INCREASE S1 (INCREME CW DIRECTION).



RIGHT/LEFT 2nd IPA INPUT

MODE
A
B
NORMAL

MODE:
A THREE POSITION WAFER SWITCH SEL A TRIGGER EVERY INTERVAL (NORMA EVERY OTHER INTERVAL (A or B)).



PULSE SELECTION:
A 10-POSITION THUMBWHEEL SWITCH SELS THE SCOPE TRIGGER.
0 = EARLY TRIGGER
1 thru 9 = RESPECTIVE MULTIPULSE

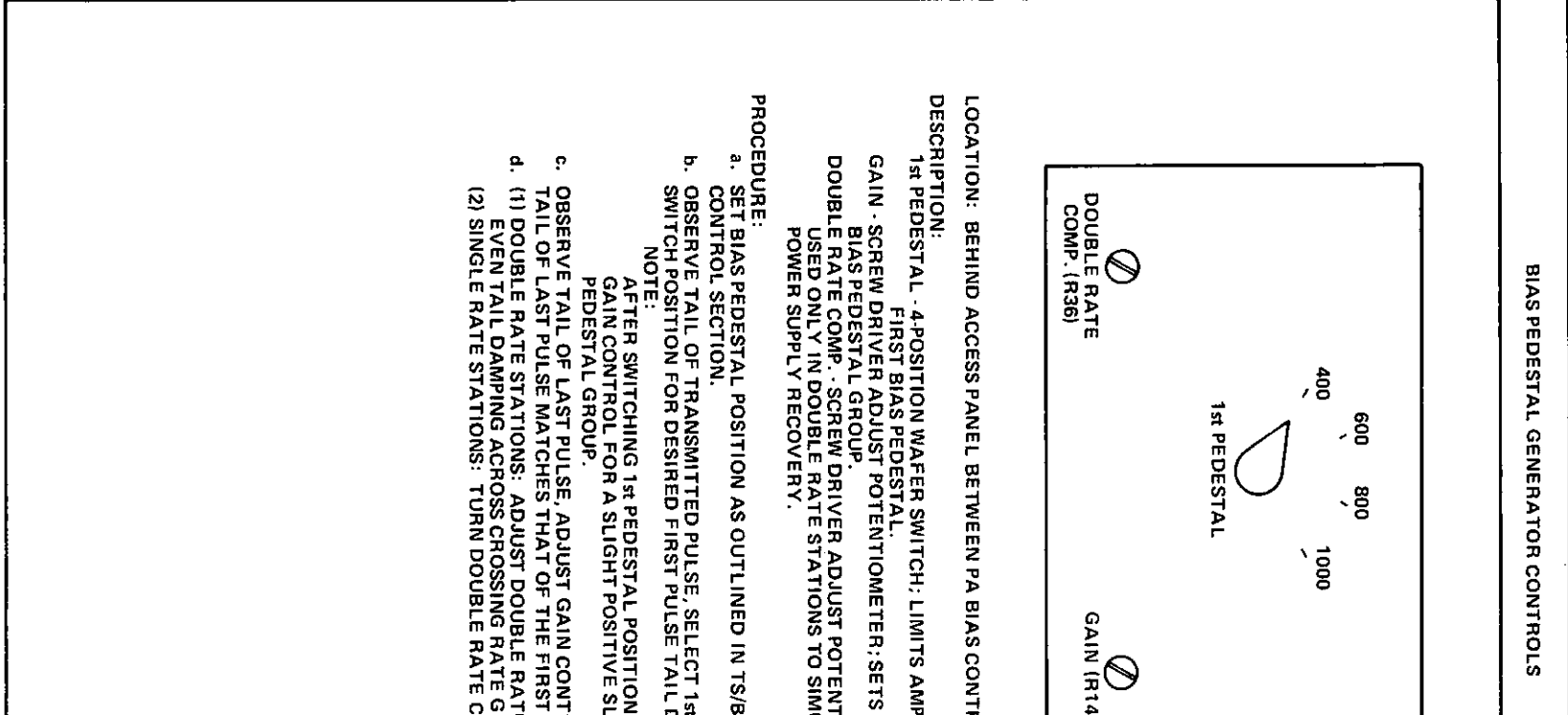
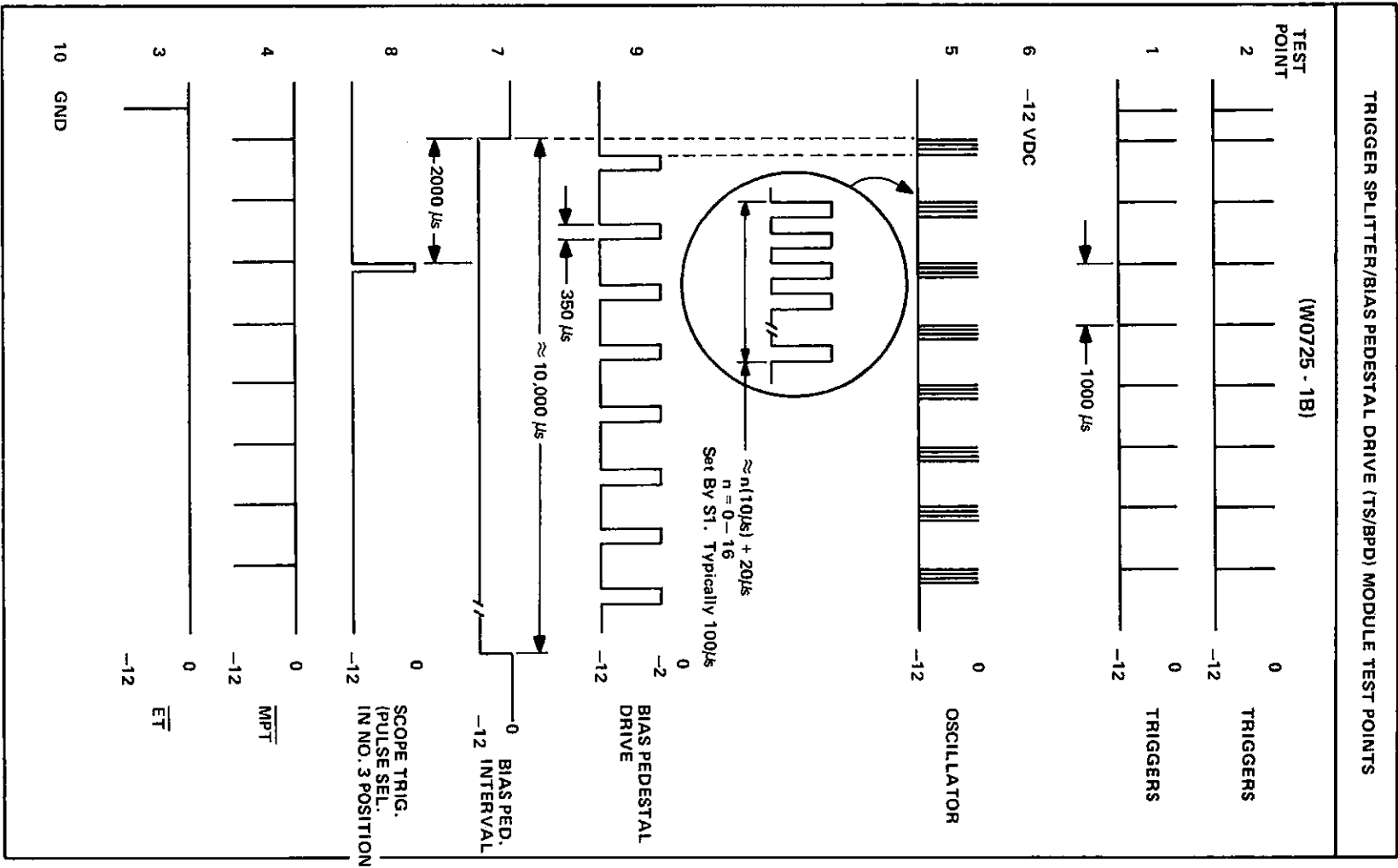
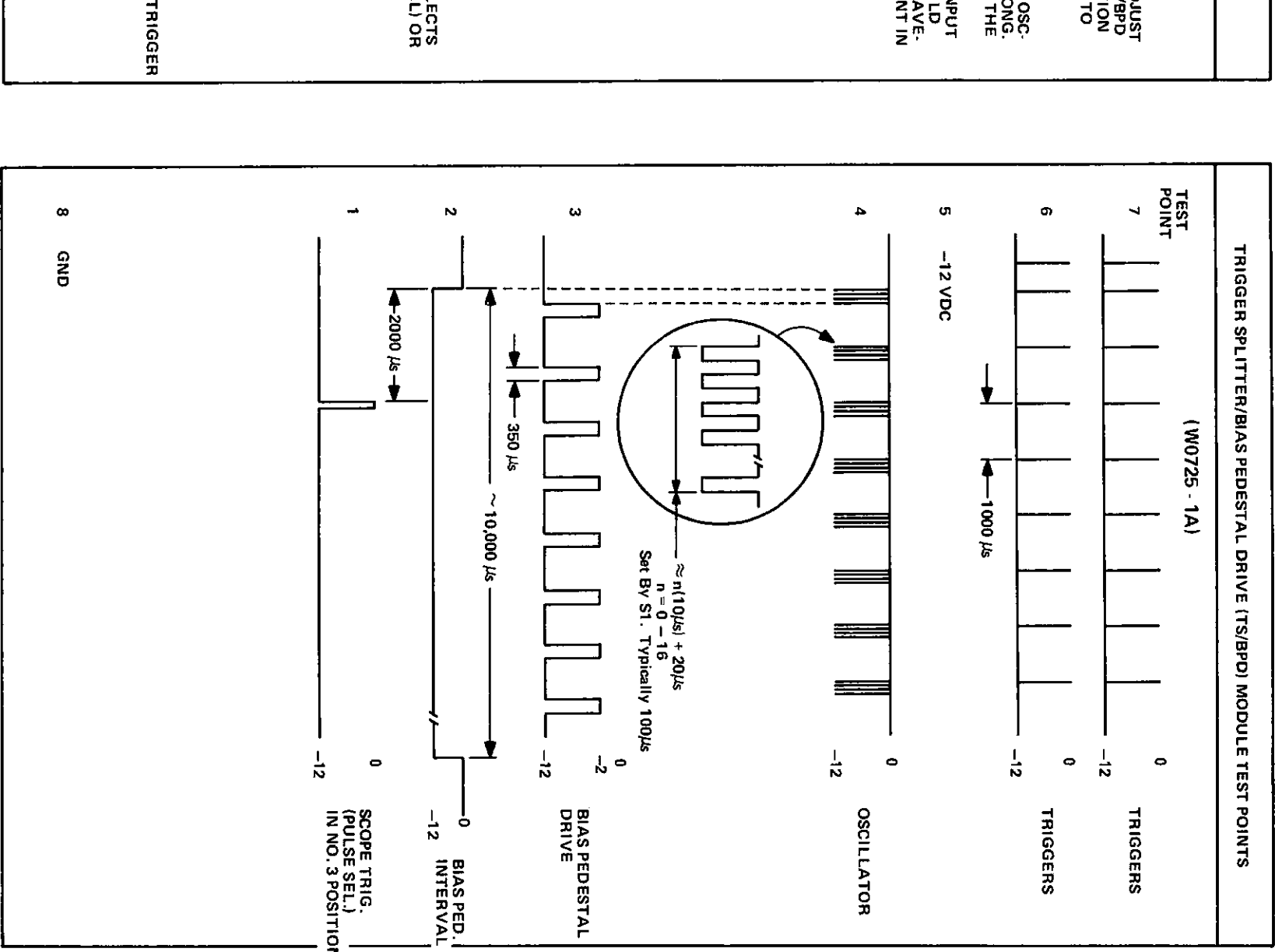


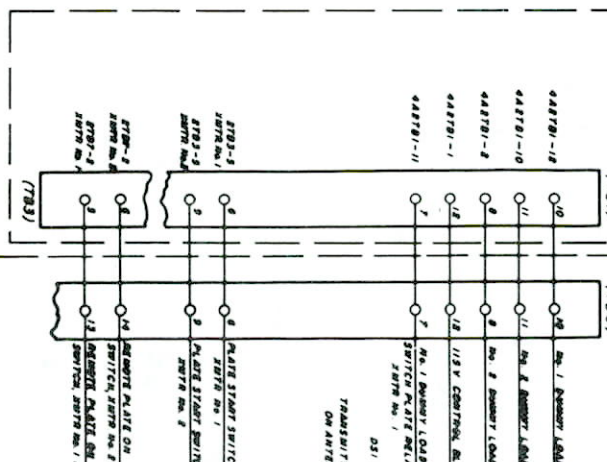
Figure A.1. Transmitter Selector/Bias Pedestal and Bias Pedestal Generator Controls

ROLS.
LITUDE OF
SLOPE OF
IOMETER;
LATE HV
PD MODULE
PEDESTAL
DAMPING.
S ADJUST
OPE IN THE
ROL UNTIL
PULSE.
E COMP FOR
ROUP.
OMP FULL ccw.

pedestal Drive
enerator Operating

A.3/A.4

POWER DISTRIBUTION BOX (4A3)



LOCAL CONTROL PANEL





Power Distribution
LRE/AN/FPN-39

A.5/A.6

PART LOCATION INDEX	
REF. DESIG.	LOCATION
C1	2C
C2	2D
C3	3C
C4	3D
C5	5C
C6	6B
C7	6D
C8	6B
C9	6B
C10	6C
C11	2A
C12	1B
C13	4D
J1	1C
J2	1E
J3	2F
J4	7C
J5	7C
J6	7B
J7	7B
L1	2A
R1	2C
R2	2D
R3	2C
R4	2D
R5	3C
R6	3C
R7	3C
R8	3C
R9	3D
R10	4C
R11	4D
R12	4C
R13	4C
R14	4D
R15	5B
R16	5B
R17	5D
R18	5D
R19	5C
R20	5C
R21	5D
R22	5D
R23	7B
R24	7C
R25	7C
R26	7C
R27	7B
R28	7B
R29	7C
R30	7D
R31	2E
R32	2F
T1	2C
T2	2E
T3	6C
TB1	1A
V1	3C
V2	5D
V3	5C

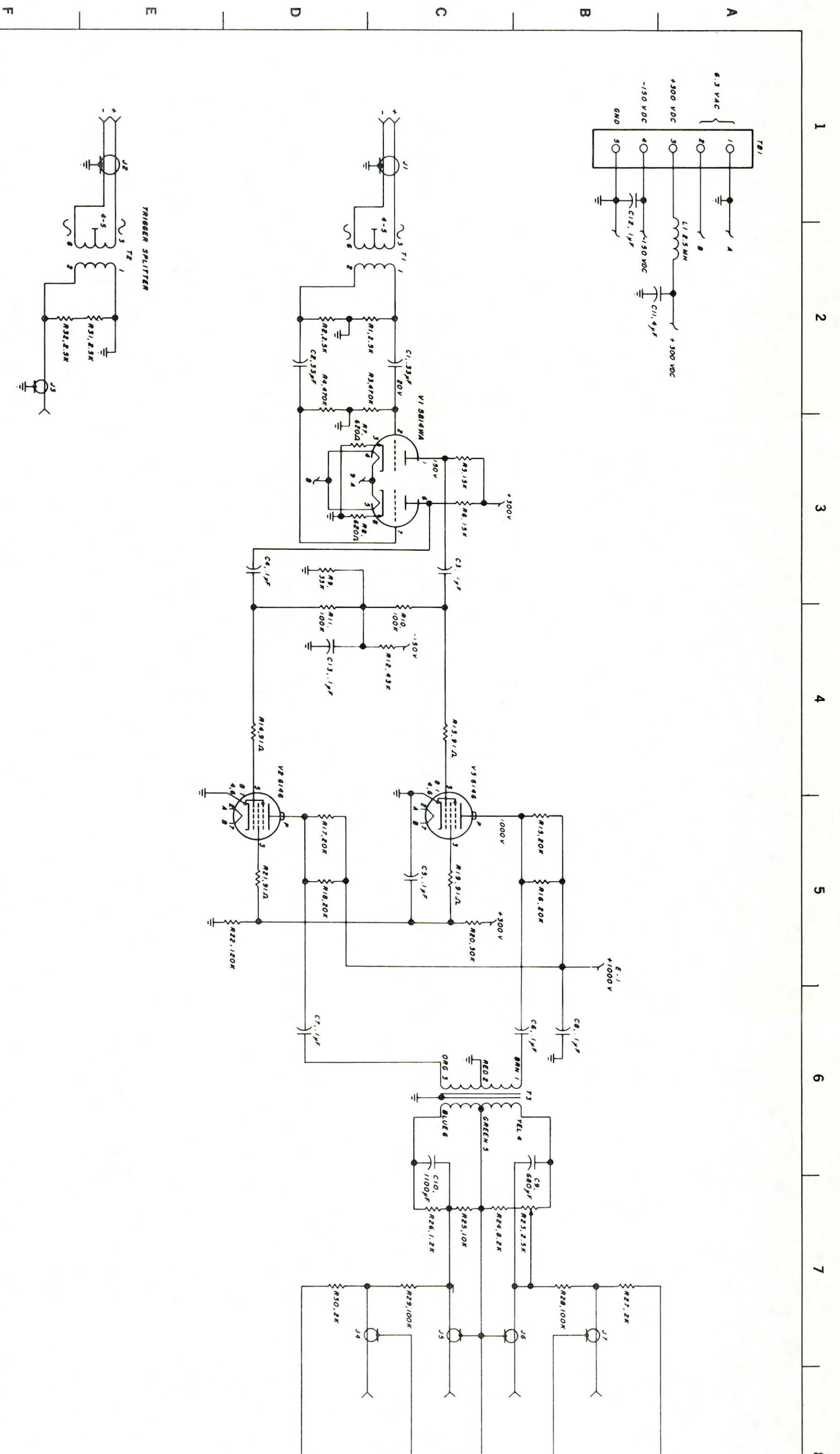


Figure A.3. AN/FPN-39 LRE RF Amplifier (N)

8



A

3

B

3

C

3

D

3

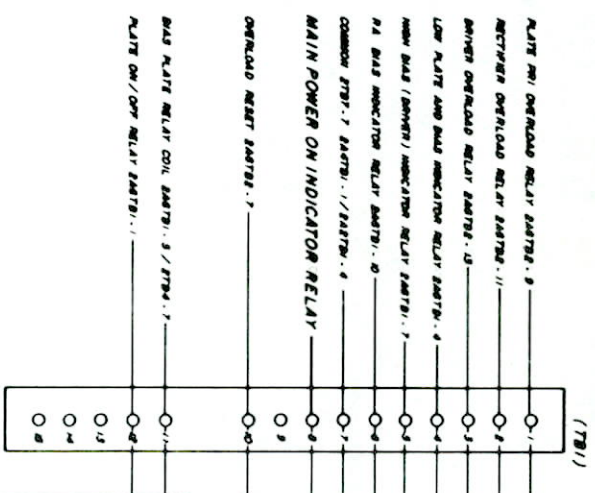
E

3

F

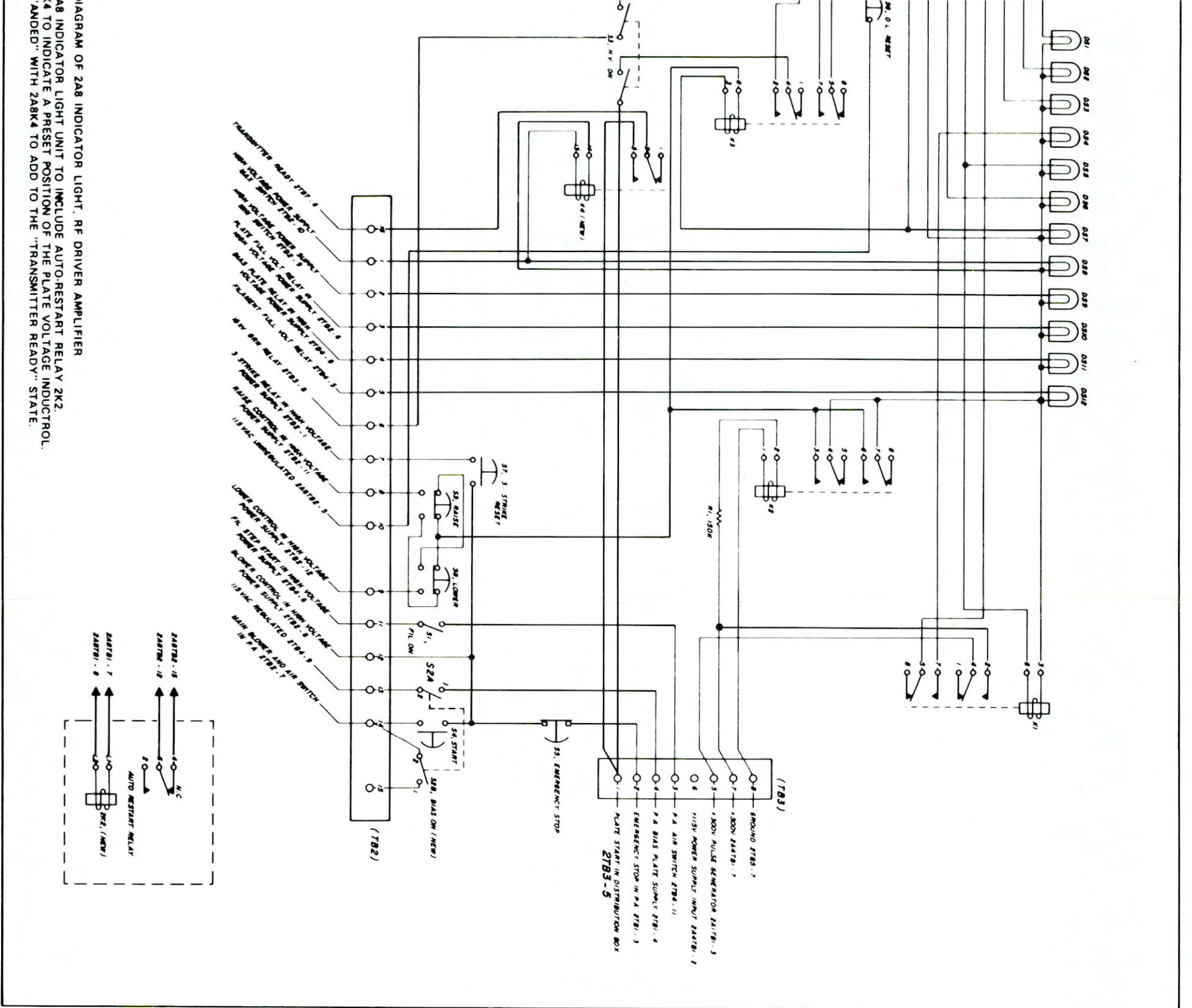
Jew UD 2A1)
A.7/A.8

3



- NOTES:
1. PREFIX ALL CIRCUIT SYMBOLS WITH ZAB
 2. ALL HEAVY LINES ARE MODIFICATIONS

SCHMATIC D
 REWIRING OF UD2
 ADDITION OF ZAB
 THE "H.V. ON" IS



INDICATOR LIGHT UNIT TO INCLUDE AUTO-RESTART RELAY 2K2.
 4 TO INDICATE A PRESET POSITION OF THE PLATE VOLTAGE INDICATOR.
 "AND" WITH 2A8K4 TO ADD TO THE "TRANSMITTER READY" STATE.

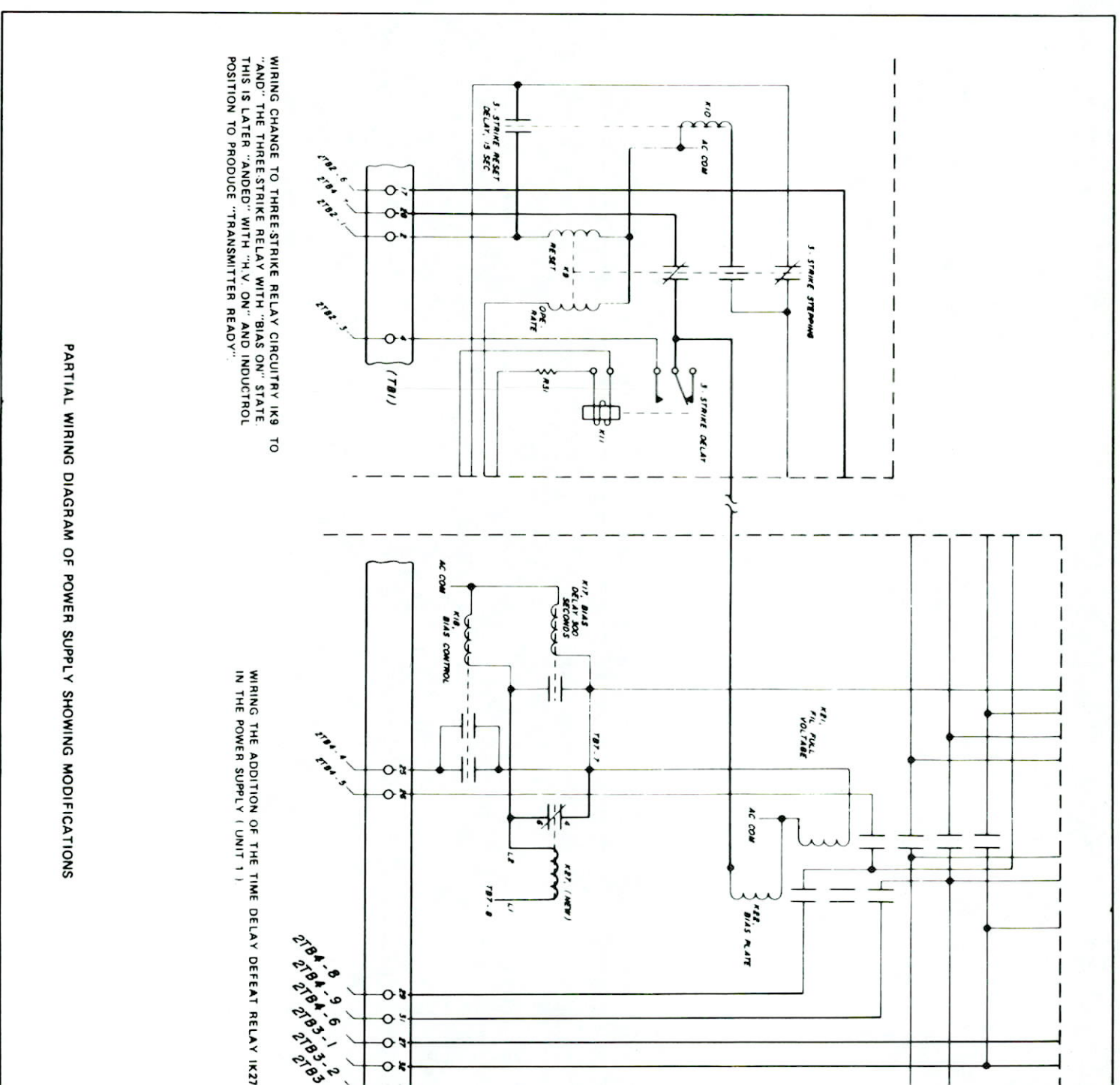
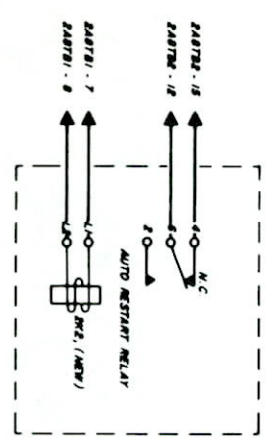
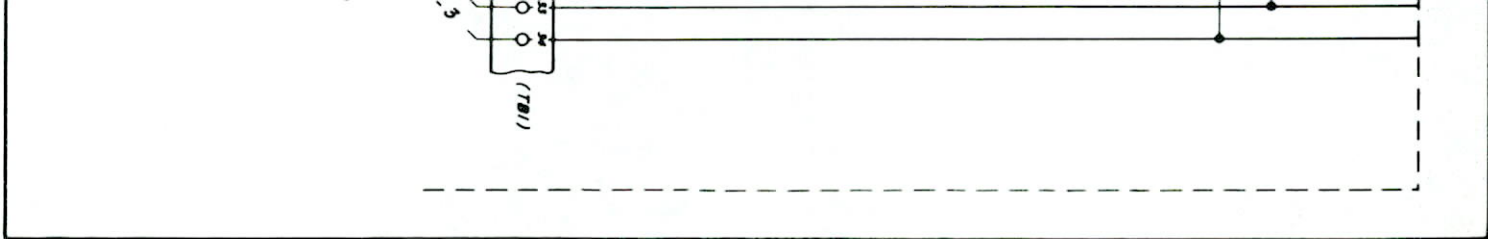


Figure A.4. Transmitter Wi
 Installation Of



ring Changes For
LRE/AN/FPN-39

A.9/A.10

PART LOCATION INDEX

REF. DESIG.	LOCATION
DS4	2C
DS5	2C
DS6	3C
DS10	4C
DS11	1E
DS12	1E
DS13	4D
DS14	6C
DS15	BD
DS23	2C
F4	1E
F5	1E
K1	3E
K2	4C
K7	BD
K25	7D
K26	7D
K27	6C
K28	2C
K29	2C
K30	2C
K31	3C
K32	3C
K33	4C
K34	5D
K39	2E
K40	4E
M19	3D
R19	7D
R21	8D
R23	7D
S2	3E & 5C
S3	5B & 6E
S4	3C
S6	6E
S7	2B
S8	3C
S14	6C
S16C	5E
T83	1A

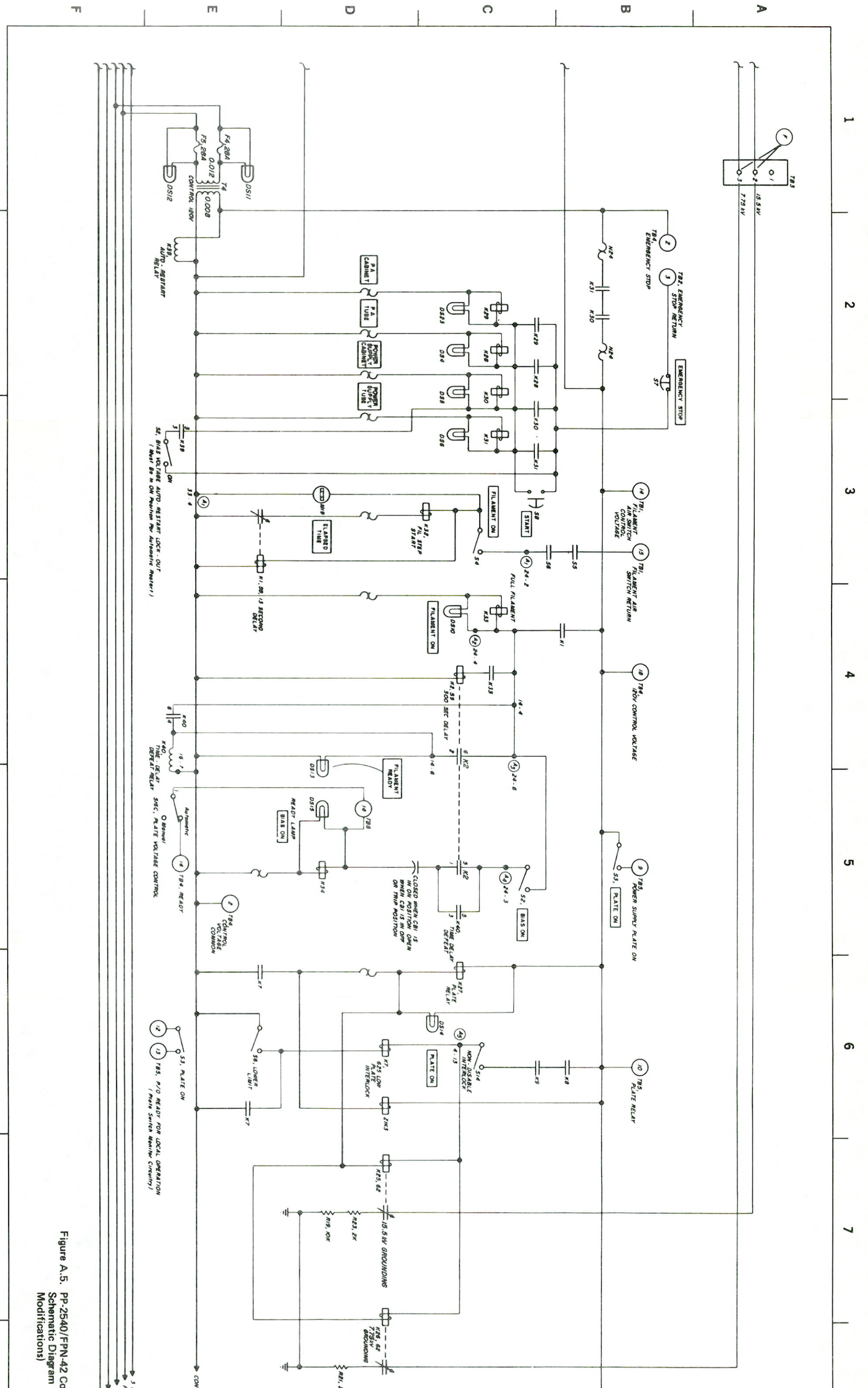
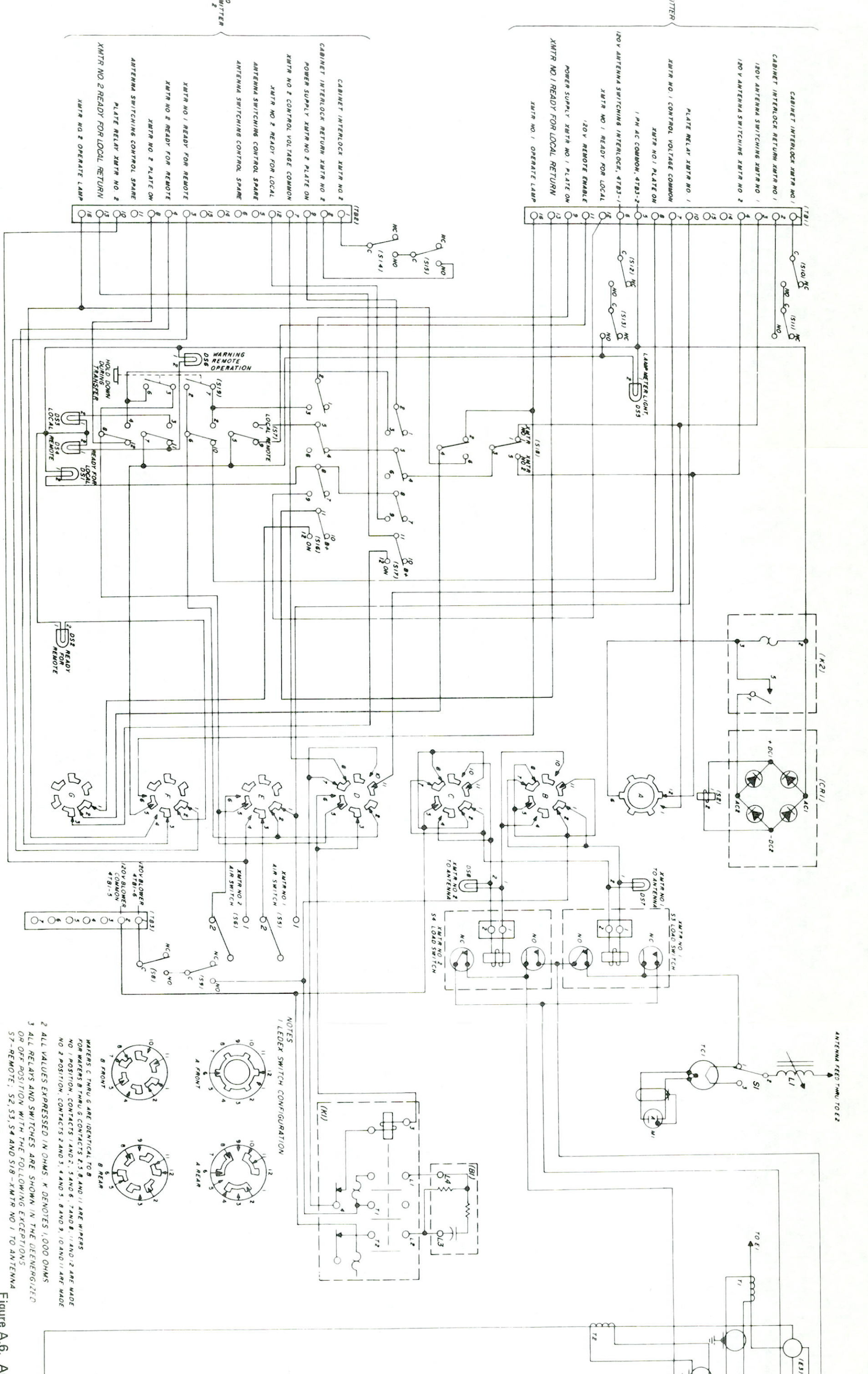


Figure A.5. PP-2540/FPN-4Z Control Schematic Diagram (Partic Modifications)



Circuit
Wiring Of LRE

A.11/A.12



NOTES

1. LEDER SWITCH CONFIGURATION

2. ALL VALUES EXPRESSED IN OHMS. K DENOTES 1,000 OHMS

3. ALL RELAYS AND SWITCHES ARE SHOWN IN THE DEENERGIZED OR OFF POSITION WITH THE FOLLOWING EXCEPTIONS

57-REMOTE; S2, S3, S4 AND S18-XMTR NO. 1 TO ANTENNA

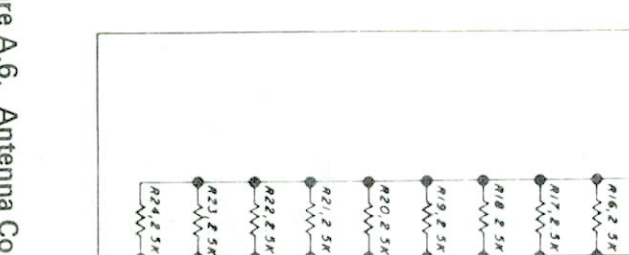


Figure A.6. Antenna Coup Wiring Diagram



er CU-807/FPN-42

A.13/A.14

PART LOCATION INDEX

REF. DESIG.	LOCATION	REF. DESIG.	LOCATION
C1	3B	R18	2C
C2	3F	R19	1B
C3	1E	R20	1B
C4	8F	R21	1C
C5	4B	R22	1C
C6	8F	R23	8D
C7	8D	R24	3E
C8	3E	R25	2D
C9	3E	R26	2D
C10	NOT USED	R27	2D
C11	8F	R28	2D
C12	8F	R29	8D
C13	8F	R30	4E
CR1	1B	R31	4E
CR2	1C	R32	5E
CR3	1D	R33	7B
CR4	4D	R34	7B
CR5	7B	S1	5A
CR6	4E	S2	8B
CR7	3E	TP1	2B
CR8	9D	TP2	2A
CR9	7E	TP3	4C
CR10	7F	TP4	4A
Q1	2B	TP5	5B
Q2	2C	TP6	5E
Q3	7B	TP7	8D
R1	2A	TP8	7E
R2	2C	TP9	7B
R3	3B	TP10	1D
R4	1E	U1	1E,3B
R5	4A	U2	4B,5D
R6	5C	U3	5B
R7	2B	U4	5B
R8	4B	U5	2A,2B,2C
R9	8A	U6	3B,4C
R10	8A	U7	5D
R11	8A	U8	5B
R12	8A	U9	3E,6B
R13	8B	U10	2D
R14	8B	U11	2D,4E,2E,3D
R15	8C	U12	3E,4E,5B,2C
R16	8C	U13	4E,6B,6D
R17	2A	U14	4E,6B,6D

A

B

C

D

E

F

MA DIFFERENTIALLY
TIVE AND THE MPTS ARE
ND THE MPTS ARE
RE CONNECTED TO
-12 VDC.

VALUES ARE IN μ F,
10⁸.

Modelo Schematic
A.15/A.19

PAR	
REF. DESIG.	LOCA
C1	1B
C2	2B
C3	2B
C4	3C
C5	3B
C6	4C
C7	4C
C8	6C
C9	6C
C10	6B
C11	4E
C12	1E
C13	7E
CR1	2E
CR2	2E
CR3	3E
CR4	3E
CR5	6E
CR6	6E
CR7	6E
CR8	6E
CR9	2E
CR10	6E
E1	1A
E2	7A
O1	2D
O2	2D
O3	6C
R1	1B
R2	1B
R3	1B
R4	2B
R5	2A
R6	2A
R7	3B
R8	4B
R9	4B
R10	4B
R11	5B
R12	5B
R13	6B
R14	6B
R15	6B
R16	6B

PART LOCATION INDEX		
LOCATION	REF. DESIG.	LOCATION
2D	R17	2D
2E	R18	2E
2E	R19	2E
2E	R20	2E
2E	R21	2E
2E	R22	2E
5C	R23	5C
6C	R24	6C
5E	R25	5E
5E	R26	5E
5E	R27	5E
5E	R28	5E
6E	R29	6E
7E	R30	7E
7E	R31	7E
4B	R32	4B
6C	R33	6C
6C	R34	6C
5B	S1	5B
6B	S2	6B
2A	TP1	2A
2A	TP2	2A
3A	TP3	3A
3A	TP4	3A
3A	TP5	3A
4A	TP6	4A
6A	TP7	6A
6A	TP8	6A
6A	TP9	6A
2A	TP10	2A
2B	U1	2B
2B	U2	2B
3B	U3	3B
5B	U4	5B
2C	U5	2C
2C	U6	2C
4C	U7	4C
5C	U8	5C
6C	U9	6C
3D	U10	3D
4D	U11	4D
5D	U12	5D
5D	U13	5D
6D	U14	6D

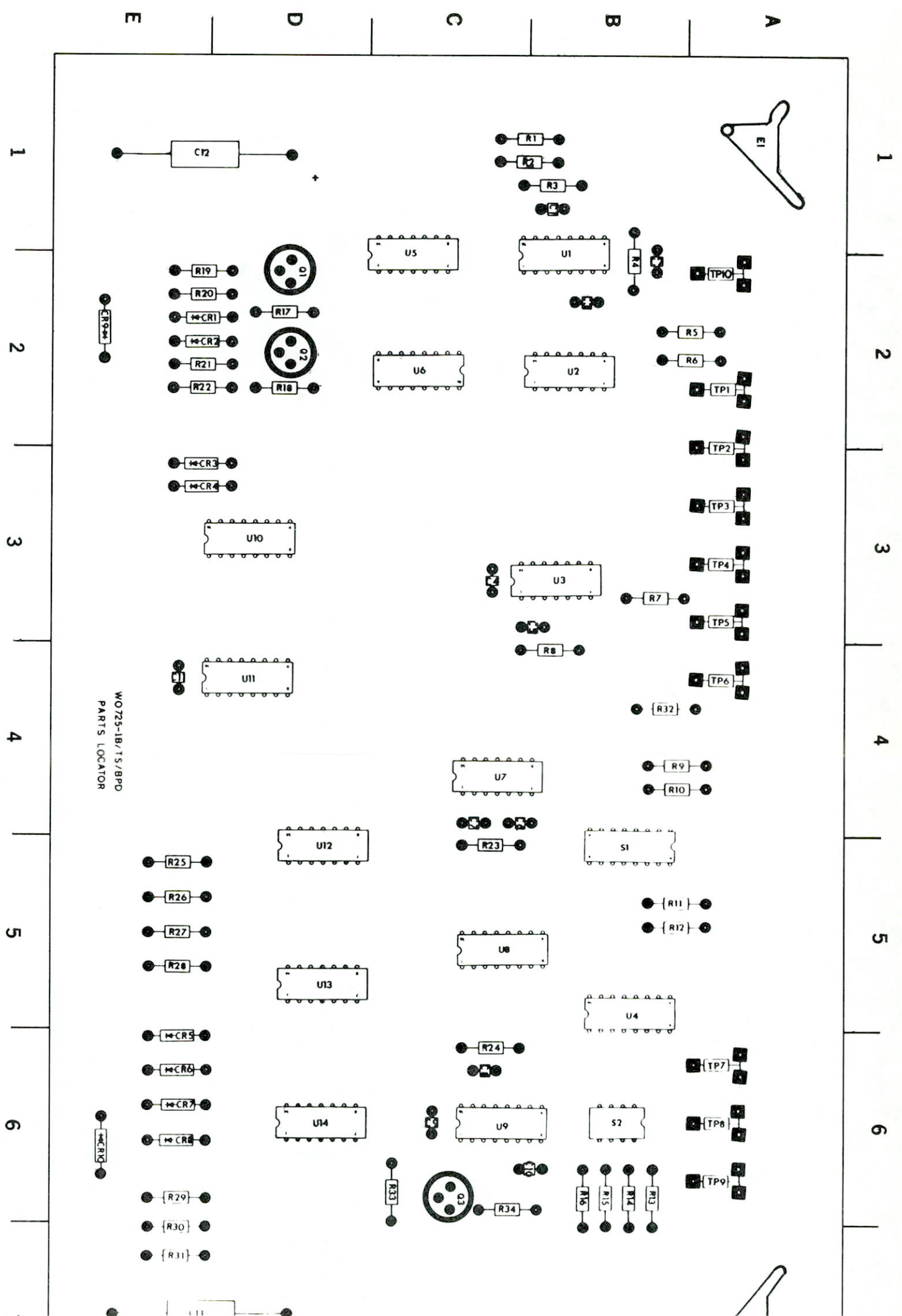
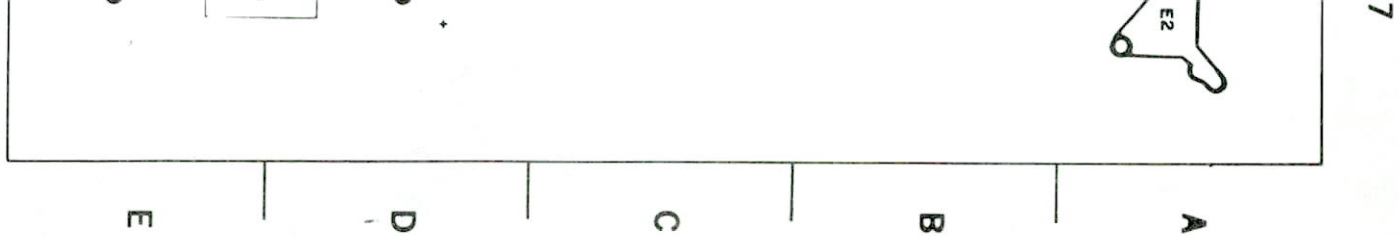
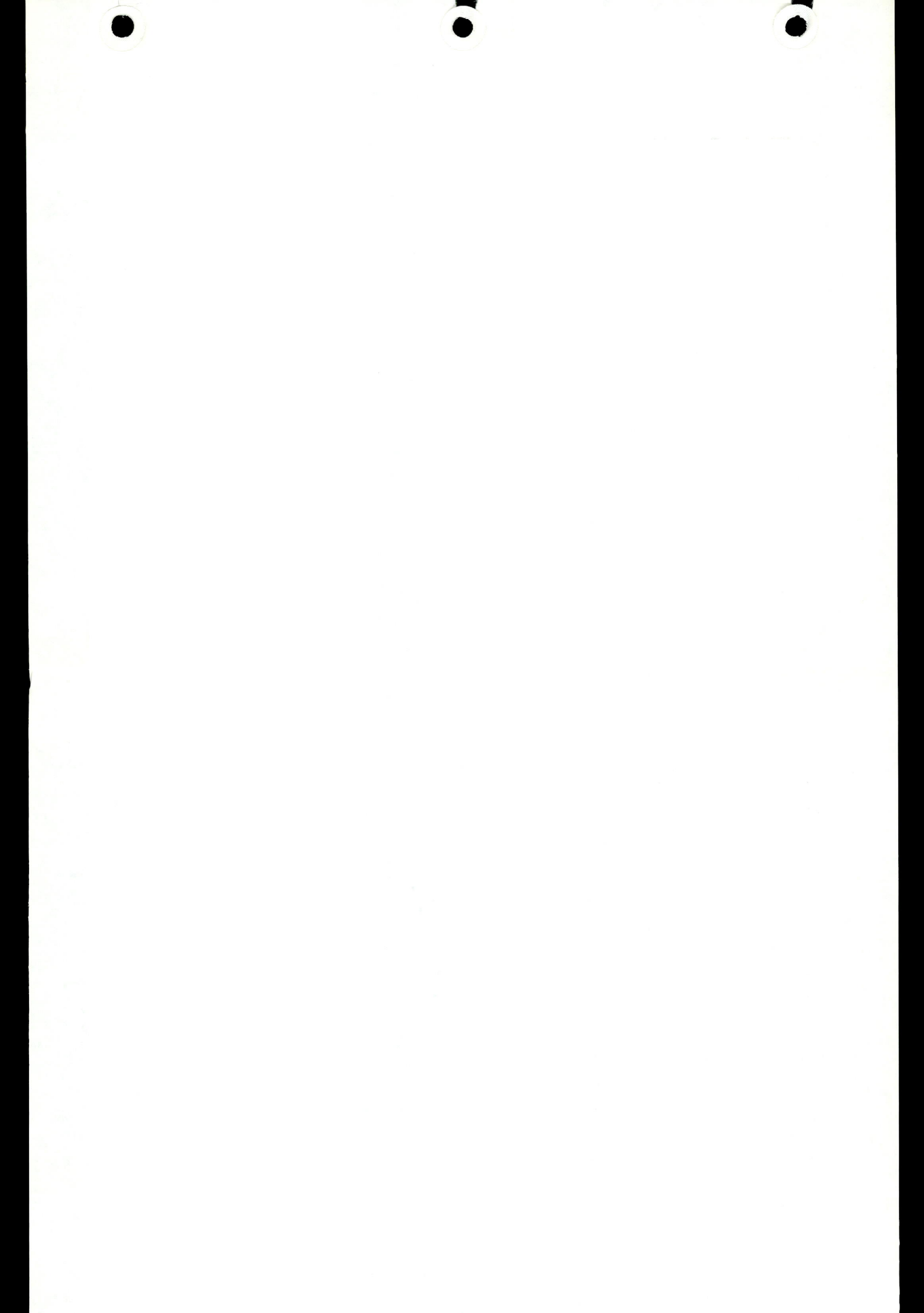


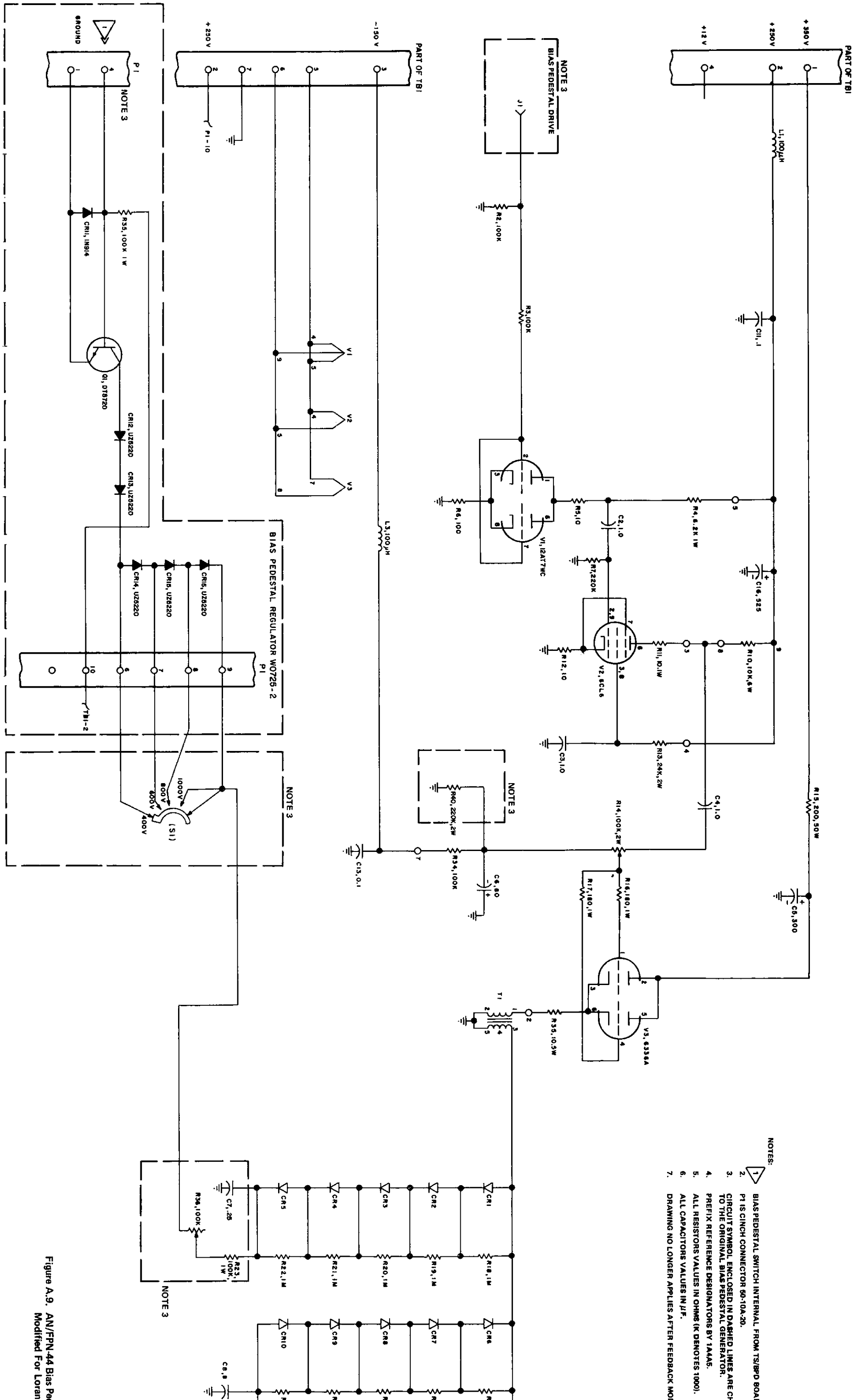
Figure A.8. W0725-1B/TS/BPD Parts Locator



/TS/BPD Module
tor

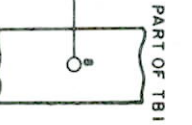
A.17/A.18





- NOTES:
1. BIAS PEDESTAL SWITCH INTERNAL FROM TS/PPD BOARD
 2. P1 IS CINCH CONNECTOR 80-10A-20.
 3. CIRCUIT SYMBOL ENCLOSED IN DASHED LINES ARE CHA TO THE ORIGINAL BIAS PEDESTAL GENERATOR.
 4. PREFIX REFERENCE DESIGNATORS BY 1A4A5.
 5. ALL RESISTOR VALUES IN OHMS (K DENOTES 1000).
 6. ALL CAPACITOR VALUES IN μ F.
 7. DRAWING NO LONGER APPLIES AFTER FEEDBACK MOD.

Figure A.9. AN/FN-44 Bias Pedestal Drive
Modified For Loran F

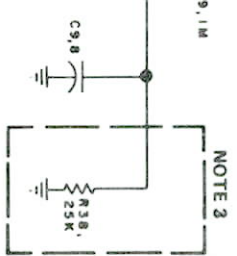


5.1M

5.1M

7.1M

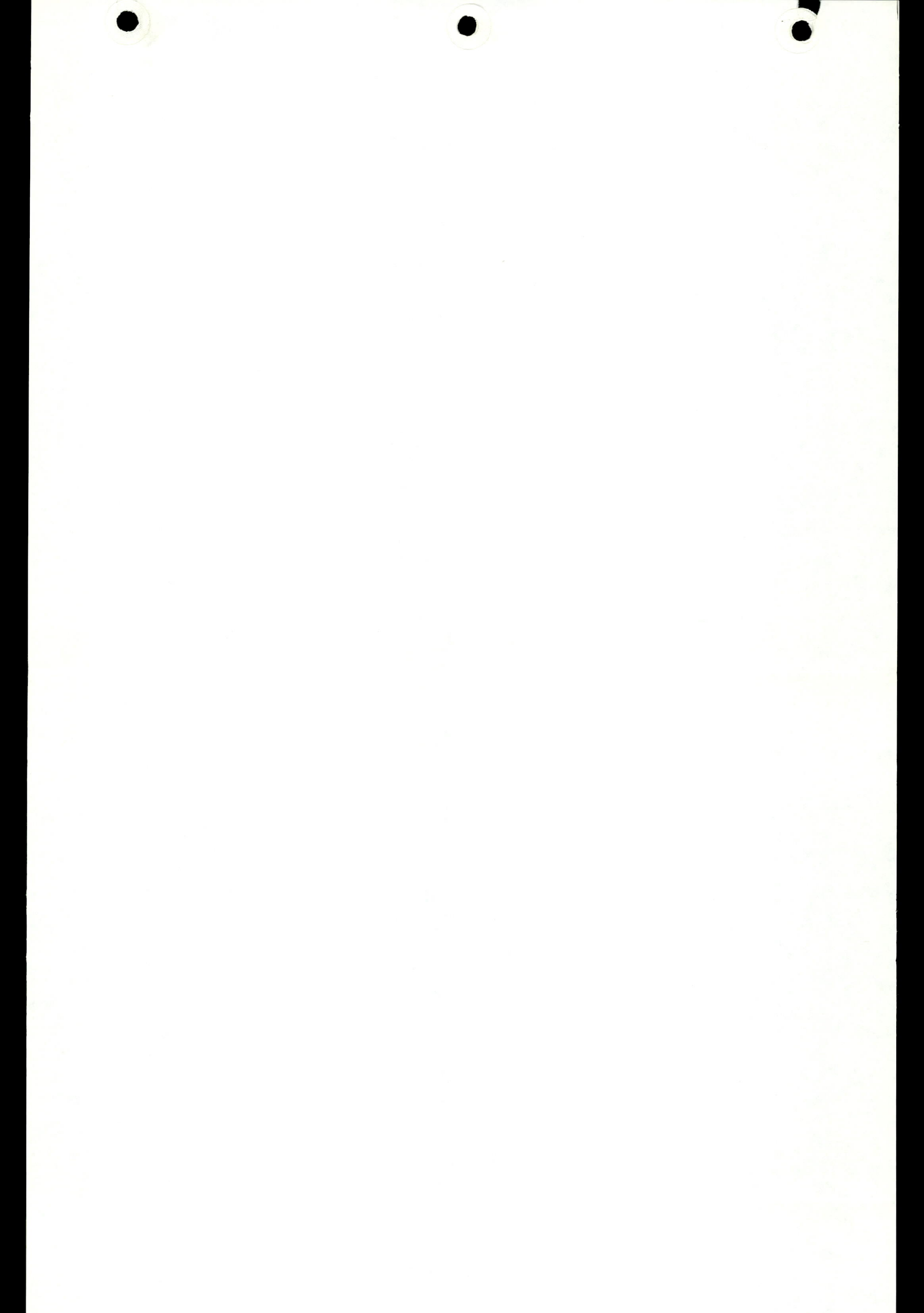
9.1M



9.1M

Crystal Generator
Replacement Equipment

A.19/A.20



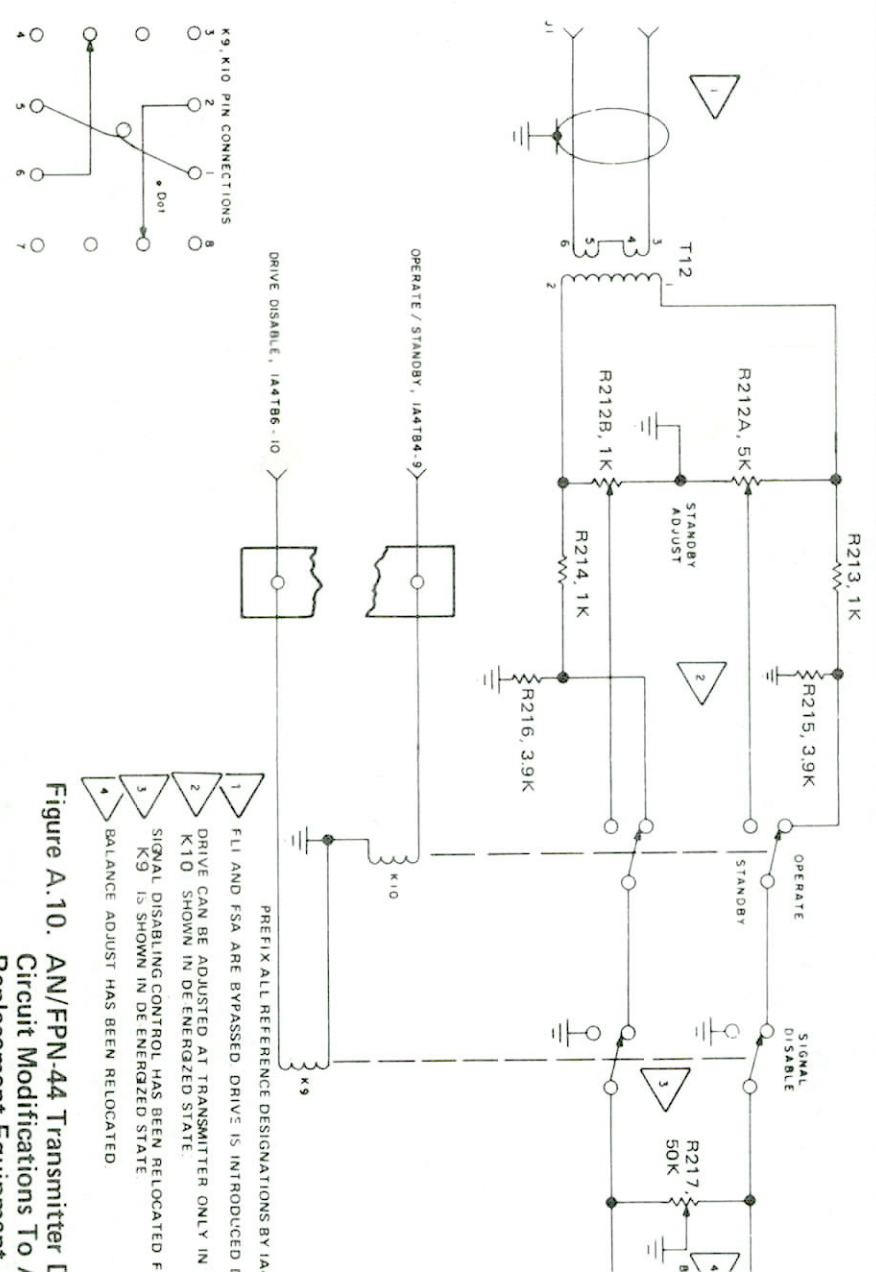
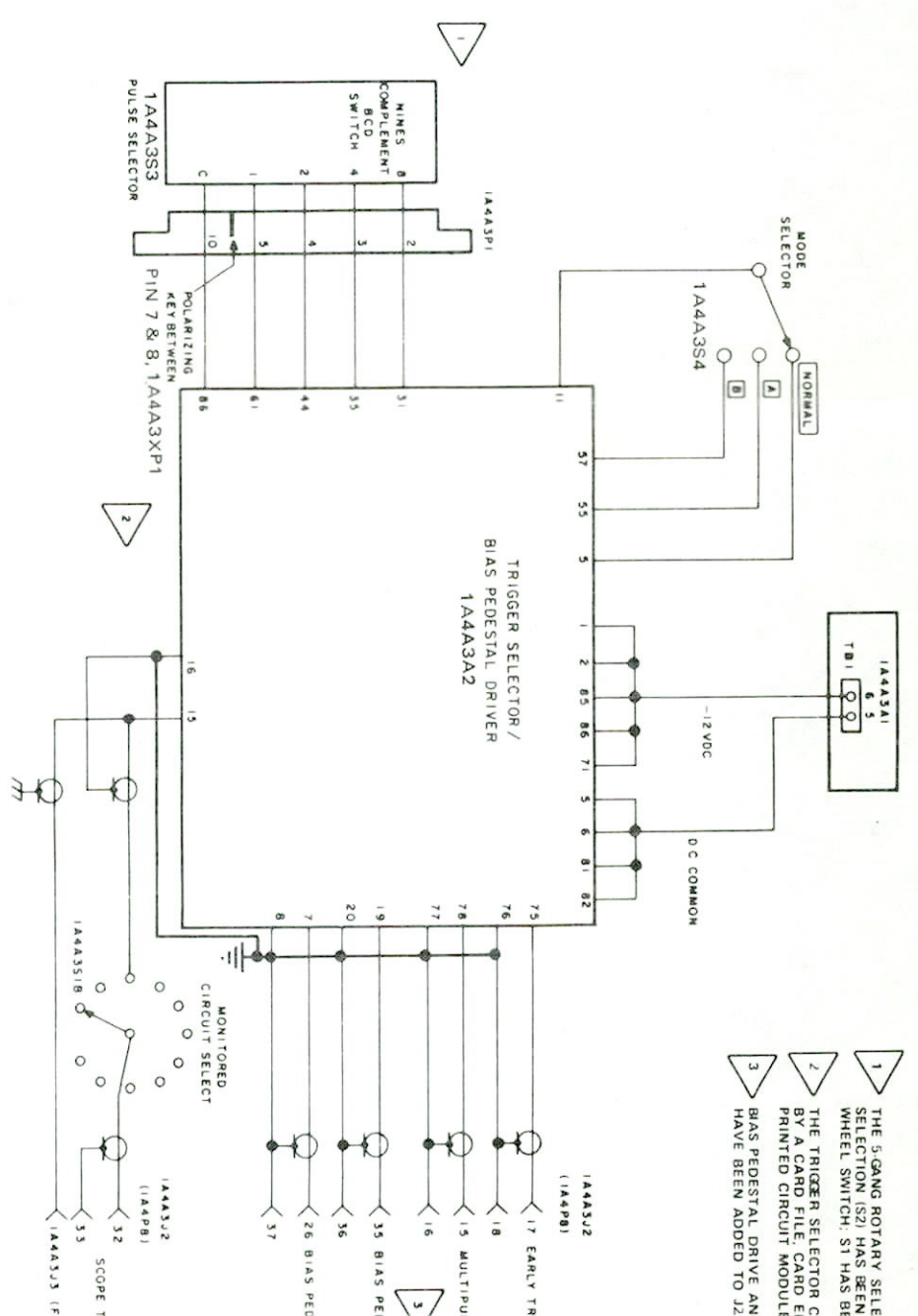
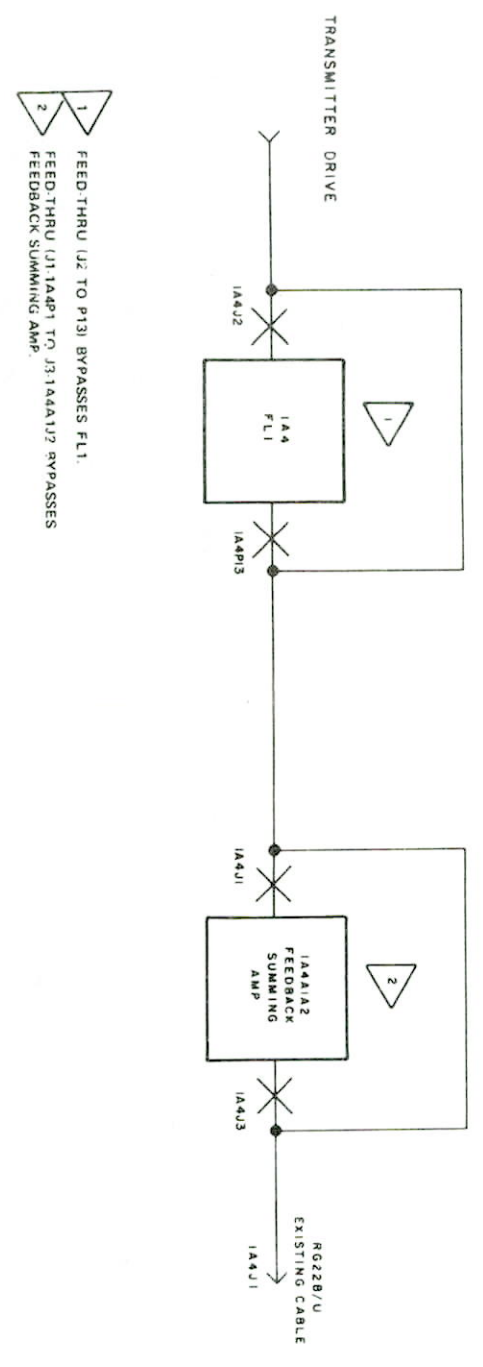
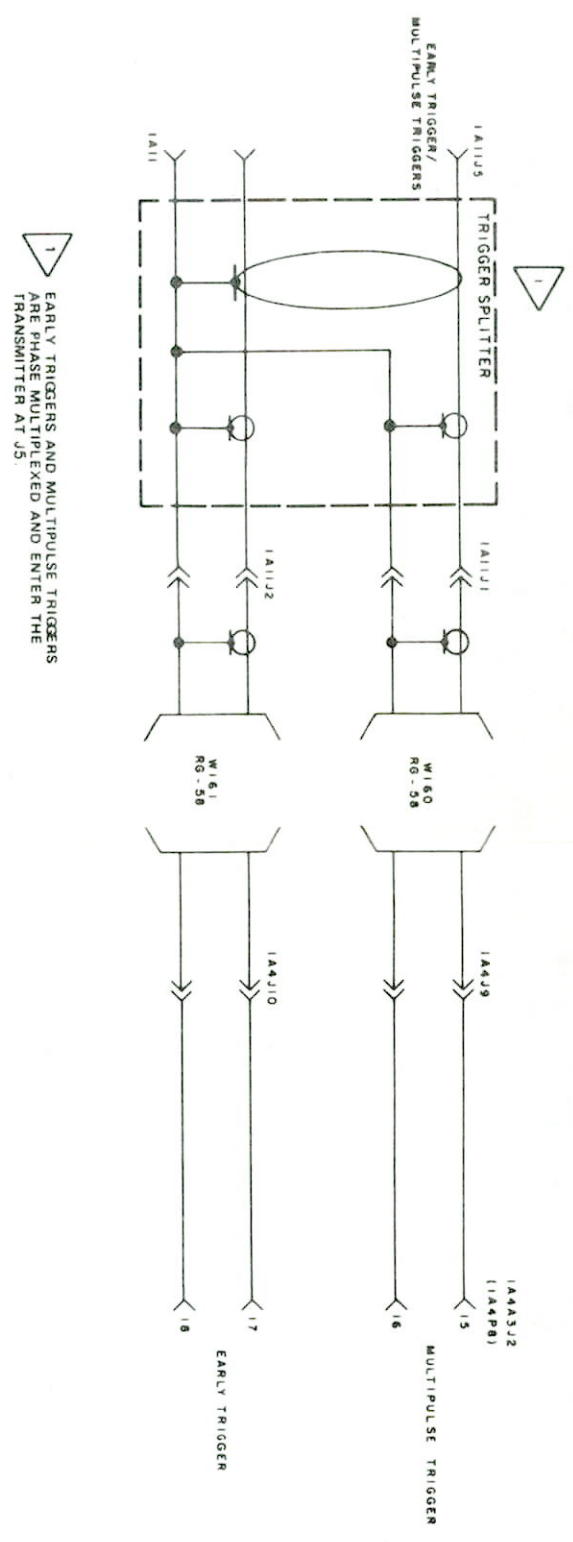


Figure A. 10. AN/FPN-44 Transmitter L
Circuit Modifications To /
Replacement Equipment

CTOR SWITCH FOR PULSE
REPLACED BY A THUMB.
EEN REWIRED.

HASSIS HAS BEEN REPLACED
DGE CONNECTOR, AND

D INTERVAL WAVEFORMS

IGGER

LSE TRIGGER

DESTAL DRIVE

DESTAL INTERVAL

RIGGER

FRONT PANEL TRIGGER OUT 1

C2, .1

SEE FIGURE 6-48 OF
FPN-44 TECH MANUAL

C1, .1

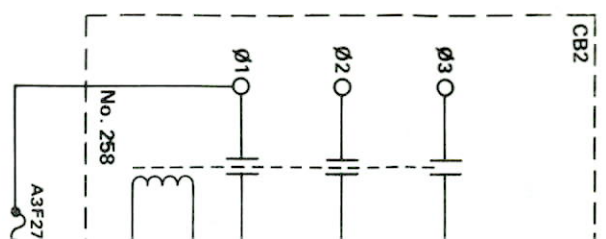
ROM FSA.

STANDBY MODE

DIRECTLY AT J1

Drive and Trigger
Accommodate Loran

A.21/A.22



→ TB61.9
NOTE 2

1TB24.3

SA, PLATE REGULATOR
LOWER SWITCH
(CLOSED IN MAX.
LOWER POSITION)

ACTOR

CAPACITOR
E CONTACTOR

31.3

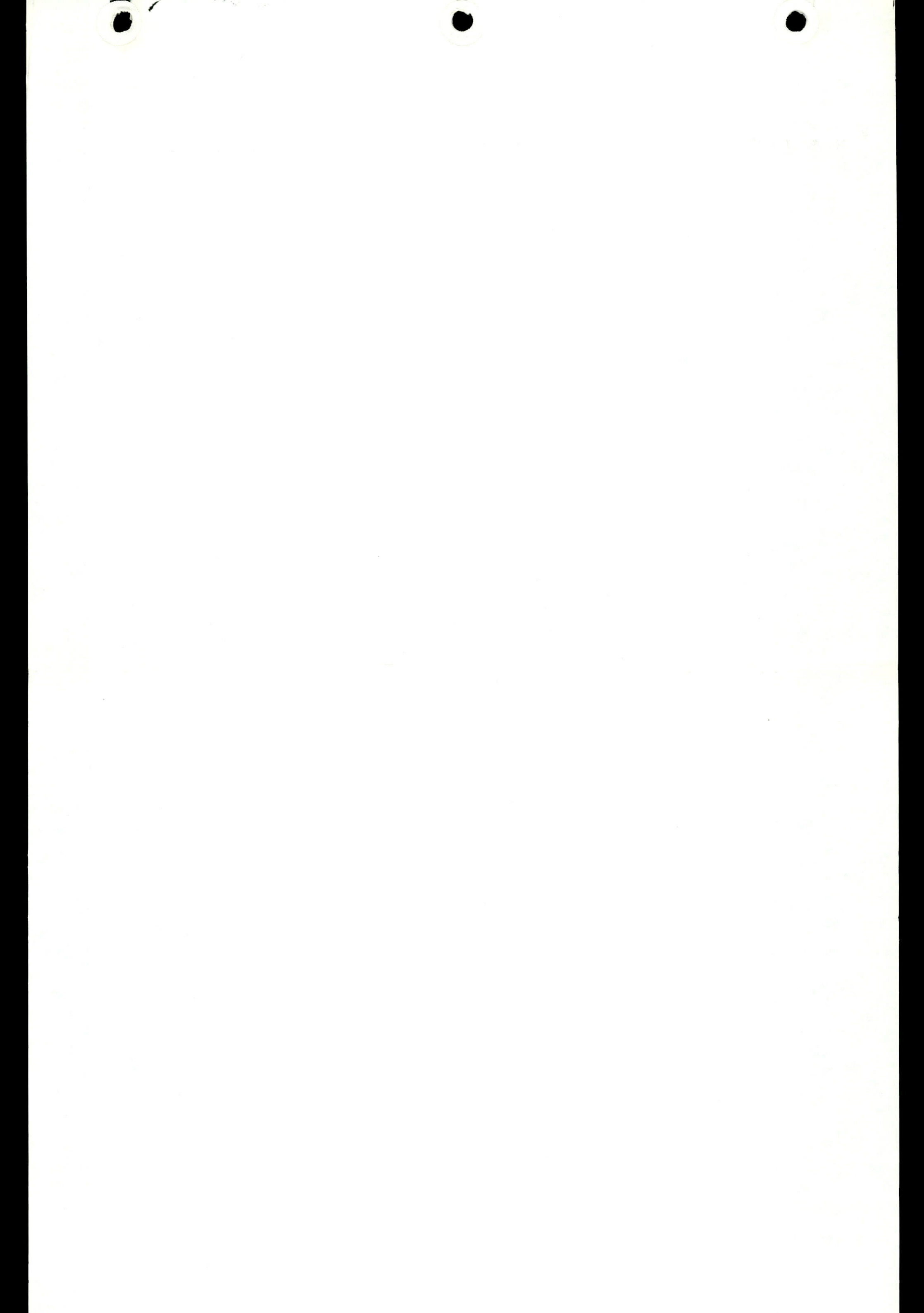
TO SHEET 4

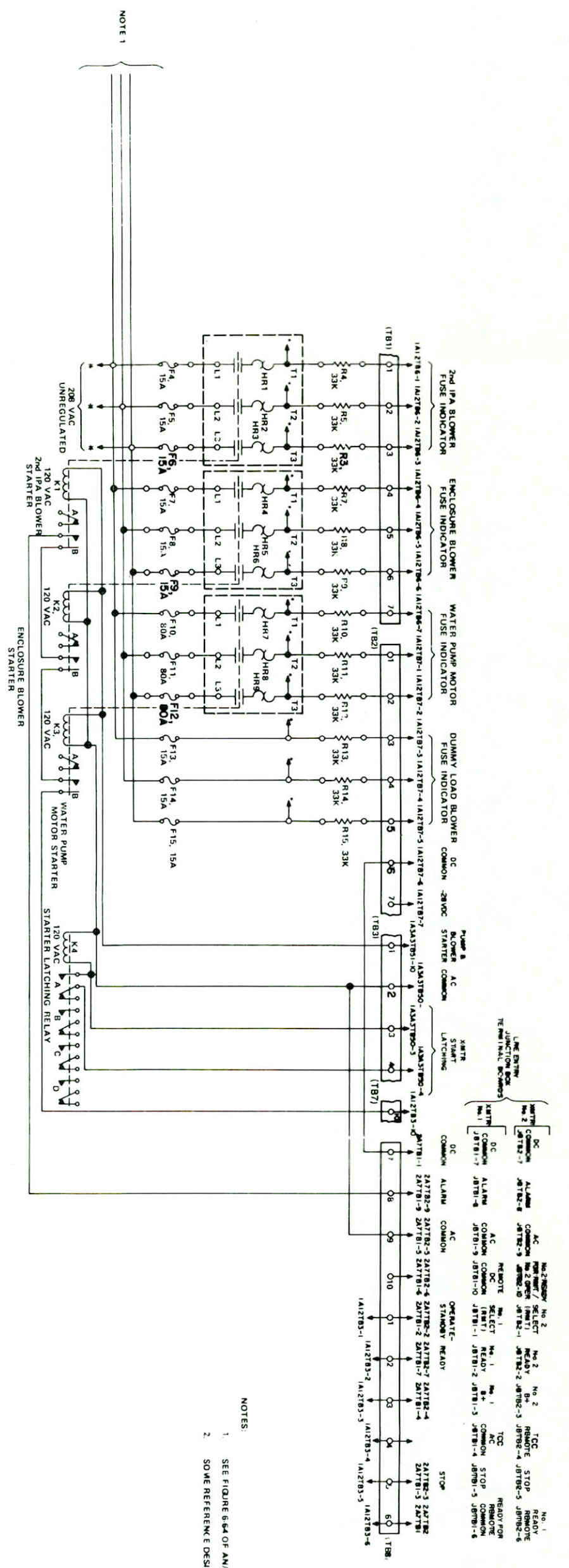
→ D NOTE 2
TRIKE LOCKOUT RELAY

→ TB60.7
NOTE 2

Quirry (K39 and K40)

A.23/A.24

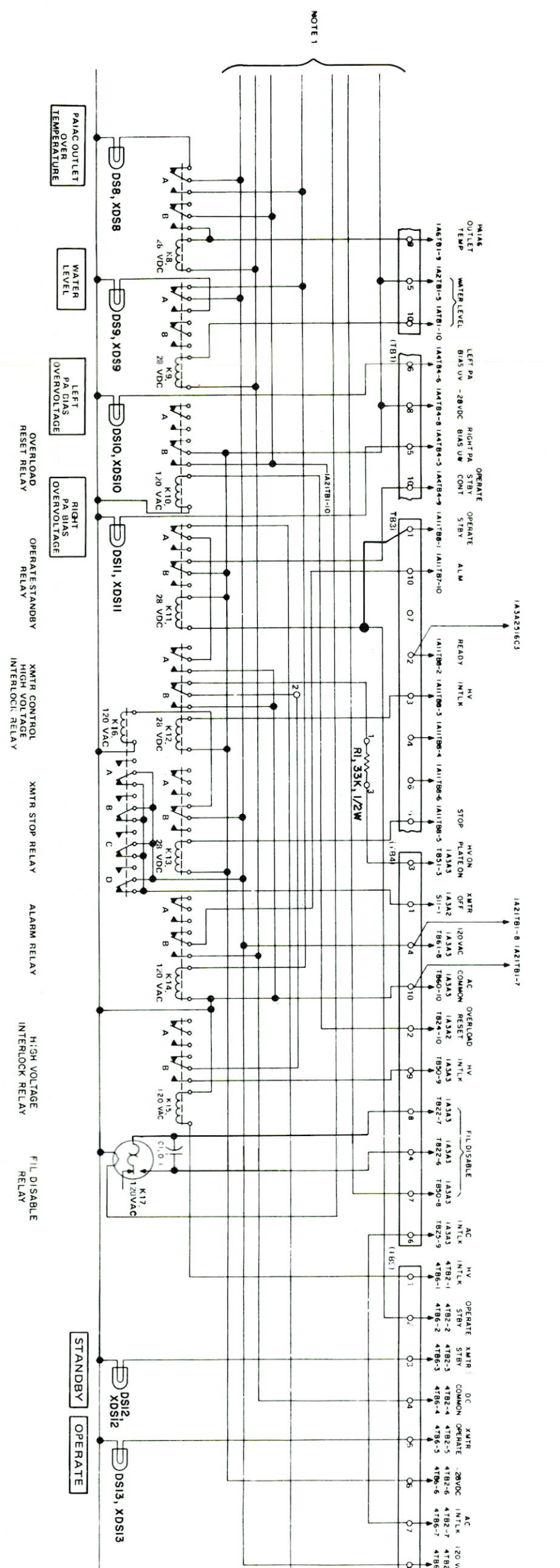




NOTE 1

TRANSMITTER CONTROL WIRING (1A11) CHANGES FOR INSTALLATION

- NOTES:
- SEE FIGURE 6-4 OF AN/FPM 44 TECHNICAL MANUAL.
 - SOME REFERENCE DESIGNATORS ARE ABBREVIATED. PREFIX



NOTE 1

- NOTES:
- SEE FIGURE 6-4 OF AN/FPM 44 TECHNICAL MANUAL.
 - SOME REFERENCE DESIGNATORS ARE ABBREVIATED. PREFIX

Figure A.12. Transmitter Control Wiring Changes For Installation Of

WITH 1A11.

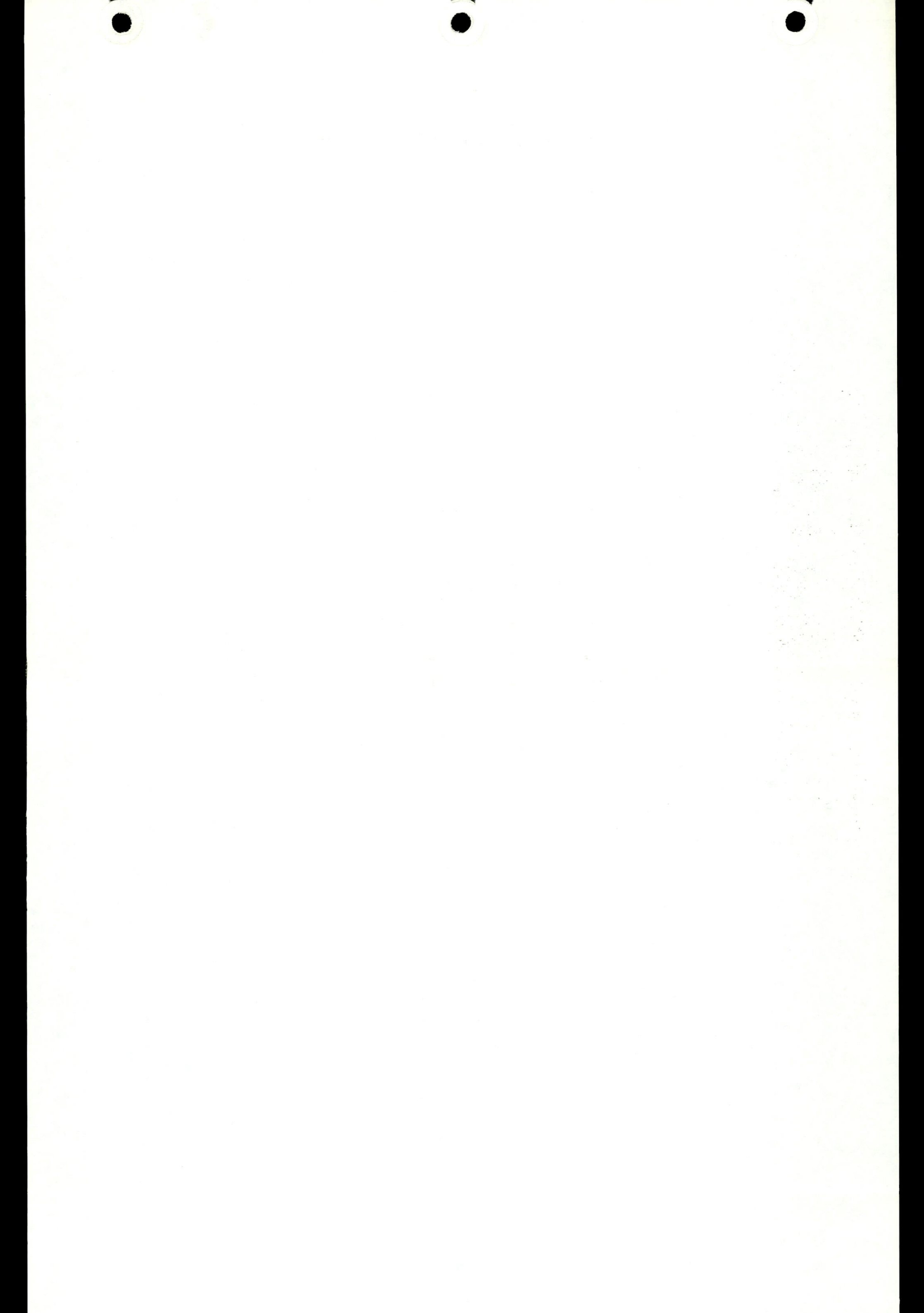
OF LRE/AN/FPN-44

IA3A8T25 - 12

6-66 OF AN/FPN-44
MANUAL.
RENCE DESIGNATORS
VIATED, PREFIX

(1A12)
LRE/AN/FPN-44

A.25/A.26



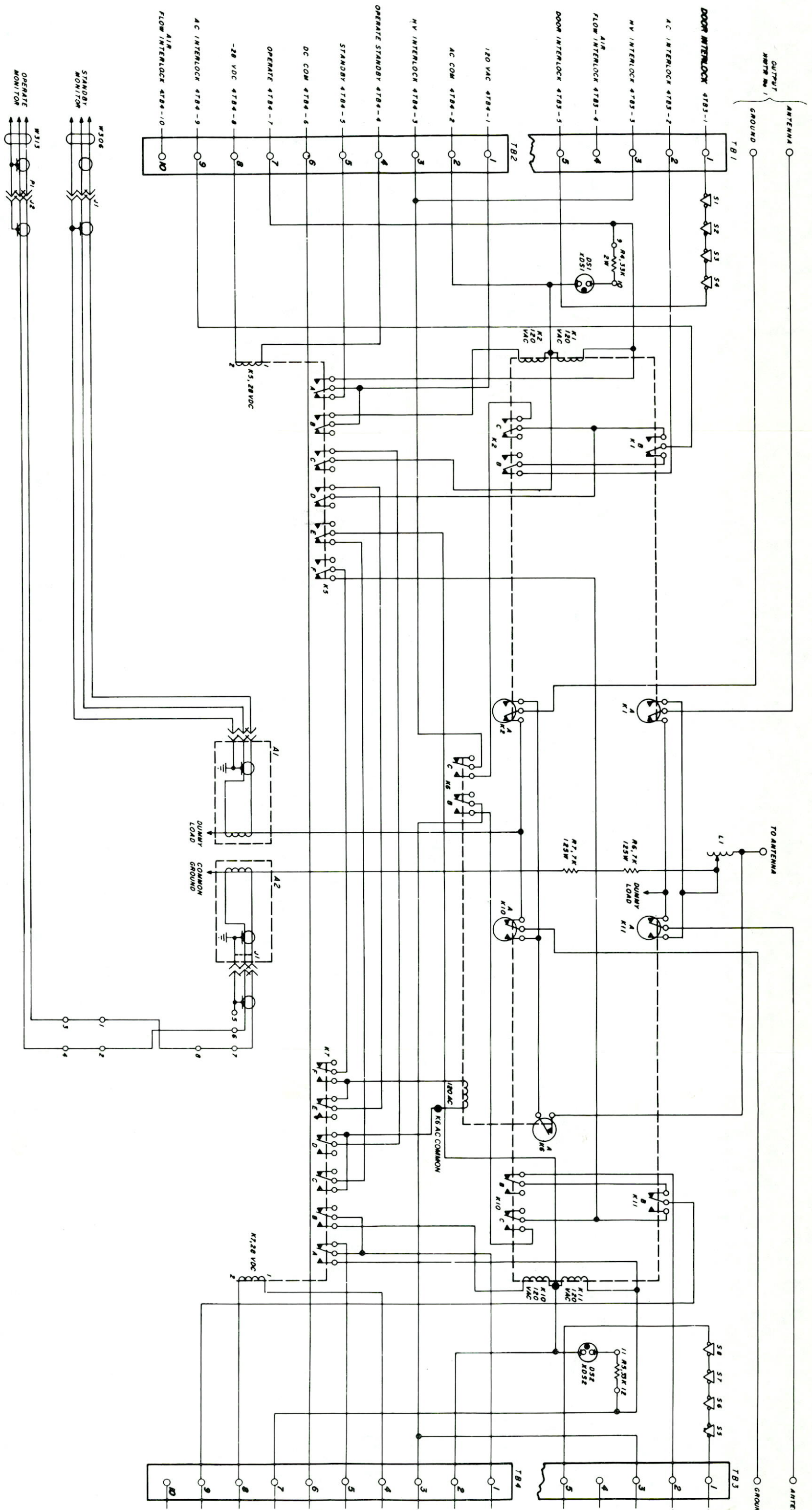


Figure A.13. LRE/AN/FPN-44 A Wiring Diagram

OUTPUT
ANTENNA NO. 2

110

4T007-1 DOOR INTERLOCK

4T007-2 AC INTERLOCK

4T007-3 HV INTERLOCK

4T007-4 FLOW INTERLOCK
AIR

4T007-5 DOOR INTERLOCK

4T000-1 120 VAC

4T000-2 AC COM

4T000-3 HV INTERLOCK

4T000-4 OPERATE STANDBY

4T000-5 DC COMMON

4T000-6 AC INTERLOCK

4T000-7 AC INTERLOCK

4T000-8 -20 VDC

4T000-9 AC INTERLOCK

4T000-10 FLOW INTERLOCK
AIR

Antenna Coupler (3)

A.27/A.28

PART LOCATION INDEX	
REF. DESIG.	LOCATION
CR1	4E
CR2	6E
DS1	2B
DS2	2D
DS3	2C
DS4	2C
DS5	2D
DS6	3A
DS7	3A
K1	6B
K2A	3D
K2B	6D
S1A	3E
S1B	3E
S1C	3E
S1D	3E
S2A	5E
S2B	5E
S2C	5E
S2D	5D
S3A	6E
S3B	6E
S3C	6E
S3D	6E
S4	3F
S5	6D
S6	6F
TB1	7A
TB2	7A

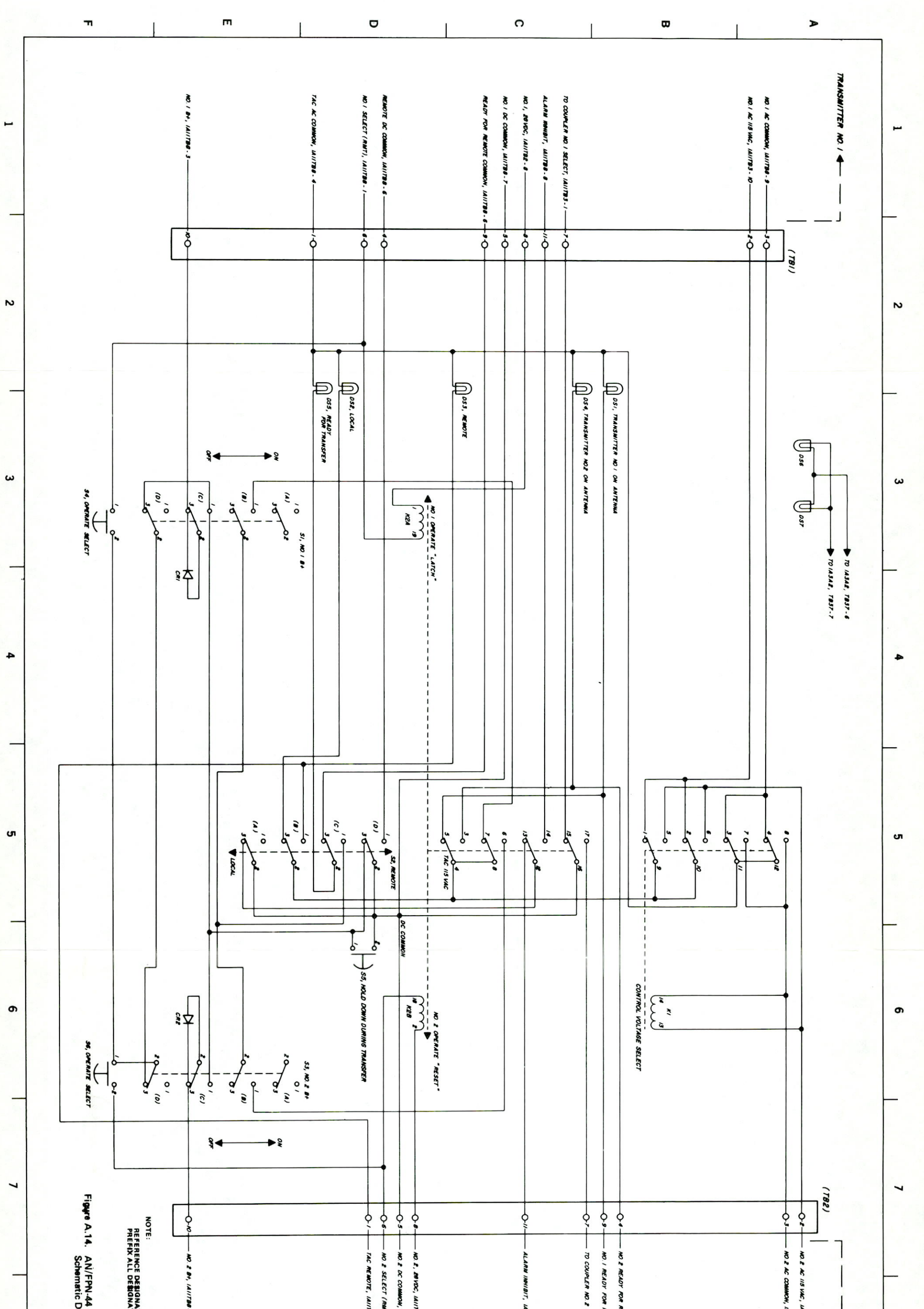


Figure A.14. AN/FPN-44 Local Control Unit Schematic Diagram

NOTE:
 REFERENCE DESIGNATIONS ARE ABBREVIATED
 PREFIX ALL DESIGNATIONS WITH S.

NO. 2

A

LAITBO - 10

B

C

D

E

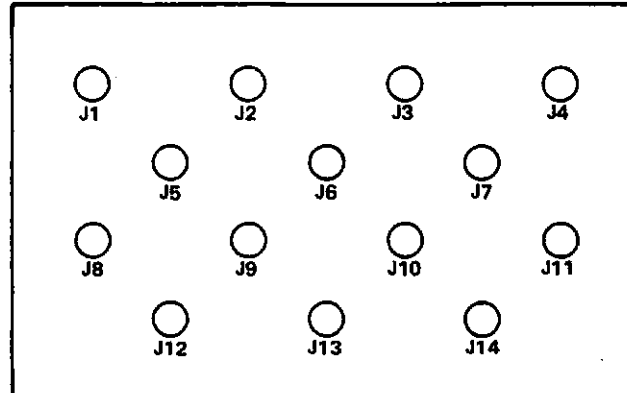
LAITBO.

hit (UD B)

F

A.28/A.39

TWINAX CONNECTIONS FOR SCREEN ROOM JUNCTION BOX



(VIEWED FROM OUTSIDE)

SINCE JUNCTION BOX WAS NOT LABELED BY MANUFACTURER LABEL THE TWIN-AX CONNECTORS AS SHOWN. THEN DEDICATE THE CONNECTORS AS FOLLOWS:

- J1 XMTR 1 DRIVE
- J2 XMTR 1 ET/EMPT
- J5 OPERATE RF
- J8 XMTR 2 DRIVE
- J9 XMTR 2 ET/EMPT
- J12 DUMMY LOAD RF
- J14 RF FROM REC. ANTENNA

Figure A.15. Screen Room Junction Box

